



QNPXY Hardware Manual

Revision: 1.02.00



Global Technical Support

Go to www.aerotech.com/global-technical-support for information and support about your Aerotech products. The website provides downloadable resources (such as up-to-date software, product manuals, and Help files), training schedules, and PC-to-PC remote technical support. You can also complete Product Return (RMA) forms and get information about repairs and spare or replacement parts. For immediate help, contact a service office or your sales representative. Have your customer order number available before you call or include it in your email.

United States (World Headquarters)	
Phone: +1-412-967-6440 Fax: +1-412-967-6870 Email: service@aerotech.com	101 Zeta Drive Pittsburgh, PA 15238-2811 www.aerotech.com
United Kingdom	Japan
Phone: +44 (0)1256 855055 Fax: +44 (0)1256 855649 Email: service@aerotech.co.uk	Phone: +81 (0)50 5830 6814 Fax: +81 (0)43 306 3773 Email: service@aerotechkk.co.jp
Germany	China
Phone: +49 (0)911 967 9370 Fax: +49 (0)911 967 93720 Email: service@aerotechgmbh.de	Phone: +86 (21) 3319 7715 Email: service@aerotech.com
France	Taiwan
Phone: +33 2 37 21 87 65 Email: service@aerotech.co.uk	Phone: +886 (0)2 8751 6690 Email: service@aerotech.tw

This manual contains proprietary information and may not be reproduced, disclosed, or used in whole or in part without the express written permission of Aerotech, Inc. Product names mentioned herein are used for identification purposes only and may be trademarks of their respective companies.

Copyright © 2015-2017, Aerotech, Inc., All rights reserved.

Aerotech Worldwide

United States ■ France ■ Germany ■ United Kingdom
China ■ Japan ■ Taiwan



Table of Contents

- QNPXY Hardware Manual** **1**
 - Table of Contents 3
 - List of Figures 5
 - List of Tables 6
 - Safety Procedures and Warnings 7
 - EU Declaration of Conformity 8
- Chapter 1: Overview** **9**
 - 1.1. Understanding Basic QNPXY Stage Operation 10
 - 1.2. Environmental Specifications 11
 - 1.3. Linearity and Temperature Effects 12
 - 1.4. Basic Specifications 13
 - 1.5. Vacuum Operation 14
- Chapter 2: Mechanical Specifications and Installation** **15**
 - 2.1. Unpacking and Handling the Stage 15
 - 2.2. Dimensions 16
 - 2.3. Securing the Stage to the Mounting Surface 17
 - 2.4. Attaching the Payload to the Stage 19
 - 2.5. Load Capability 21
 - 2.6. Cable Bend Radius 28
- Chapter 3: Electrical Specifications and Installation** **29**
 - 3.1. Piezo Connectors 30
 - 3.2. Piezo Wiring 32
 - 3.3. Electrical Specifications 33
 - 3.4. Machine Direction 34
 - 3.5. Travel Limits 35
- Chapter 4: Maintenance** **37**
 - 4.1. Service and Inspection Schedule 37
 - 4.2. Cleaning and Lubrication 37
 - 4.3. Poling the Piezo Actuator 38
 - 4.4. Troubleshooting 39
- Appendix A: Warranty and Field Service** **41**
- Appendix B: Revision History** **43**
- Appendix C: Piezo Engineering Tutorial** **45**
 - C.1 The Direct and Inverse Piezoelectric Effect 45
 - C.2 Piezo Actuator Materials 45
 - C.2.1 RoHS Exemption 45
 - C.3 Properties of Piezo Actuators 45
 - C.3.1 Displacement Performance 45
 - C.3.2 Hysteresis Effects 46
 - C.3.3 Creep and Drift 48
 - C.3.4 Force and Displacement 48
 - C.3.4.1 Force Versus Displacement Characteristics 48
 - C.3.4.2 Displacement With a Constant External Load 49
 - C.3.4.3 Displacement With an External Spring Load 50
 - C.3.5 Capacitance 51
 - C.3.6 Heating and Power Dissipation 52
 - C.3.7 Environmental Effects 53

- C.3.7.1 Humidity 53
- C.3.7.2 Temperature 53
- C.3.7.3 Vacuum 54
- C.4 Piezo Stage Properties and Nomenclature 54
 - C.4.1 Accuracy/Linearity 54
 - C.4.2 Resolution 56
 - C.4.3 Repeatability 57
 - C.4.4 Stiffness 57
 - C.4.5 Resonant Frequency 57
 - C.4.6 Load Ratings 58
 - C.4.7 Expected Lifetime 58
- C.5 Amplifier Selection 59
- Index 63**

List of Figures

Figure 1-1:	Single-Axis Stage Travel and Voltage Relationship	10
Figure 2-1:	Dimensions	16
Figure 2-2:	Mounting Plate (-MP) Dimensions	16
Figure 2-3:	Mounting Hole Locations	18
Figure 2-4:	Mounting Hole Locations (Tabletop)	20
Figure 2-5:	Offset Load Principal Directions	21
Figure 2-6:	QNP40XY-100, 1st Natural Frequencies for Point Load Offset from Tabletop Center in Horizontal Direction (HR and HP)	22
Figure 2-7:	QNP40XY-100, 1st Natural Frequencies for Point Load Offset from Tabletop Center in Vertical Direction	23
Figure 2-8:	QNP50XY-250, 1st Natural Frequencies for Point Load Offset from Tabletop Center in Horizontal Direction (HR and HP)	24
Figure 2-9:	QNP50XY-250, 1st Natural Frequencies for Point Load Offset from Tabletop Center in Vertical Direction	25
Figure 2-10:	QNP60XY-500, 1st Natural Frequencies for Point Load Offset from Tabletop Center in Horizontal Direction (HR and HP)	26
Figure 2-11:	QNP60XY-500, 1st Natural Frequencies for Point Load Offset from Tabletop Center in Vertical Direction	27
Figure 3-1:	Piezo Actuator Wiring	32
Figure 3-2:	Machine Direction	34
Figure C-1:	Strain (displacement) behavior of a ferroelectric material like PZT with an applied electric field driven to its excitation limits	46
Figure C-2:	Typical hysteresis curve of a piezoelectric stack actuator operating from -30V to +150V ..	47
Figure C-3:	Force vs. displacement output of a piezo actuator at various applied voltages	48
Figure C-4:	Displacement of a piezo stage or actuator with a constant external load	49
Figure C-5:	Displacement of a piezo stage or actuator driving against an external spring of stiffness k_e	50
Figure C-6:	Estimated power dissipated as a function of frequency and applied voltage for a typical piezo actuator with a 4 μ F capacitance	53
Figure C-7:	Raw measurement results from an accuracy and linearity test of a 100 μ m piezo stage ..	55
Figure C-8:	Example accuracy error calculated from the measurement data shown in Figure 1-7	56
Figure C-9:	Illustration showing how linearity is calculated based on measurement data taken from a 100 μ m piezo nanopositioning stage	56
Figure C-10:	Maximum sinusoidal peak-peak voltage of a given amplifier with various piezo stack capacitances	60
Figure C-11:	Voltage and current waveforms for the profile commanded in Example 1	61
Figure C-12:	Voltage and current waveforms for the profile commanded in Example 2	62

List of Tables

Table 1-1: Model Numbers and Options 9
Table 1-2: Minimum Acceptable Environmental Specifications11
Table 1-3: QNPXY Series Specifications13
Table 2-1: Stage to Mounting Surface Hardware17
Table 2-2: Customer Mounting Features20
Table 3-1: Piezo Connector Pin Description31
Table 3-2: Electrical Specifications33
Table 4-1: Troubleshooting39

Safety Procedures and Warnings

Read this manual in its entirety before installing, operating, or servicing this product. If you do not understand the information contained herein, contact an Aerotech representative before proceeding. Strictly adhere to the statements given in this section and other handling, use, and operational information given throughout the manual to avoid injury to you and damage to the equipment.

The following statements apply wherever the Warning or Danger symbol appears within this manual. Failure to observe these precautions could result in serious injury to those individuals performing the procedures and/or damage to the equipment.



DANGER: This product contains potentially lethal voltages. To reduce the possibility of electrical shock, bodily injury, or death the following precautions must be followed.

1. Access to the QNPXY and component parts must be restricted while connected to a power source.
2. Do not connect or disconnect any electrical components or connecting cables while connected to a power source.
3. Disconnect electrical power before servicing equipment.
4. All components must be properly grounded in accordance with local electrical safety requirements.
5. Operator safeguarding requirements must be addressed during final integration of the product.



WARNING: To minimize the possibility of electrical shock, bodily injury or death the following precautions must be followed.

1. Cables can pose a tripping hazard. Securely mount and position all system cables to avoid potential hazards.
2. Do not expose this product to environments or conditions outside of the listed specifications. Exceeding environmental or operating specifications can cause damage to the equipment.
3. The QNPXY stage must be mounted securely. Improper mounting can result in injury and damage to the equipment.
4. Use care when moving the QNPXY stage. Lifting or transporting the QNPXY stage improperly can result in injury or damage to the QNPXY.
5. This product is intended for light industrial manufacturing or laboratory use. Use of this product for unintended applications can result in injury and damage to the equipment.
6. If the product is used in a manner not specified by the manufacturer, the protection provided by the product can be impaired and result in damage, shock, injury, or death.
7. Do not operate the QNPXY at higher voltages or different polarity than stated in to prevent damage to the stage.
8. Do not disassemble the QNPXY. Disassembly could expose the user to high voltages. Disassembly will result in a loss of linearity and void the warranty.
9. Do not exceed the maximum push/pull forces stated in to avoid damaging the piezo drives or misadjusting the positioner.
10. Do not drop the QNPXY or subject it to any mechanical shock to avoid damaging sensitive internal components.
11. Operators must be trained before operating this equipment.
12. All service and maintenance must be performed by qualified personnel.

EU Declaration of Conformity

Manufacturer Aerotech, Inc.
Address 101 Zeta Drive
 Pittsburgh, PA 15238-2811
 USA
Product QNPXY
Model/Types All

This is to certify that the aforementioned product is in accordance with the applicable requirements of the following Directive(s):

2014/35/EU	Low Voltage Directive LVD
2011/65/EU	RoHS 2 Directive

and has been designed to be in conformity with the applicable requirements of the following documents when installed and used in accordance with the manufacturer’s supplied installation instructions.

EN 61010-1:2010	Safety requirements for electrical equipment
-----------------	--

Name  / Alex Weibel
Position Engineer Verifying Compliance
Location Pittsburgh, PA

Chapter 1: Overview

NOTE: Aerotech continually improves its product offerings; listed options may be superseded at any time. All drawings and illustrations are for reference only and were complete and accurate as of this manual's release. Refer to www.aerotech.com for the most up-to-date information.

Table 1-1: Model Numbers and Options

QNPXY Series Two-Axis Piezo Nanopositioning Stage	
QNP40XY-100	100 μm x 100 μm closed-loop travel
QNP50XY-250	250 μm x 250 μm closed-loop travel
QNP60XY-500	500 μm x 500 μm closed-loop travel
Feedback (Optional)	
-C	Capacitance sensor feedback
Mounting Plate (Optional)	
-MP	Mounting plate for English and metric optical breadboard tables
Adapter Plate (Ordered as a Separate Line Item)	
AP-QNP250XY-100Z	Adapter plate, lower: QNP250XY; upper: QNP100Z
AP-QNP500XY-100Z-250Z	Adapter plate, lower: QNP500XY; upper: QNP100Z / 250Z

1.1. Understanding Basic QNPXY Stage Operation

QNPXY stages have many operating characteristics that are unique to piezo actuator based systems. This section describes some of the unique aspects of QNPXY stages. It is strongly recommended that all QNPXY stage users read the “[Appendix C: Piezo Engineering Tutorial](#)” (or at www.aerotech.com) for more detailed information on operation principles and nomenclature.

Expansion Device

The piezo actuator in each QNPXY stage is an expansion device that expands proportionately with applied voltage. This has some practical implications for stage use. When de-energized (0 V), the actuator will compress and the stage will sit at one end of travel. When energized with positive voltage the actuator will expand and the stage will move toward the opposite end of travel. When energized with negative voltage the actuator will shrink and the stage will move further away from the center relative to the de-energized position. Each QNPXY stage is marked with arrows that indicate the direction of expansion (i.e. the positive voltage direction). [Figure 1-1](#) illustrates the relationship between voltage and position for a QNP single axis linear stage. This is representative of all Aerotech piezo stages.

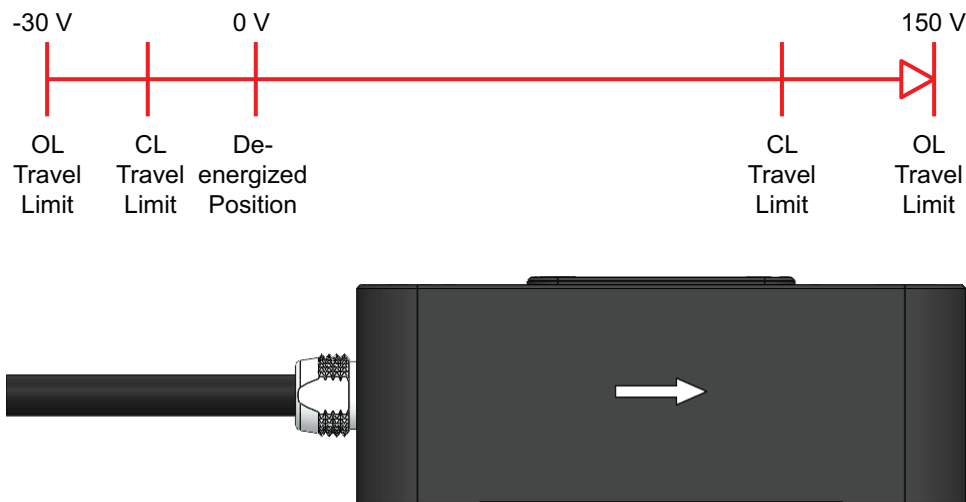

Figure 1-1: Single-Axis Stage Travel and Voltage Relationship

Open-Loop vs Closed-Loop Travel

All QNPXY stages with feedback (-C option) have an open-loop (OL) and closed-loop (CL) travel range (refer to [Section 1.4](#)). This refers to whether the stage is using feedback control (CL) or not (OL). QNPXY stages purchased without feedback have an open-loop travel range only. The open-loop range is the travel that can be achieved over the entire -30 to 150 V operation range. When the stage is in closed-loop (servo on), it requires over-travel to account for a variety of operational conditions, so the closed-loop range is smaller. Refer to [Figure 1-1](#) for an illustration of QNPXY stage travel ranges. QNPXY stages with the -C option are calibrated at the factory for optimal linearity over the specified closed-loop range only.

Unless otherwise specified, QNPXY stages configured at Aerotech default to open-loop operation and must be commanded to enter closed-loop mode. By default, all open-loop motion commands control voltage and all closed-loop motion commands control position. Refer to controller documentation for information on how to turn the servo on and off and adjust default settings.

1.2. Environmental Specifications



WARNING: Do not expose this product to environments or conditions outside of the listed specifications. Exceeding environmental or operating specifications can cause damage to the equipment.

The QNPXY stages are true nanopositioners. To achieve superior performance at the nanometer level, a very well controlled environment is essential. [Table 1-2](#) describes the minimally acceptable environmental specifications for normal stage operation. Better control of the environment will yield better system performance. Contact Aerotech for more information regarding your specific application and environment.

Humid environments are more detrimental to piezo actuators when they are held at high voltages for long periods of time. For static positioning applications it is recommended that QNPXY stages be configured to keep average voltage as low as possible to achieve maximum lifetime from the internal piezo actuator.

Operation in gaseous environments other than air may affect the rated operating voltage of the QNPXY stage. Consult the factory for details.



WARNING: Using the QNPXY in environments with relative humidity greater than 60% may require a reduction in travel and max voltage to ensure a long operating life.

Table 1-2: Minimum Acceptable Environmental Specifications

Ambient Temperature	The optimal operating temperature is 20° C ±2° C (68° F ±4° F). If at any time the operating temperature deviates from 20° C degradation in performance could occur.
	Storage: 0° to 40° C (32° to 104° F) in original shipping packaging
Humidity	Operating: <60% RH
	Storage: <40% RH, non-condensing in original packaging. The stage should be packaged with desiccant if it is to be stored for an extended time.
Altitude	Operating: 0 m to 2,000 m (0 ft to 6,562 ft) above sea level
Vibration	Floor or acoustic vibration will affect system performance. A quiet environment, isolated from ground vibration is recommended for optimum performance.
Protection Rating	The QNPXY stage is designed to operate in laboratories and clean production environments. Operation in heavy dust environments could lead to contamination inside the stage and degrade performance.
Use	Indoor use only

1.3. Linearity and Temperature Effects

Linearity is measured and calibrated for every QNPXY stage purchased with the -C feedback configuration. Unless otherwise specified, it is measured 15 mm above the center of the tabletop with the stage mounted in a standard horizontal position. The surface that the stage is mounted to must meet or exceed the requirements in [Section 2.3](#) to maintain the linearity measured at the factory.

Aerotech products are designed for and built in a 20°C (68°F) environment. Extreme temperature changes could cause a decrease in performance or permanent damage to the QNPXY. At a minimum, the environmental temperature must be controlled to within 0.25°C per 24 hours to ensure the QNPXY specifications are repeatable over an extended period of time. The smaller the variation in the ambient environment, the more stable the system will be. The severity of temperature effects on all specifications depends on many different environmental conditions, including how the QNPXY is mounted. Contact the factory for more details.

NOTE: QNPXY stages with feedback are paired with their drives and extension cables, if purchased, at the factory. If a stage with feedback is operated with different drives, amplifier slots, or extension cable lengths than it was initially paired with, the QNPXY may not maintain its specified linearity. New drive and stage combinations can be re-qualified at Aerotech to maintain optimum performance.

1.4. Basic Specifications

NOTE: Aerotech continually improves its product offerings; listed options may be superseded at any time. All drawings and illustrations are for reference only and were complete and accurate as of this manual's release. Refer to www.aerotech.com for the most up-to-date information.

Table 1-3: QNPXY Series Specifications

Specification ⁽¹⁾		QNP40XY-100	QNP50XY-250	QNP60XY-500
Closed-Loop Travel		100 μm	250 μm	500 μm
Open-Loop Travel, -30 to +150 V ⁽²⁾		120 μm	300 μm	600 μm
Resolution ⁽³⁾	Closed-Loop	0.30 nm	0.50 nm	0.90 nm
	Open-Loop	0.15 nm	0.20 nm	0.40 nm
Linearity ^(4, 5)		0.01%	0.01%	0.007%
Bidirectional Repeatability ⁽⁶⁾		2 nm	2 nm	5 nm
Pitch/Yaw		6 μrad (1.2 arc sec)	6 μrad (1.2 arc sec)	12 μrad (2.5 arc sec)
Stiffness (direction of motion) ⁽⁷⁾		1.05 N/ μm	0.36 N/ μm	0.24 N/ μm
Unloaded Resonance of Frequency ⁽⁷⁾	Top Axis	885 Hz	445 Hz	315 Hz
	Bottom Axis	635 Hz	295 Hz	200 Hz
Resonant Frequency (50 gram load) ⁽⁷⁾	Top Axis	495 Hz	305 Hz	240 Hz
	Bottom Axis	335 Hz	240 Hz	170 Hz
Maximum Acceleration (Unloaded) ⁽⁸⁾	Top Axis	600 m/s^2	370 m/s^2	210 m/s^2
	Bottom Axis	320 m/s^2	160 m/s^2	90 m/s^2
Moving Mass (Unloaded)	Top Axis	42 g	56 g	98 g
	Bottom Axis	79 g	126 g	217 g
Maximum Payload ⁽⁹⁾		1 kg	1 kg	1 kg
Stage Mass		0.11 kg	0.17 kg	0.27 kg
Material		Anodized Aluminum ⁽¹⁰⁾		
Mean Time Between Failure		30,000 Hours		
<p>1. Specifications are measured centered and at a height of approximately 15 mm above the output carriage.</p> <p>2. Value $\pm 10\%$</p> <p>3. Refer to Section C.4.2 Resolution for a description of resolution.</p> <p>4. Certified with each stage (closed-loop feedback models only).</p> <p>5. Refer to Section C.4.1 Accuracy/Linearity for description of linearity specifications.</p> <p>6. Specified as a 1 sigma (standard deviation) value. Refer to Section C.4.3 Repeatability for description of bidirectional repeatability.</p> <p>7. Value $\pm 20\%$</p> <p>8. Refer to Section C.4.6 Load Ratings for description of piezo stage load ratings</p> <p>9. On-axis loading is listed.</p> <p>10. External elements are anodized aluminum. Some internal components are stainless steel. Other materials upon request.</p>				

1.5. Vacuum Operation

Standard QNPXY stages are not designed to minimize outgassing in a vacuum environment. Aerotech can specially prepare any of the QNPXY stages for a wide range of vacuum environments. When using a QNPXY stage that has been specially prepared for vacuum environments several additional precautions must be taken to ensure proper operation.

1. The stage will be specially cleaned and sealed in a polyethylene bag at the factory. Do not remove the stage from this bag until it is ready for use.
2. Only handle the stage in a clean environment using powder-free polyethylene gloves to prevent contamination with oils and debris.
3. Use cleaned, vented, stainless steel fasteners when securing and mounting to the stage.
4. Piezo actuators cannot be operated at pressures from 10 to 10^{-2} Torr. The resistance of air dramatically reduces in this range and voltage may arc across the piezo actuator and destroy it. Remove power from the stage and disconnect it from its drive electronics during vacuum pump down operations to protect it from damage.
5. Baking components at elevated temperatures before installation in a vacuum chamber can greatly reduce initial outgassing from water vapor trapped in porous surfaces. QNPXY stages contain some heat sensitive components. Bake out temperatures should not exceed 100° C to prevent damage. If higher baking temperatures are required contact Aerotech to discuss the application. After bake out and vacuum chamber pump down, the piezo actuator should be repoled, as described in [Section 4.3.](#), before beginning normal operation.

Chapter 2: Mechanical Specifications and Installation



WARNING: QNPXY installation must be in accordance to instructions provided by this manual and any accompanying documentation. Failure to follow these instructions could result in injury or damage to the equipment.

2.1. Unpacking and Handling the Stage

NOTE: If any damage has occurred during shipping, report it immediately.



WARNING: It is the customer's responsibility to safely and carefully lift the stage. Improper handling could adversely affect the QNPXY stage's performance.

- Lift only by the base.
- Do not use the tabletop or cable as lifting points.



WARNING: An unsecured QNPXY stage could be dragged off of a mounting surface by its unsupported cable.

Carefully remove the QNPXY stage from its protective shipping container. Gently set the QNPXY stage on a smooth, flat, and clean surface.

Before operating the QNPXY stage, it is important to let it stabilize at room temperature for at least 12 hours. Allowing it to stabilize to room temperature will ensure that all of the alignments, preloads, and tolerances are the same as they were when tested at Aerotech. Use compressed nitrogen or clean, dry, oil-less air to remove any dust or debris that has collected during shipping.

Each QNPXY has a label listing the model number and system serial number. The label is located on the D-connector of each unit. These numbers contain information necessary for maintaining or updating system hardware and software. Locate this label and record the information for later reference. If any damage has occurred during shipping, report it immediately.

2.2. Dimensions

NOTE: Aerotech continually improves its product offerings; listed options may be superseded at any time. All drawings and illustrations are for reference only and were complete and accurate as of this manual's release. Refer to www.aerotech.com for the most up-to-date information.

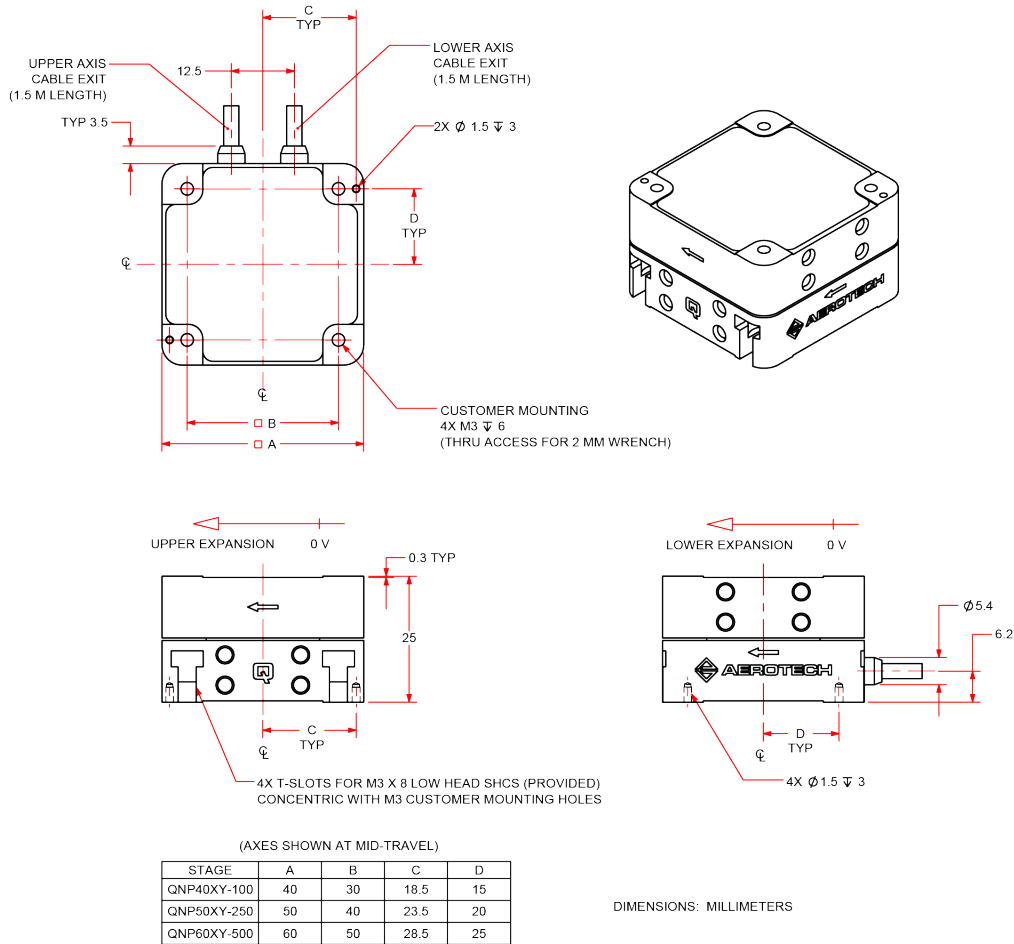

Figure 2-1: Dimensions

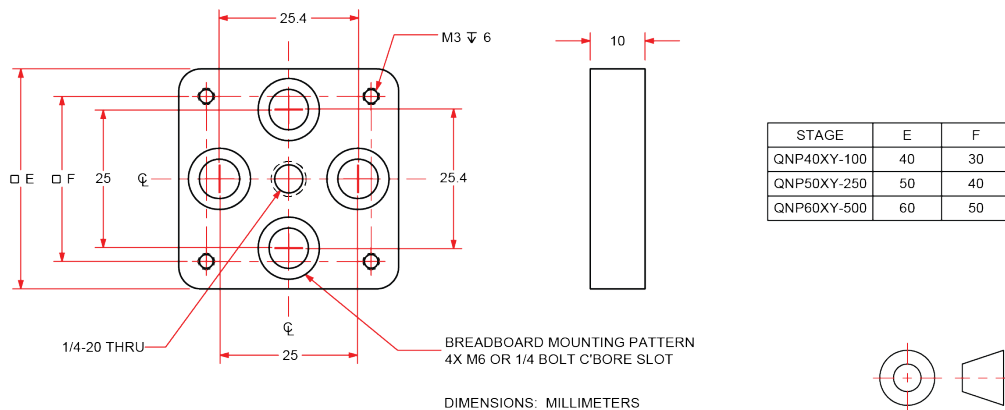

Figure 2-2: Mounting Plate (-MP) Dimensions

2.3. Securing the Stage to the Mounting Surface



WARNING: The QNPXY must be mounted securely. Improper mounting can result in injury and damage to the equipment.

The mounting surface must be flat and have adequate stiffness in order to achieve the maximum performance from the QNPXY stage. When it is mounted to a non-flat surface, the stage can be distorted as the mounting screws are tightened. This distortion will decrease overall linearity. Adjustments to the mounting surface must be done before the stage is secured.

Inspect the mounting surface for dirt or unwanted residue and clean if necessary. Use precision flatstones on the mounting surface to remove any burrs or high spots. Clean the mounting surface with a lint free cloth and acetone or isopropyl alcohol and allow the cleaning solvent to completely dry. Gently place the stage on the mounting surface.

NOTE: To maintain linearity, the mounting surface must be flat to within 5 μm .

NOTE: The QNPXY is precision machined and verified for flatness prior to product assembly at the factory. If machining is required to achieve the desired flatness, it should be performed on the mounting surface rather than the QNPXY. Shimming should be avoided if possible. If shimming is required, it should be minimized to retain maximum rigidity of the system.

QNPXY series stages have a fixed mounting pattern as shown in [Figure 2-3](#) and [Section 2.2](#). The M3 low-head mounting screws and 2 mm hex wrench required to mount the stage are included in the shipping box. To mount the QNPXY, insert the low-head screws through the T-slots on the side of the stage, then insert the wrench through the payload mounting holes on top of the stage to tighten the screws. This must be done before the payload is attached to the stage.

Tightening torque values for the mounting hardware are dependent on the properties of the surface to which the stage is being mounted. Values provided in [Table 2-1](#) are typical values and may not be accurate for your mounting surface. Refer to [Section 2.2](#) for specific model mounting locations and dimensions.

Table 2-1: Stage to Mounting Surface Hardware

Mounting Hardware	Typical Screw Torque
M3 by 8 mm [#5 by 5/8 in] Low Head SHCS	1 N·m
Ø1.5 x 3 mm deep pin holes (slip fit)	N/A

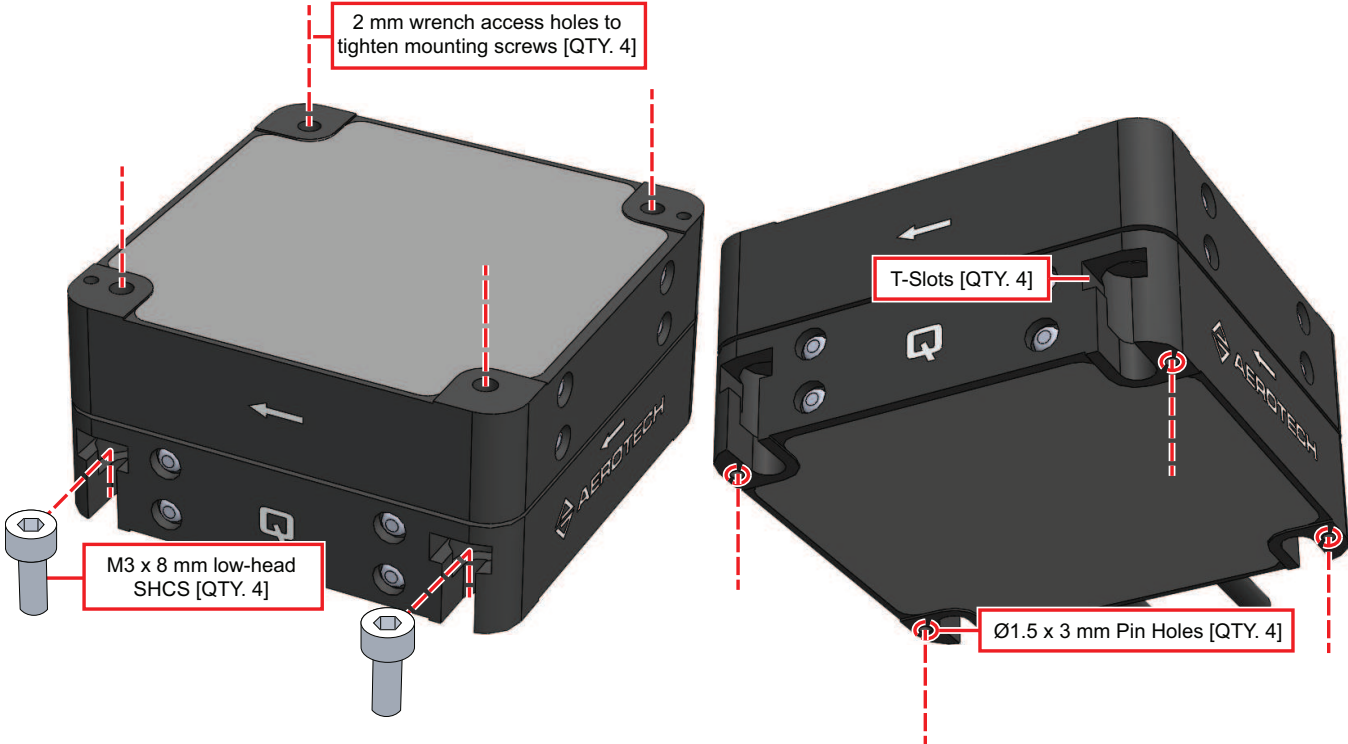

Figure 2-3: Mounting Hole Locations

2.4. Attaching the Payload to the Stage

To prevent damage to the payload or stage, test the operation of the stage before the payload is attached. Aerotech recommends that customers use a representative payload during start-up to prevent accidental damage to the stage and the payload. Proceed with the electrical installation and test the motion control system in accordance with the system documentation. Document all results for future reference. For information on electrical installation refer to [Chapter 3](#) and the documentation delivered with the stage.

NOTE: Standard QNPXY stages ship from the factory with no-load parameters (so that the stage will be stable if it is started up with no payload). How to tune your stage with a payload is described in the Quick Start guide supplied with your Aerotech piezo controller.

QNPXY stages are very sensitive to variations in payload when under servo control because of their compact, lightweight design. It is strongly recommended that stages with feedback be enabled with the servo off and adjusted according to the “Configuring the Servo Loop for a Piezo Stage” page in the Aerotech controller help documentation for all new payload configurations (this includes the no load configuration).

The payload must be flat, rigid, and comparable to the stage in quality to maintain optimum performance.

NOTE: For valid system performance, the mounting interface should be flat within 5 μm .

If a QNPXY stage with feedback is mounted in a vertical orientation with a heavy payload, its physical travel range may shift slightly relative to its feedback range. If this shift is observed, adjust the Absolute Feedback Offset in software as described in the Aerotech controller documentation.

You should take care to avoid damaging the QNPXY with dynamic forces. The Maximum Acceleration and Moving Mass specifications listed in [Table 1-3](#) can be used to determine the maximum safe acceleration for a given load condition. To do this, first calculate the maximum load in the direction of motion, also known as the push/pull force, using Newton’s second law as shown in [Equation 2-1](#).

$$F_{max} = m_{moving} \cdot a_{max,unloaded}$$

Equation 2-1

Then use this load to determine the maximum loaded acceleration as shown in [Equation 2-2](#).

$$a_{max,loaded} = \frac{F_{max}}{(m_{moving} + m_{load})}$$

Equation 2-2

The derived [Equation 2-3](#) can also be used to directly calculate the maximum loaded acceleration.

$$a_{max,loaded} = \frac{m_{moving}}{(m_{moving} + m_{load})} \cdot a_{max,unloaded}$$

Equation 2-3

NOTE: For most applications, the maximum allowable acceleration is not the optimal acceleration. Piezo stages are lightly damped and large accelerations will cause excessive position error with minimal change in move times. Aerotech recommends determining the optimal acceleration for a given move experimentally with the help of advanced tools included with the Aerotech controller, such as the Digital Scope. Refer to controller documentation or contact Aerotech for more information.

Table 2-2: Customer Mounting Features

Mounting Hardware	Quantity
M3x0.5, 6 mm deep, threaded holes	4 Places
Ø1.5 x 3 mm deep pin holes (slip fit)	2 Places



WARNING: Refer to the dimensions in [Section 2.2](#). for maximum allowable thread engagement. A screw extending through the stage table can affect travel and damage the stage.

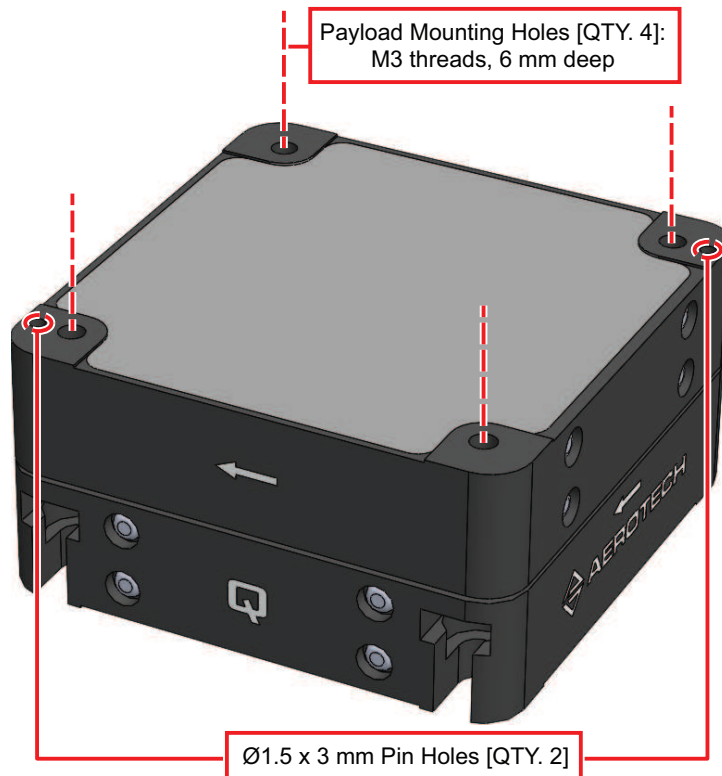
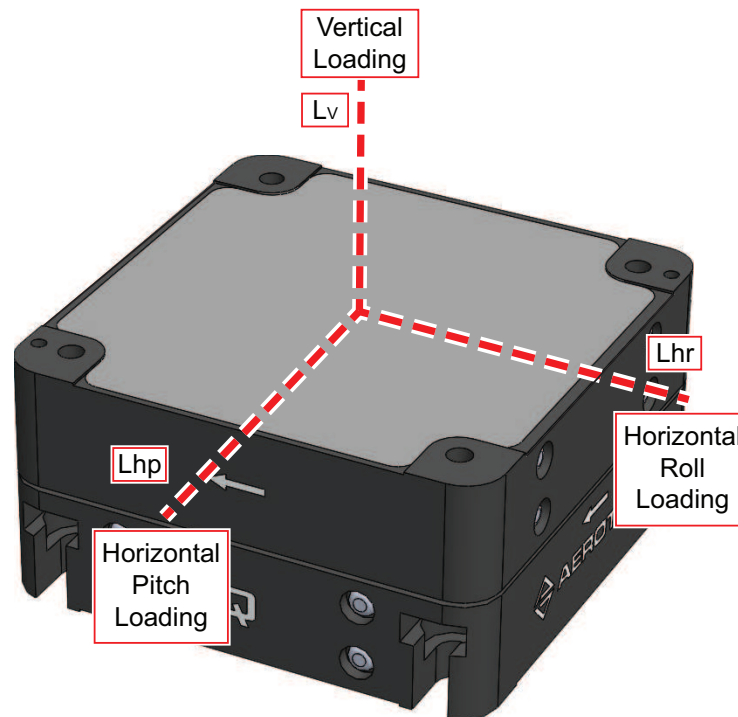

Figure 2-4: Mounting Hole Locations (Tabletop)

2.5. Load Capability

QNPXY stages are tested and specified with symmetrically distributed loads (i.e. center of mass in the center of the Tabletop with the stage mounted horizontally). The stages can operate effectively under a variety of loading conditions as described in this section. However, the addition of a moment load due to vertical mounting or an offset payload can add unpredictable strain to the flexure bearing. This can degrade system performance. Refer to [Section 1.4](#) for maximum load carrying capacity specifications. Contact Aerotech to discuss how your load condition may affect the performance of your QNPXY stage.

[Figure 2-5](#) shows three principal directions a load can be offset from the center of the QNPXY stage Tabletop and the corresponding loading condition. The plots that follow estimate the 1st natural frequency of the QNPXY stage for various axis offset and load combinations in each of these three directions. When the stage is under servo control, the highest controllable operational frequency (the bandwidth) will be 1/3 to 1/5 of the natural frequency shown. These plots are meant to serve as a starting point for making operational decisions about the QNPXY stage. Testing the QNPXY with your specific payload is necessary for more precise values.



Load conditions apply regardless of orientation to gravity.

Figure 2-5: Offset Load Principal Directions

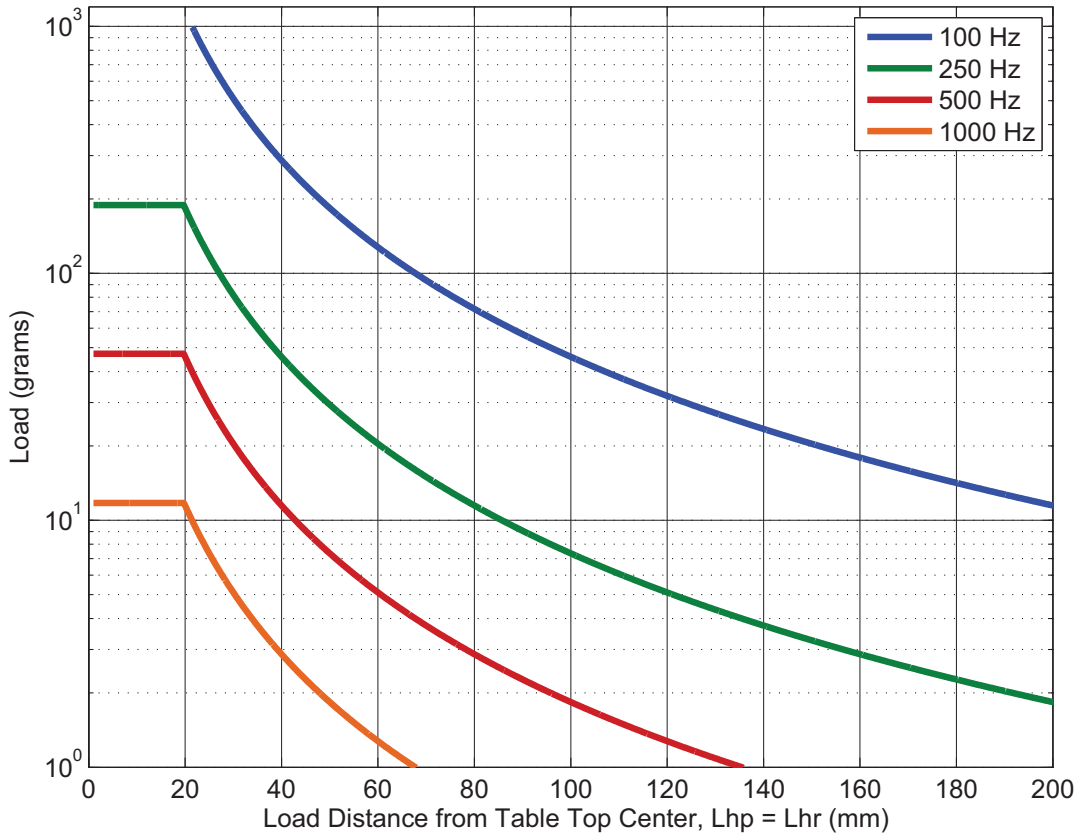

Figure 2-6: QNP40XY-100, 1st Natural Frequencies for Point Load Offset from Tabletop Center in Horizontal Direction (HR and HP)

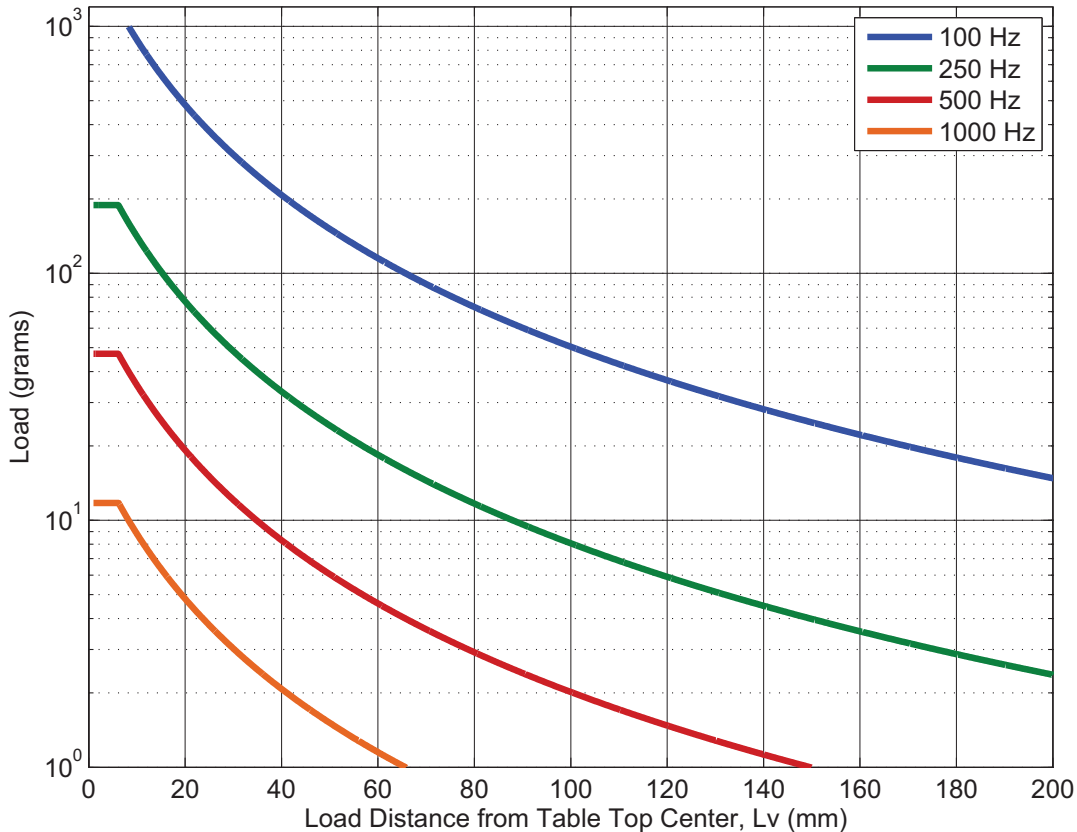

Figure 2-7: QNP40XY-100, 1st Natural Frequencies for Point Load Offset from Tabletop Center in Vertical Direction

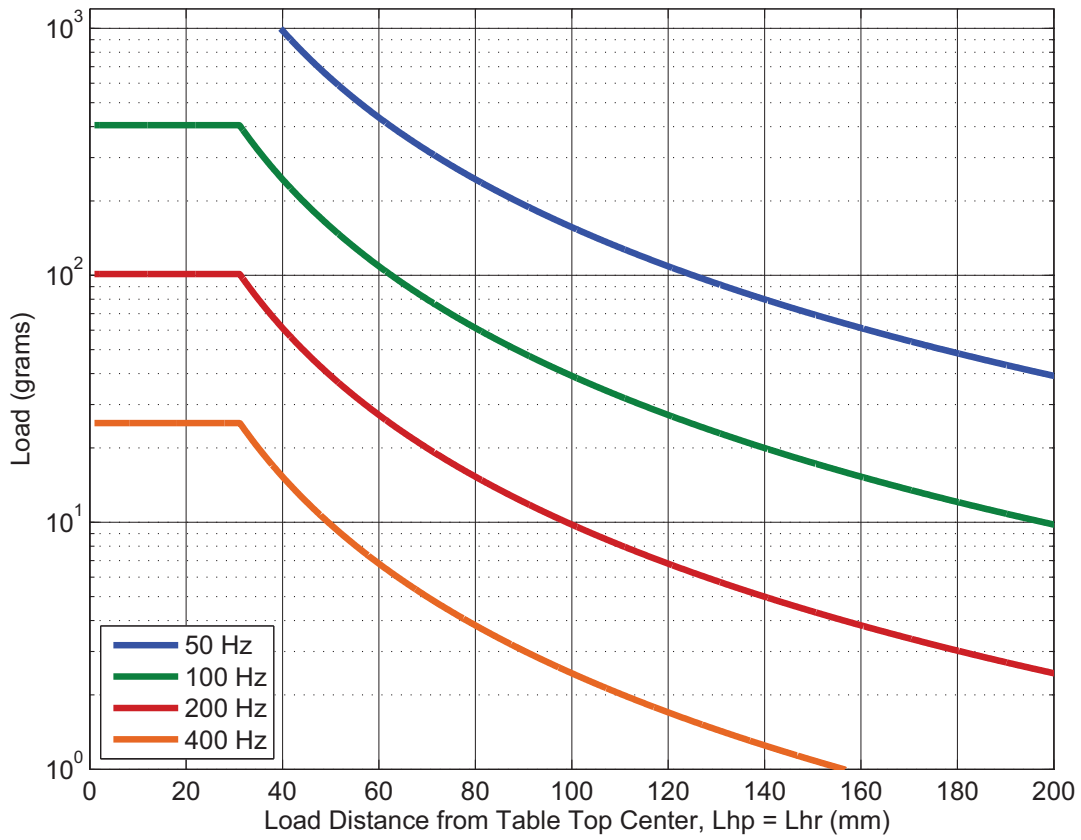

Figure 2-8: QNP50XY-250, 1st Natural Frequencies for Point Load Offset from Tabletop Center in Horizontal Direction (HR and HP)

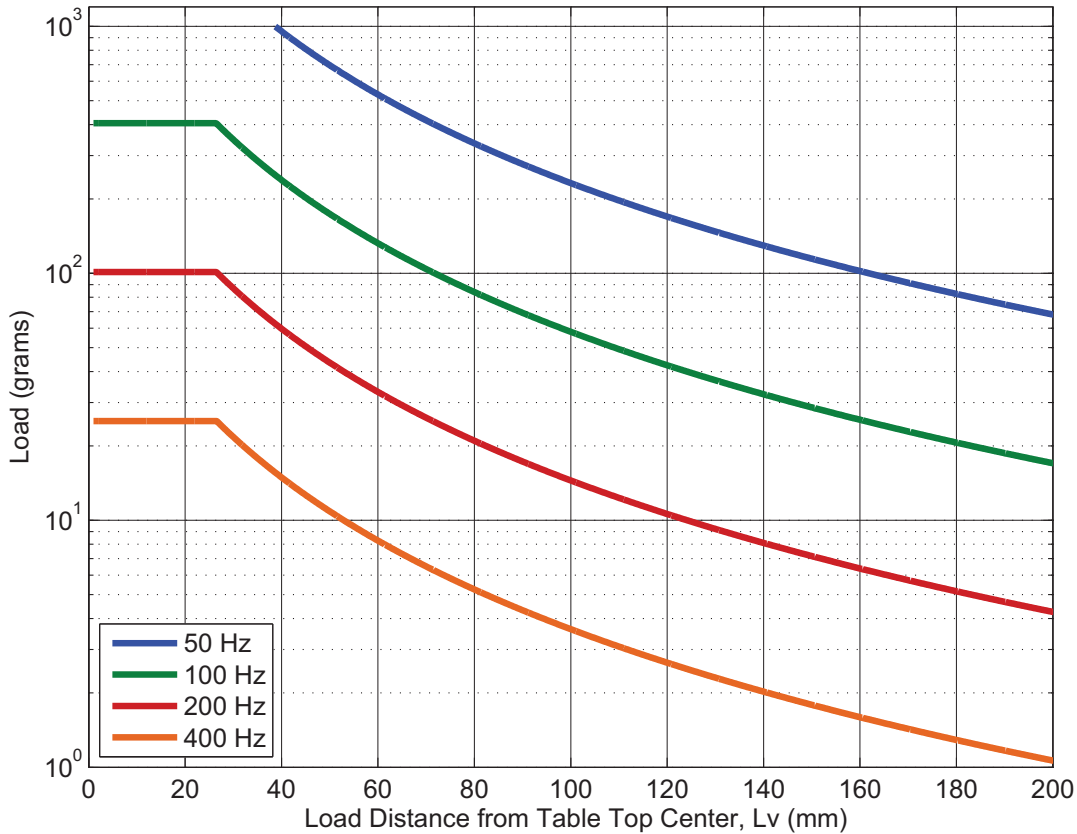

Figure 2-9: QNP50XY-250, 1st Natural Frequencies for Point Load Offset from Tabletop Center in Vertical Direction

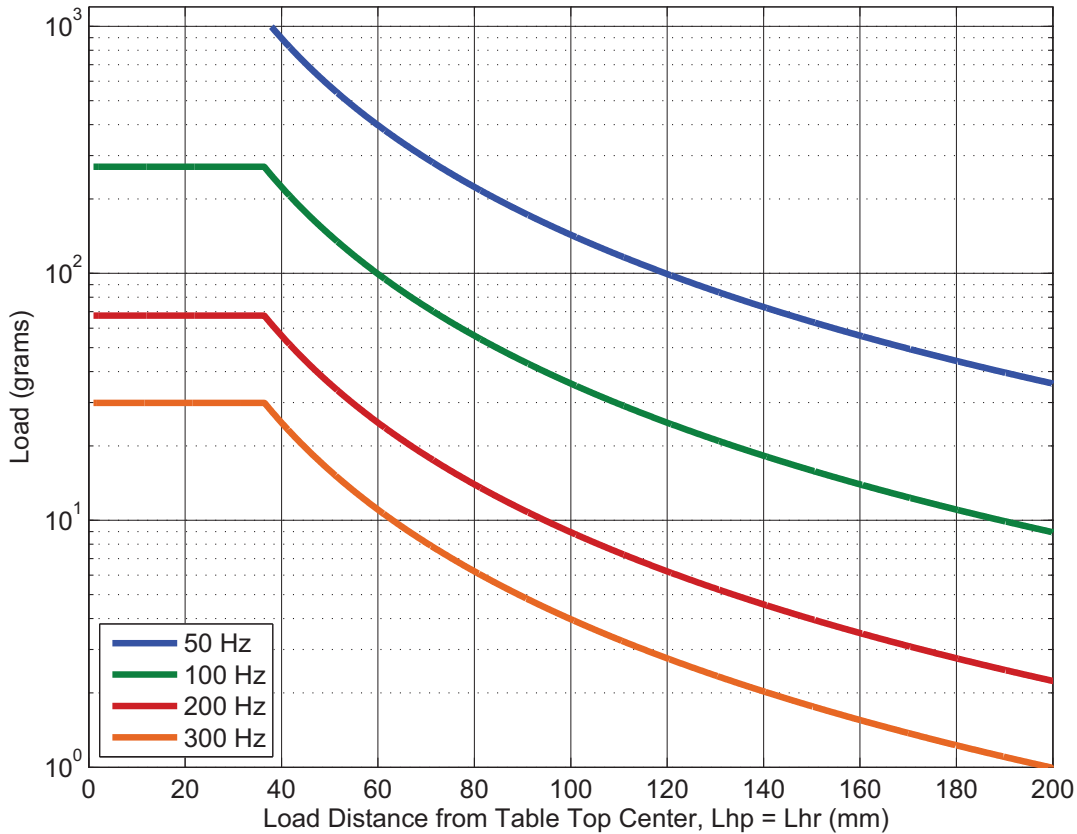

Figure 2-10: QNP60XY-500, 1st Natural Frequencies for Point Load Offset from Tabletop Center in Horizontal Direction (HR and HP)

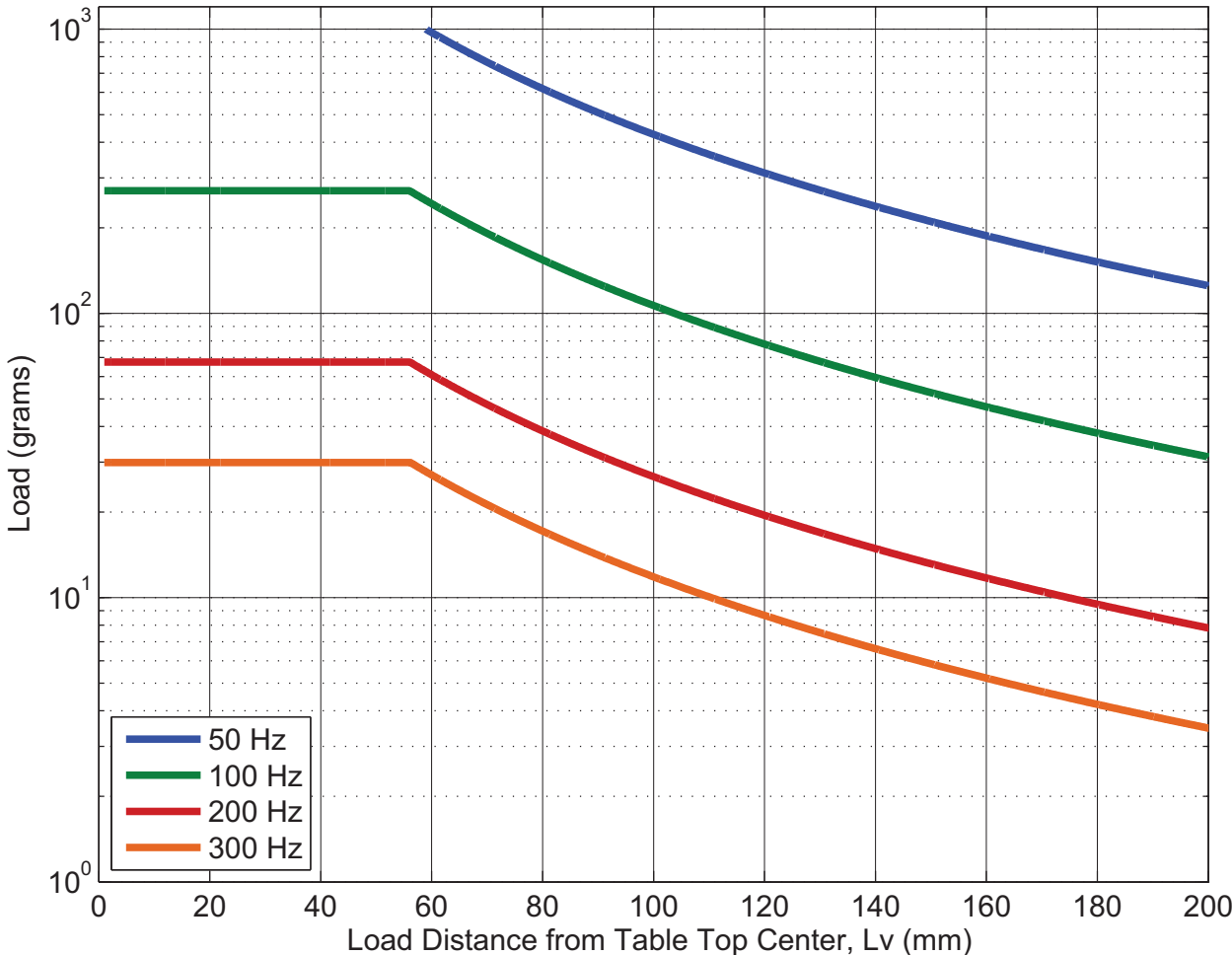

Figure 2-11: QNP60XY-500, 1st Natural Frequencies for Point Load Offset from Tabletop Center in Vertical Direction

2.6. Cable Bend Radius

The minimum static bend radius for a QNPXY main cable is 4 mm. Aerotech recommends that the cable not be used dynamically because it may affect linearity performance. If the piezo cable needs to pass through a dynamic cable chain, Aerotech recommends that the piezo stage cable be terminated before the cable chain and connected to an extension cable that routes through the cable chain. If this is not possible, contact an Aerotech representative to discuss your options.

Chapter 3: Electrical Specifications and Installation



WARNING: Electrical installation must be performed by properly qualified personnel.

Aerotech motion control systems are adjusted at the factory for optimum performance. When the QNPXY is part of a complete Aerotech motion control system, setup usually involves connecting a stage to the appropriate drive chassis with the cables provided. Labels on the system components usually indicate the appropriate connections.

If system level integration was purchased along with the stage, an electrical drawing showing system interconnects has been supplied with the system (separate from this documentation).

The electrical wiring from the piezo stage and optional feedback device are integrated at the factory. Refer to the following sections for standard wiring and connector pin assignments.



WARNING: Operator access to the base and tabletop must be restricted while connected to a power source. Failure to do so may cause electric shock.



DANGER: Remove power before connecting or disconnecting electrical components or cables. Failure to do so may cause electric shock.



WARNING: Applications requiring access to the stage while it is energized will require additional grounding and safeguards. The System Integrator or qualified installer is responsible for determining and meeting all safety and compliance requirements necessary for the integration of this stage into the final application.

3.1. Piezo Connectors

NOTE: Refer to the other documentation accompanying your Aerotech equipment. Call your Aerotech representative if there are any questions on system configuration.

The protective ground connection of the QNPXY grounds the entire stage frame to the common ground on the stage connector. The coating on the stage is not electrically conductive. Additional grounding and safety measures are required for applications requiring access to the stage while it is energized. The System Integrator or qualified installer is responsible for determining and meeting all safety and compliance requirements necessary for the integration of this stage into the final application.



DANGER: Remove power before connecting or disconnecting electrical components or cables. Failure to do so may cause electric shock.



WARNING: Operator access to the base and tabletop must be restricted while connected to a power source. Failure to do so may cause electric shock.



CAUTION: The stage controller must provide voltage range and over-speed protection. Failure to do so may result in permanent damage to the actuator and stage components.

Table 3-1: Piezo Connector Pin Description

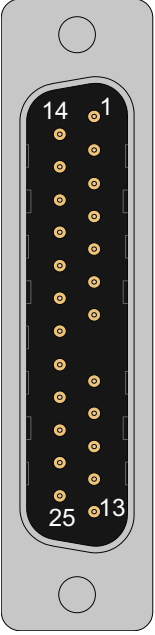
Pin	Description	Connector
CASE	Outer Shield	
8	Connector key (to prevent improper connection)	
12	Frame ground for piezo stage	
13	Piezo Actuator High Voltage Input +	
25	Piezo Actuator Return -	
1	Reserved	
2	Reserved	
3	Reserved	
4	Reserved	
5	Reserved	
6	Reserved	
7	Reserved	
9	Reserved	
10	Reserved	
11	Reserved	
14	Reserved	
15	Reserved	
16	Reserved	
17	Reserved	
18	Reserved	
19	Reserved	
20	Reserved	
21	Reserved	
22	Reserved	
23	Reserved	
24	Reserved	

Mating Connector	Aerotech P/N	Third Party P/N
Backshell	ECK01057	AMP 745173-4
Connector	ECK00300	FCI DB25S064TLF

3.2. Piezo Wiring

Shielded cables are required for the piezo actuator connections.

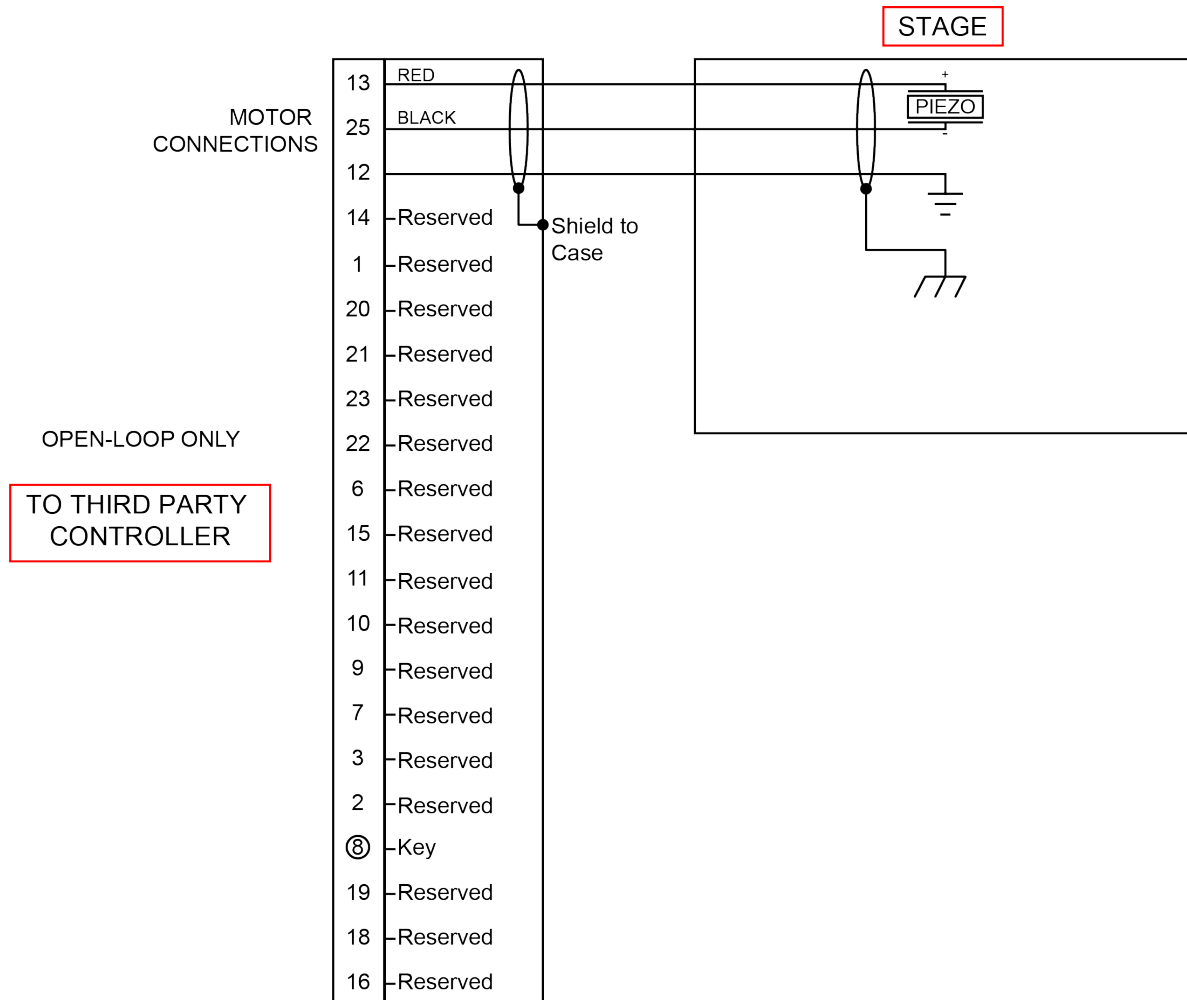

Figure 3-1: Piezo Actuator Wiring

3.3. Electrical Specifications

NOTE: Aerotech continually improves its product offerings; listed options may be superseded at any time. All drawings and illustrations are for reference only and were complete and accurate as of this manual's release. Refer to www.aerotech.com for the most up-to-date information.

Table 3-2: Electrical Specifications

	QNP40XY-100	QNP50XY-250	QNP60XY-500
Drive System	Piezo multi-layer stack actuator		
Feedback	Closed-Loop: Capacitive Sensor (-C) Open-Loop: None (-)		
Piezo Stack Voltage Range	-30 V to +150 V		
Piezo Stack Max Current	500 mA		
Piezo Stack Capacitance ⁽¹⁾	1.6 μ F	2.3 μ F	6.4 μ F
Amplifier Requirements	115-230 VAC Nominal AC input, Double insulated transformer with grounded secondary. Amplifier output to Piezo fused at .5 A.		
Loss Factor ($\tan \delta$) ⁽²⁾	0.02		
1. Value \pm 20%			
2. Value for low-amplitude excitation			



WARNING: Do not exceed the voltage range in [Table 3-2](#) when driving the QNPXY stage or permanent damage may result.

3.4. Machine Direction

Aerotech stages are configured to have positive and negative "machine" directions. The machine direction defines the phasing of the feedback and piezo signals and is dictated by the stage wiring. Programming direction of a stage is set by the controller that is used to move the stage. Programming direction is typically selectable in the controller, while machine direction is hardwired in the stage. [Figure 3-2](#) shows the machine direction of the upper and lower axes of QNPXY stages.

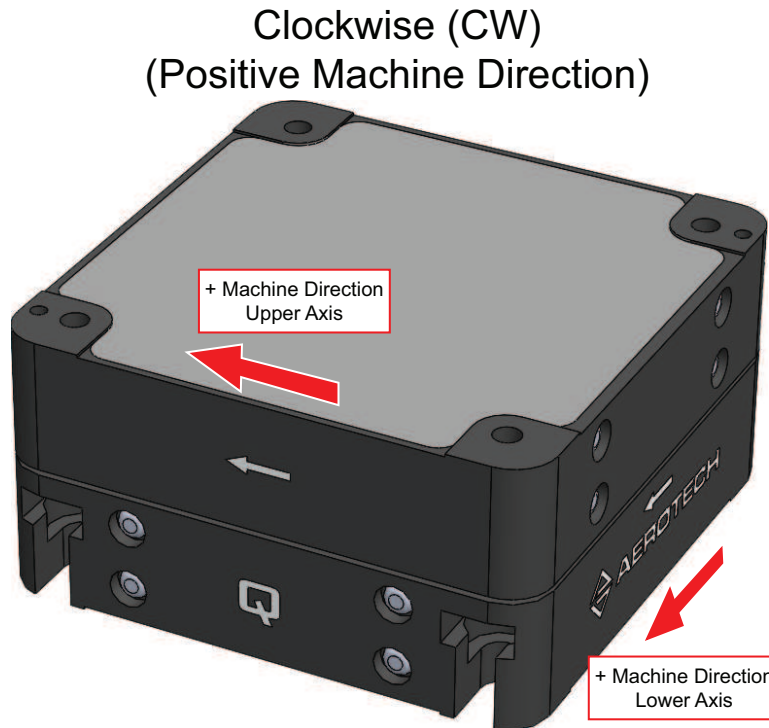

Figure 3-2: Machine Direction

3.5. Travel Limits

All QNPXY stages purchased with capacitance feedback (-C option) and configured with an Aerotech drive will have two sets of travel limits: Software Limits and End-of-Travel limits. Stages purchased without feedback will not have travel limits.

Software Limits

Software limits protect the user from driving or commanding the QNPXY stage outside of the specified closed-loop travel range. The standard location for software limits on a QNPXY stage is one micron past each end of closed-loop travel. They are only active when the stage is in closed-loop mode (SERVO ON). When the stage enters a limit, the controller will stop motion and return a limit fault. Refer to Aerotech controller documentation for more information on software limits.

End-of-Travel Limits

End-of-travel limits are placed outside of the software limits at the extents of the sensor range. They are a fail-safe measure used to prevent the stage from losing feedback. The operation of the end-of-travel limits is very similar to software limits. The CCW End-Of-Travel limit in the direction of travel that corresponds to negative voltage (refer to [Section 1.1.](#)) is active in closed-loop mode (SERVO ON) only. The controller will stop motion and return a fault when the CCW End-Of-Travel limit is reached. The CW End-Of-Travel limit in the direction of travel that corresponds to positive voltage is always on. When the CW End-Of-Travel limit is reached the controller will disable the stage. This is necessary to protect the capacitance sensor.

NOTE: In open-loop mode (SERVO OFF), the position of a piezo stage will drift when the voltage is held constant. This may result in the piezo stage drifting into an End-Of-Travel limit over time when held at an extreme end of the voltage range.

NOTE: When subjected to high side loads, QNPXY stages with the -C option may experience slightly reduced open-loop range and may be more likely to encounter End-Of-Travel limits at the extreme ends of travel.

This page intentionally left blank.

Chapter 4: Maintenance

The QNPXY series stages are designed to require minimum maintenance. This chapter will detail the cleaning process and specify recommended cleaning solvents.

4.1. Service and Inspection Schedule



DANGER: To minimize the possibility of bodily injury or death, disconnect all electrical power prior to performing any maintenance or making adjustments to the equipment.

Inspect the QNPXY once per month. A longer or shorter inspection interval may be required depending on the specific application, and conditions such as the duty cycle, speed, and environment.

Visually inspect the stage and cables once per month to:

- Re-tighten loose mounting screws.
- Replace or repair damaged cables.
- Clean the QNPXY stage and any components and cables if needed.
- Assess any damage to the QNPXY stage .

In general, repair and/or replacement of damaged or malfunctioning components by Aerotech field service personnel is not possible. Repair typically requires that the unit be returned to the factory. Please contact Aerotech Technical Support for more information.

4.2. Cleaning and Lubrication



WARNING: In applications that have multiple stages bolted together to form multi-axis systems, the orthogonality may be lost if the stage tables of the support stages are loosened. Precision aligned stages should not be loosened or disassembled.



WARNING: Further disassembly of the stage is not recommended because proper assembly and calibration can only be done at the factory. In addition, a laser interferometer is required for post assembly verification to maintain warranties. Contact Aerotech for more information.

There are no elements on QNPXY stages that require lubrication.

Before using a cleaning solvent on any part of the QNPXY, blow away small particles and dust with nitrogen or, less preferably, clean, dry, compressed air.

Any metal surface on the stage can be cleaned with either acetone or isopropyl alcohol. Lightly spray the solvent on a non-abrasive wipe; then wipe the stage. Never spray the stage with solvent or allow solvent to pool on the surface. If liquid runs into the stage it can damage sensitive internal components.

4.3. Poling the Piezo Actuator

Piezo actuators undergo a process called “poling”, where they are subjected to a high electric field which creates a charge imbalance in their structure. This charge imbalance is what causes expansion in response to an applied voltage. If the QNPXY stage is subjected to elevated temperatures or left idle for a long period of time, the piezo actuator will gradually de-pole and return to a neutral state. If the QNPXY stage has been exposed to temperatures above 85° C or left idle for several weeks it can be easily re-poled to its fully functioning state using the following procedure:

1. Connect the stage to its drive electronics in accordance with the procedures in [Chapter 3](#).
2. Enable the stage in open-loop (servo off mode) at 0 V.
3. Drive the stage to 150 V. Hold for 10 seconds.
4. Drive the stage back to 0 V.
5. Resume normal operation.

4.4. Troubleshooting

Table 4-1: Troubleshooting

Symptom	Possible Cause and Solution
Stage will not move	<ul style="list-style-type: none"> Improper electrical connection. Check stage and drive connections. Controller trap or fault (refer to controller documentation).
Stage oscillates or squeals or gives a fault when the servo is turned on	<ul style="list-style-type: none"> Servo gains and filters improperly configured for payload. Switch to servo off mode and make adjustments based on controller documentation (refer to the online help “Configuring the Servo Loop for a Piezo Stage”). Improper controller parameters (refer to controller documentation)
Travel is reduced after exposure to high temperatures or a long idle period	<ul style="list-style-type: none"> Piezo actuator has lost polarization. Re-pole in accordance with Section 4.3.
Stage disables and/or faults at the end of open-loop travel	<ul style="list-style-type: none"> Stage is driving into End-Of-Travel limit because of a heavy load condition. Restrict the commanded voltage range or change the Voltage Clamps in the stage parameter file to avoid entering the limit. Alternately, changing the stage orientation may prevent it from entering the limit. Stage is driving into an End-Of-Travel limit because it is being held at a voltage extreme. Restrict the commanded voltage range or change the Voltage Clamps in the stage parameter file to avoid entering the limit.
Stage disables or faults inside normal closed-loop travel range	<ul style="list-style-type: none"> Stage travel has shifted because of a heavy load condition. Run the AbsoluteFeedbackOffset Calculator to center the stage in its working range. Travel limits are configured incorrectly in the controller. Consult Aerotech for proper limit settings.

This page intentionally left blank.

Appendix A: Warranty and Field Service

Aerotech, Inc. warrants its products to be free from harmful defects caused by faulty materials or poor workmanship for a minimum period of one year from date of shipment from Aerotech. Aerotech's liability is limited to replacing, repairing or issuing credit, at its option, for any products that are returned by the original purchaser during the warranty period. Aerotech makes no warranty that its products are fit for the use or purpose to which they may be put by the buyer, whether or not such use or purpose has been disclosed to Aerotech in specifications or drawings previously or subsequently provided, or whether or not Aerotech's products are specifically designed and/or manufactured for buyer's use or purpose. Aerotech's liability on any claim for loss or damage arising out of the sale, resale, or use of any of its products shall in no event exceed the selling price of the unit.

THE EXPRESS WARRANTY SET FORTH HEREIN IS IN LIEU OF AND EXCLUDES ALL OTHER WARRANTIES, EXPRESSED OR IMPLIED, BY OPERATION OF LAW OR OTHERWISE. IN NO EVENT SHALL AEROTECH BE LIABLE FOR CONSEQUENTIAL OR SPECIAL DAMAGES.

Return Products Procedure

Claims for shipment damage (evident or concealed) must be filed with the carrier by the buyer. Aerotech must be notified within thirty (30) days of shipment of incorrect material. No product may be returned, whether in warranty or out of warranty, without first obtaining approval from Aerotech. No credit will be given nor repairs made for products returned without such approval. A "Return Materials Authorization (RMA)" number must accompany any returned product(s). The RMA number may be obtained by calling an Aerotech service center or by submitting the appropriate request available on our website (www.aerotech.com). Products must be returned, prepaid, to an Aerotech service center (no C.O.D. or Collect Freight accepted). The status of any product returned later than thirty (30) days after the issuance of a return authorization number will be subject to review.

Visit <https://www.aerotech.com/global-technical-support.aspx> for the location of your nearest Aerotech Service center.

Returned Product Warranty Determination

After Aerotech's examination, warranty or out-of-warranty status will be determined. If upon Aerotech's examination a warranted defect exists, then the product(s) will be repaired at no charge and shipped, prepaid, back to the buyer. If the buyer desires an expedited method of return, the product(s) will be shipped collect. Warranty repairs do not extend the original warranty period.

Fixed Fee Repairs - Products having fixed-fee pricing will require a valid purchase order or credit card particulars before any service work can begin.

All Other Repairs - After Aerotech's evaluation, the buyer shall be notified of the repair cost. At such time the buyer must issue a valid purchase order to cover the cost of the repair and freight, or authorize the product(s) to be shipped back as is, at the buyer's expense. Failure to obtain a purchase order number or approval within thirty (30) days of notification will result in the product(s) being returned as is, at the buyer's expense.

Repair work is warranted for ninety (90) days from date of shipment. Replacement components are warranted for one year from date of shipment.

Rush Service

At times, the buyer may desire to expedite a repair. Regardless of warranty or out-of-warranty status, the buyer must issue a valid purchase order to cover the added rush service cost. Rush service is subject to Aerotech's approval.

On-site Warranty Repair

If an Aerotech product cannot be made functional by telephone assistance or by sending and having the customer install replacement parts, and cannot be returned to the Aerotech service center for repair, and if Aerotech determines the problem could be warranty-related, then the following policy applies:

Aerotech will provide an on-site Field Service Representative in a reasonable amount of time, provided that the customer issues a valid purchase order to Aerotech covering all transportation and subsistence costs. For warranty field repairs, the customer will not be charged for the cost of labor and material. If service is rendered at times other than normal work periods, then special rates apply.

If during the on-site repair it is determined the problem is not warranty related, then the terms and conditions stated in the following "On-Site Non-Warranty Repair" section apply.

On-site Non-Warranty Repair

If any Aerotech product cannot be made functional by telephone assistance or purchased replacement parts, and cannot be returned to the Aerotech service center for repair, then the following field service policy applies:

Aerotech will provide an on-site Field Service Representative in a reasonable amount of time, provided that the customer issues a valid purchase order to Aerotech covering all transportation and subsistence costs and the prevailing labor cost, including travel time, necessary to complete the repair.

Service Locations

<http://www.aerotech.com/contact-sales.aspx?mapState=showMap>

USA, CANADA, MEXICO Aerotech, Inc. Global Headquarters Phone: +1-412-967-6440 Fax: +1-412-967-6870	CHINA Aerotech China Full-Service Subsidiary Phone: +86 (21) 3319 7715	GERMANY Aerotech Germany Full-Service Subsidiary Phone: +49 (0)911 967 9370 Fax: +49 (0)911 967 93720
JAPAN Aerotech Japan Full-Service Subsidiary Phone: +81 (0)50 5830 6814 Fax: +81 (0)43 306 3773	TAIWAN Aerotech Taiwan Full-Service Subsidiary Phone: +886 (0)2 8751 6690	UNITED KINGDOM Aerotech United Kingdom Full-Service Subsidiary Phone: +44 (0)1256 855055 Fax: +44 (0)1256 855649

Have your customer order number ready before calling.

Appendix B: Revision History

Revision	General Information
1.02.00	Product update
1.01.00	Updates have been made to the following sections: <ul style="list-style-type: none">• Safety Procedures and Warnings• Section 1.3. Linearity and Temperature Effects• Section 1.4. Basic Specifications• Section 2.3. Securing the Stage to the Mounting Surface• Section 2.4. Attaching the Payload to the Stage• Section 3.1. Piezo Connectors• Section 3.2. Piezo Wiring• Section 3.3. Electrical Specifications
1.00.00	New manual

This page intentionally left blank.

Appendix C: Piezo Engineering Tutorial

C.1 The Direct and Inverse Piezoelectric Effect

In 1880, while performing experiments with tourmaline, quartz, topaz, cane sugar and Rochelle salt crystals, Pierre and Jacques Curie discovered that when mechanical stress was applied to a crystal, faint electric charges developed on the surface of that crystal. The prefix “piezo” comes from the Greek piezein, which means to squeeze or press. As a result, piezoelectricity is electrical charge that is produced on certain materials when that material is subjected to an applied mechanical stress or pressure. This is known as the *direct piezoelectric effect*.

The *converse* or *inverse piezoelectric effect*, or the application of an electric field to induce strain, was discovered using thermodynamic principles in 1881 by Gabriel Lippmann. It is the inverse piezoelectric effect that enables piezoelectric materials to be used in positioning applications.

C.2 Piezo Actuator Materials

Although many materials exhibit the inverse piezoelectric effect, the most popular and widely applicable piezoelectric material by far is PZT, or lead-zirconium-titanate. The term PZT is generally used to refer to a wide range of ceramics which display different properties depending on the grain size and mixture ratios of their main raw materials: lead, zirconium and titanium. The properties of the ceramic can also be manipulated by adding dopants and making adjustments to the manufacturing process. The recipes for particular materials are usually proprietary and vary between suppliers.

C.2.1 RoHS Exemption

Despite the presence of lead as a doping material, PZTs are exempt from RoHS directive 2002/95/EC due to a lack of a suitable replacement material. Although efforts are underway to develop alternative materials, no suitable alternative is expected in the field for years to come.

C.3 Properties of Piezo Actuators

C.3.1 Displacement Performance

The response of a piezoelectric material to an applied stress or applied electric field depends on the direction of application relative to the polarization direction. Because of this, most electrical and mechanical properties that describe piezo materials are direction dependent, as well.

The inverse piezoelectric effect can be described mathematically as:

$$\text{Equation 1} \quad X_j = d_{ij} \cdot E_i$$

where, X_j is strain (m/m), d_{ij} is the piezoelectric charge coefficient (m/V) and is a material property, and E_i is the applied electric field (V/m). The subscripts i and j represent the strain direction and applied electric field direction, respectively. Electric field is a voltage across a distance, so large electric fields can be generated with small voltages if the charge separation distance is very small.

As a general rule, the strain (X_j) for most PZT materials found on the market is around 0.1 to 0.15% for applied electric fields on the order of 2 kV/mm. For example, a 20 mm long active-length PZT actuator will generate approximately 20-30 μm of maximum displacement. One can easily see that to generate 250 μm , a PZT stack would be approximately 170 to 250 mm long. Therefore, most piezo flexure stages with >50 μm of travel use lever amplification to achieve longer travels in a more compact package size. A tradeoff is made

between the final device package size and stiffness because the stiffness of the device decreases with the square of the lever amplification ratio used. Aerotech's piezo nanopositioning stages are optimized to provide superior mechanical performance in a compact stage package.

C.3.2 Hysteresis Effects

Piezoelectric materials are a subset of a larger class of materials known as ferroelectrics. Ferroelectricity is a property of certain materials that have a spontaneous electric polarization that can be reversed by the application of an electric field. Like the magnetic equivalent (ferromagnetic materials), ferroelectric materials exhibit hysteresis loops based on the applied electric field and the history of that applied electric field. [Figure C-1](#) shows an illustration of a strain (X) versus electric field (E) "butterfly" curve for a PZT material driven to its excitation limits.

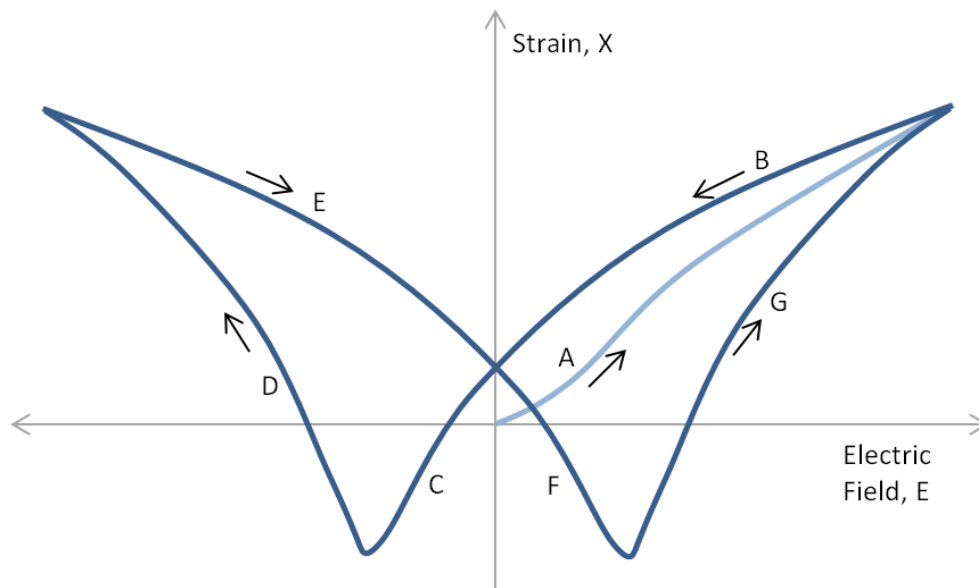

Figure C-1: Strain (displacement) behavior of a ferroelectric material like PZT with an applied electric field driven to its excitation limits

As the electric field is cycled from positive to negative to positive, the following transformations occur in the piezo actuator:

- A. Initially, strain increases with electric field and is only slightly nonlinear. As the electric field is increased, the dipoles of all the grains will eventually align to the electric field as optimally as is possible and the distortion of the grains will approach a physical limit.
- B. When the field is reversed, strain decreases more slowly due to the reoriented dipoles. As the field gets smaller, the dipoles relax into less ideal orientations and strain decreases at a faster rate.
- C. As the field becomes negative the dipoles are forced away from their original orientation. At a critical point they completely reverse direction and the piezo actuator becomes polarized in the opposite direction. The electric field at the point of polarization reversal is known as the coercive field (E_c).
- D. After polarization reversal, the piezo expands again until it reaches its physical strain limit.
- E. The electric field is reversed again and the same hysteretic behavior that occurred along curve B occurs as strain decreases.

- F. The electric field is driven to the coercive limit for the opposite polarization direction and the dipoles reorient to their original polarization.
- G. The piezo actuator expands with the applied electric field to its physical limit.

For positioning applications, piezo actuators are generally operated with a semi-bipolar voltage over an area of the curve (ABC) away from the saturation and coercive field limits. An example of displacement versus applied voltage for a piezo actuator stack in this region of the curve is shown in [Figure C-2](#).

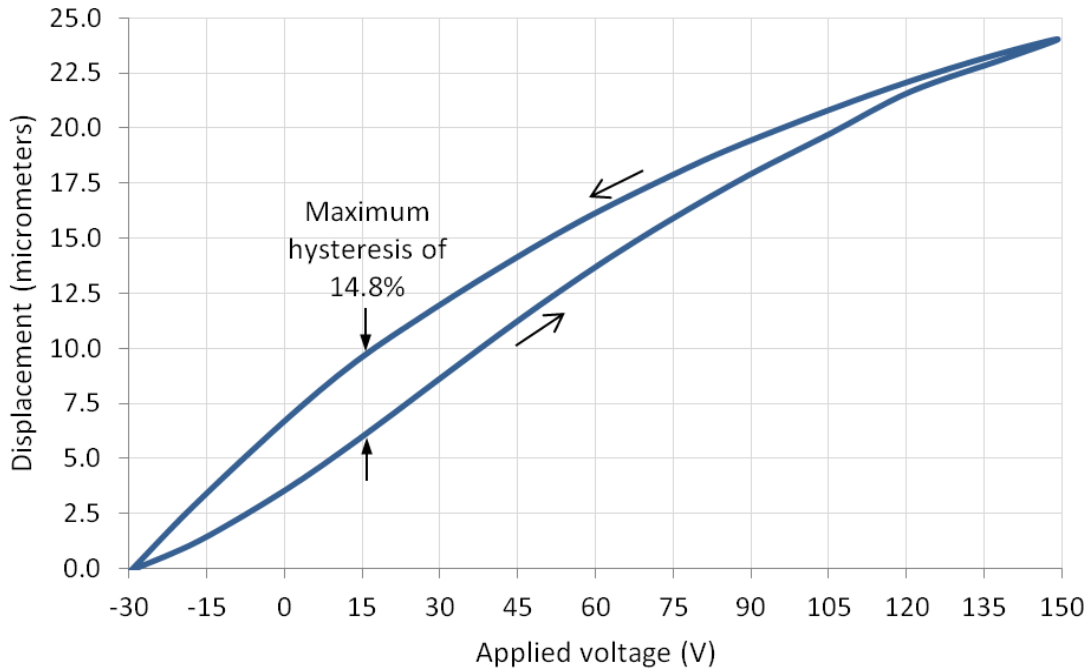

Figure C-2: Typical hysteresis curve of a piezoelectric stack actuator operating from -30V to +150V

Aerotech amplifiers take full advantage of the semi-bipolar operation of piezoelectric stack actuators. Our actuators are designated to operate from -30 V to +150 V with very high voltage resolutions. Over this voltage range, open-loop hysteresis values can be as large as 10-15% of the overall open-loop travel of the piezo stage. Operation of the piezo stage in a closed-loop effectively eliminates hysteresis of the actuator enabling positioning repeatabilities in the single-digit nanometer range.

C.3.3 Creep and Drift

The response time for a piezo ceramic subjected to an electric field is much faster than the reorientation time of the individual dipoles. This phenomenon causes undesirable behavior in open-loop position control. When an electric field is applied, the piezo stack will make a corresponding displacement almost instantaneously. If the field is then held constant, the piezo stack will continue to move slowly as the dipoles reorient, a phenomenon known as creep. It can take many minutes or even hours to reach steady state, with strain increasing by as much as 1% to 5% past the initial strained position. There is a similar effect called zero point drift. When an electric field is removed, the dipoles will gradually relax and motion will continue slowly until a steady state is reached. Operating the piezo actuator or stage in closed-loop control eliminates this drift because the controller is compensating for this movement in real time to keep the output motion at the desired position.

C.3.4 Force and Displacement

C.3.4.1 Force Versus Displacement Characteristics

The force generated by an actuator acting in the polarization direction is completely independent of the overall length of the actuator and is only a function of the cross-sectional area of the actuator and the applied electric field. An illustration of the force versus displacement output of a piezoelectric actuator with various applied voltages is shown in [Figure C-3](#).

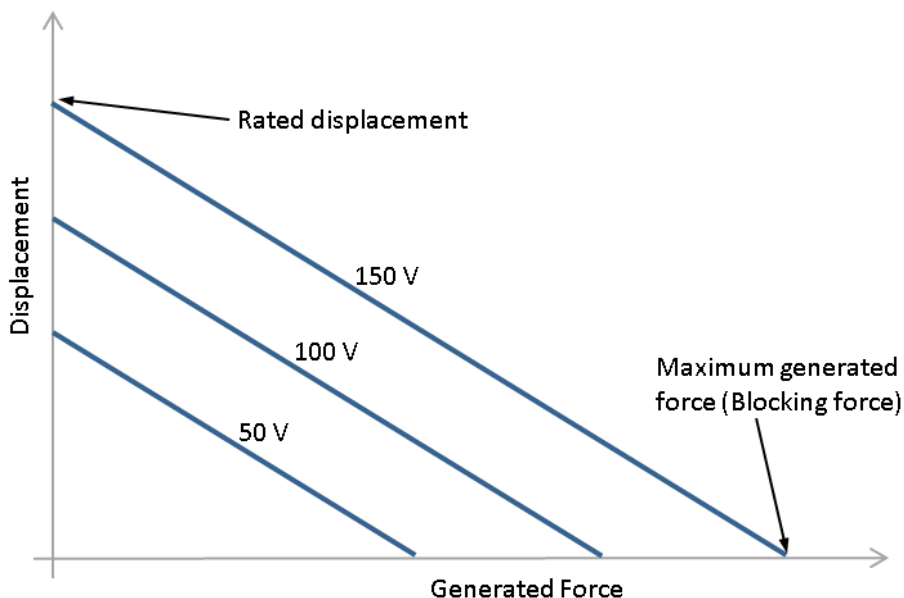

Figure C-3: Force vs. displacement output of a piezo actuator at various applied voltages

A few interesting characteristics become evident upon inspection of [Figure C-3](#). The piezo actuator's force and displacement increase as the applied voltage is increased. The maximum force output of a piezo actuator, or blocking force, occurs when the rated voltage is applied across the actuator and the output of the actuator is "blocked" or not allowed to move. As the actuator expands, the force production capability reduces until the force output reaches zero at the maximum rated displacement of the actuator.

C.3.4.2 Displacement With a Constant External Load

Figure C-4 illustrates the case of a piezo actuator or stage with a constant, external load applied.

In the case of a piezo stage or actuator without any applied load (case 1), the stroke of the piezo is given as ΔL_1 . When a mass is applied to the piezo stage (with expansion in the direction of gravity), the initial deflection (ΔL_0) is calculated as:

$$\text{Equation 2} \quad \Delta L_0 = \frac{F}{k_p} = \frac{m \cdot g}{k_p}$$

where k_p is the stiffness of the piezo stage in the direction of motion and m is the applied mass. With mass m applied to the piezo stage, the stage is compressed a distance ΔL_0 but the stroke ΔL_2 remains the same as the unloaded stage.

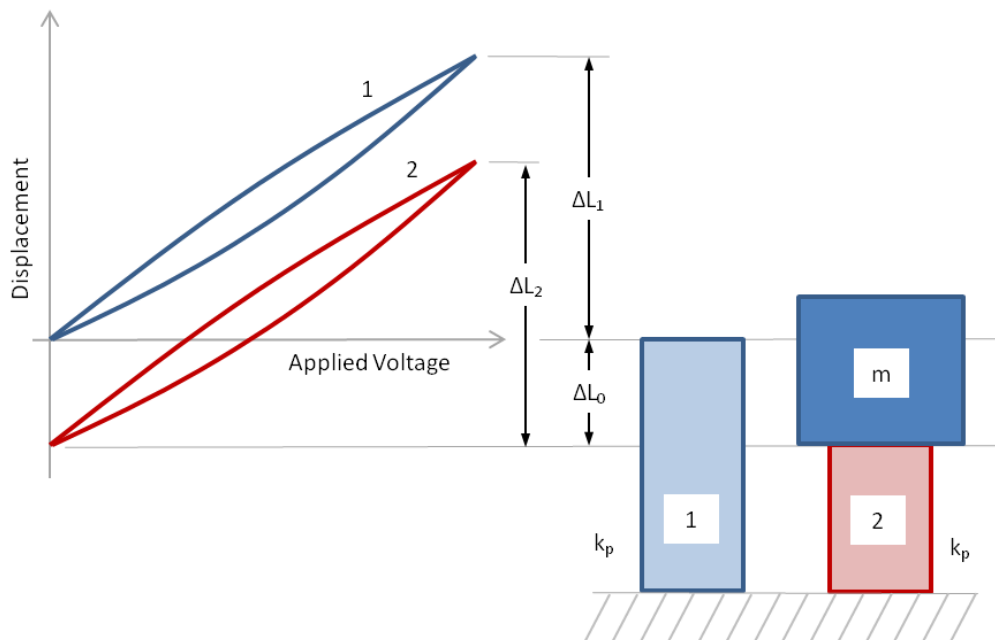

Figure C-4: Displacement of a piezo stage or actuator with a constant external load

That is:

$$\text{Equation 3} \quad \Delta L_2 = L_1 \text{ (constant, external load)}$$

C.3.4.3 Displacement With an External Spring Load

Figure C-5 illustrates a case where a piezo actuator or stage is driving against an external spring load.

In the case of a piezo stage or actuator without any applied load (case 1), the stroke of the piezo is given as ΔL_1 . For case 2 when driving against a spring load, the piezo stage stiffness (k_p) and the external stiffness (k_e) act in series and decrease the overall stroke of the actuator. The stroke in case 2 is given by:

$$\text{Equation 4} \quad \Delta L_2 = \frac{L_1 \cdot k_p}{(k_p + k_e)}$$

It is evident upon inspection of Equation 4 that in order to maximize the stroke of the piezo stage, the piezo stage stiffness (k_p) should be much larger than the external spring stiffness (k_e).

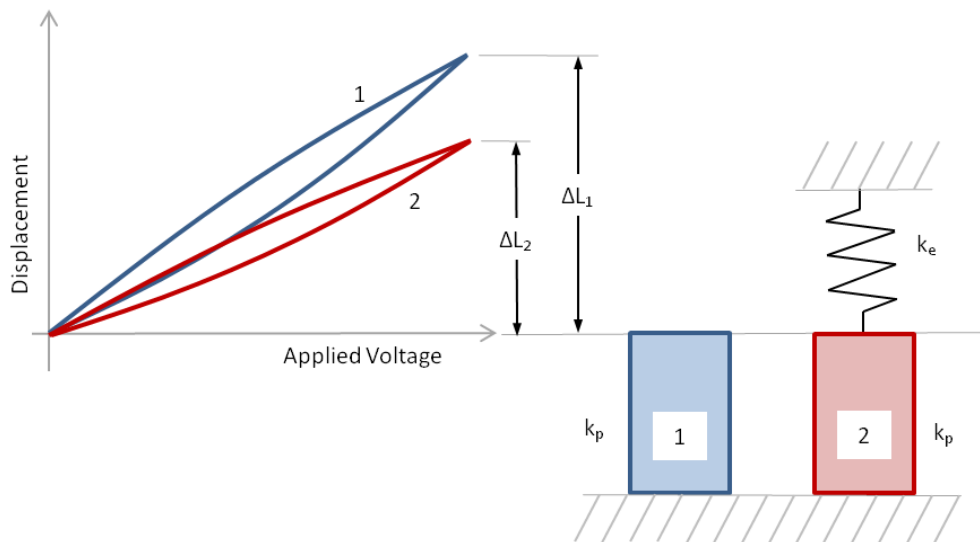

Figure C-5: Displacement of a piezo stage or actuator driving against an external spring of stiffness k_e

C.3.5 Capacitance

PZT actuators can be modeled electrically as a capacitor. The principle equation that describes a capacitor in terms of geometry and material properties is:

$$\text{Equation 5} \quad C = \epsilon \cdot \frac{A}{T}$$

where C is capacitance (units of F), A is the cross-sectional area of the capacitor perpendicular to the direction of the electric field (units of m^2), T is the thickness of the dielectric material separating the charge (units of m), and ϵ is the material permittivity of the dielectric material separating the charge. The material permittivity is described as:

$$\text{Equation 6} \quad \epsilon = \epsilon_r \cdot \epsilon_0$$

where ϵ_0 is the permittivity of a vacuum ($\sim 8.85 \times 10^{-12}$ F/m), and ϵ_r is the relative permittivity of the material (also called the dielectric constant).

Low-voltage, multi-layer actuators are generally used for nanopositioning because they allow for 0.1% to 0.15% nominal strains with low voltages (<200 V). The maximum applied electric field across these actuators are in the range of 1-4 kV/mm. Because these actuators are constructed from thin layers (typically 50 to 200 μm thick) separated by electrodes, the resulting applied voltages are lower (<200 V) compared to high-voltage actuators (~ 1000 V) where layer thickness is ~ 1 mm. The thickness of each layer (T_{layer}) can be defined as the overall active length of the piezo actuator (L_0) divided by the number of layers (n). The piezo stack capacitance of a multi-layer actuator can then be expressed as a function of the number of layers (n) and the overall active length (L_0), as follows:

$$\text{Equation 7} \quad C = n^2 \cdot \epsilon \cdot \frac{A}{L_0}$$

Typical capacitances of low-voltage, multi-layer piezo actuators used in nanopositioning applications are between 0.01 to 40 μF . The capacitances specified in Aerotech data sheets are measured at small signal conditions (1 V_{rms} at 1 kHz). For larger signal operation (100-150 V), an increase in capacitance by as much as 60% should be expected. This capacitance increase should be used when performing sizing calculations (see Section 5).

The current (i) flowing through a capacitor (C) is proportional to the change in voltage with respect to time. This is mathematically represented as:

$$\text{Equation 8} \quad i = C \cdot \frac{dV}{dt}$$

This simple relationship will be needed to adequately size amplifiers required to drive piezoelectric stages (see Section 5).

C.3.6 Heating and Power Dissipation

An ideal capacitor does not dissipate any power in terms of heat. However, in practice a piezo actuator does not act as an ideal capacitor and does have some internal resistance that generates heat when current is flowing through the actuator. The dielectric loss factor, or loss tangent, is defined as:

$$\text{Equation 9} \quad \tan \delta = \frac{ESR}{X_c}$$

where ESR is the equivalent series resistance of the capacitor and X_c is the capacitive reactance. The loss tangent can also be written as the ratio of active (resistive) power (P) to reactive power (Q):

$$\text{Equation 10} \quad \tan \delta = \frac{P}{Q}$$

The higher the loss tangent, the more energy is converted to heat (energy lost) as an alternating electric field is introduced to the material. For soft PZT materials, which are typically used for nanopositioning applications, the loss tangent generally is between .01 to .03 for lower amplitude signals (~1-10 volts) and can be as high as 0.1 to 0.25 for higher amplitude signals (~50-100 volts).

The reactive power (Q) is defined as:

$$\text{Equation 11} \quad Q \approx \frac{V_{rms}^2}{X_c}$$

For a single frequency (f) the capacitive reactance is:

$$\text{Equation 12} \quad X_c = \frac{1}{(2 \cdot \pi \cdot f \cdot C)}$$

Using [Equation 10](#), [Equation 11](#) and [Equation 12](#), it can be shown that the power dissipated in a piezo actuator for a sinusoidal voltage with an amplitude of $V_{pp}/2$ and frequency f is:

$$\text{Equation 13} \quad P \approx \frac{\pi}{4} \cdot \tan \delta \cdot f \cdot C \cdot V_{pp}^2$$

[Equation 13](#) is a very useful approximation and shows the effects of power loss in piezoelectric devices. This power loss is linearly proportional to the frequency of operation and the capacitance of the piezo actuator, and proportional to the applied time-varying voltage squared. Since voltage is proportional to position, the power loss is proportional to the square of the commanded time-varying position signal applied to the piezo stage.

[Figure C-6](#) shows an illustration of how the power loss changes as a function of frequency and applied voltage for a typical piezo actuator with a capacitance of 4 μ F.

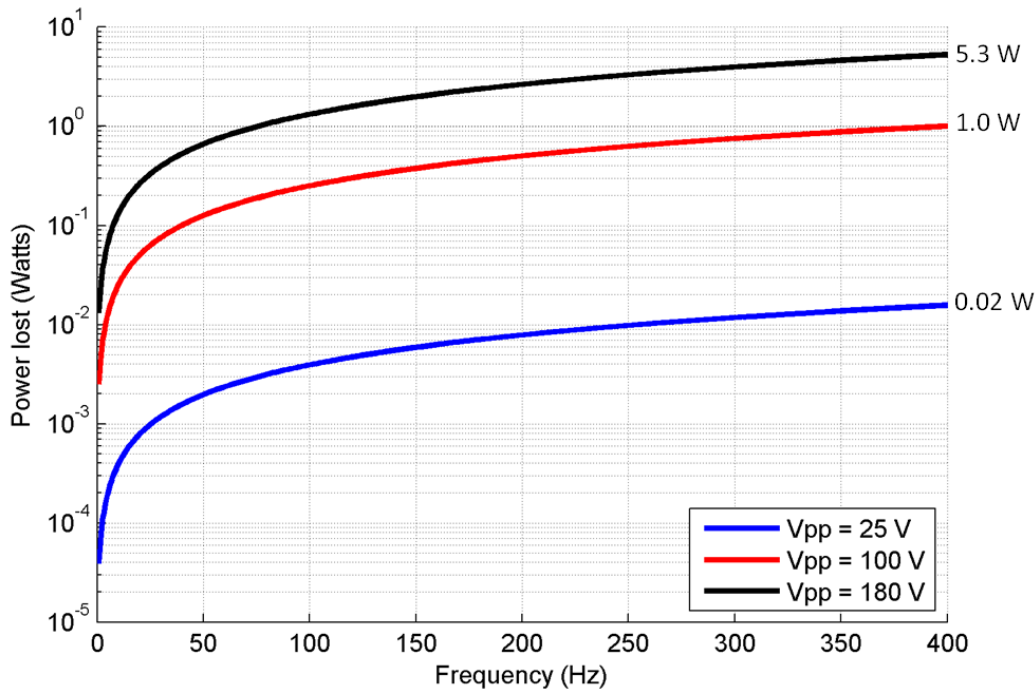

Figure C-6: Estimated power dissipated as a function of frequency and applied voltage for a typical piezo actuator with a 4 μ F capacitance

Temperature rise is proportional to the power dissipated in the actuator. To determine the temperature rise of the piezo actuator or stage requires in-depth knowledge of the exact stage characteristics and design (materials, contact area, etc.). By examining [Figure C-6](#), one can see that heating typically only becomes a concern at very large signal amplitudes (e.g., high voltage or large amplitude position) and high frequencies. For most positioning applications, the power dissipation and temperature rise in a piezo nanopositioning stage is negligible. For applications requiring large position oscillations and high frequencies, contact Aerotech's Application Engineering Department.

We will be happy to assist you in sizing the correct piezo nanopositioning device for your exact application.

C.3.7 Environmental Effects

C.3.7.1 Humidity

One of the most important factors for ensuring long life is to protect the piezo actuator against humidity. For this reason, Aerotech uses specially-sealed coatings on the actuators that protect the actuator from moisture. Operation at 60% or lower RH environments is preferred as it helps further prolong the life of the actuator.

C.3.7.2 Temperature

Piezo actuators can be designed to operate at very high temperatures and extremely low temperatures (cryogenic). The extreme upper limit of operation is the Curie temperature of the piezo material. At this temperature, the piezo material loses its piezoelectric effect. Curie temperatures of piezo actuator materials fall between 140°C and 350°C. However, piezoelectric properties are temperature dependent. For this

reason, the maximum temperature that Aerotech's piezo actuators can be used is approximately 80°C. In precision positioning applications, temperatures approaching this can cause serious detrimental effects to the accuracy and performance of the piezo stage.

Piezo actuators are well-suited for operation at extremely low temperatures, as well. The crystals in piezoelectric material remain in their piezoelectric configuration no matter how low the temperature drops. Standard commercially available stack actuators can operate down to -40°C with no problems. The biggest issue in cold environments is not the piezo itself, but induced stress from thermally contracting mechanisms. For extremely cold environments, special design considerations are required for the actuator to survive the cooling process. Carefully chosen electrodes and extremely homogeneous ceramic must be used to prevent cracking because of unmatched thermal expansion coefficients.

Piezo ceramics do operate differently at low temperatures. At these low temperatures, the ceramic stiffens, which causes a decrease in the amount of strain generated per volt. This is offset by increased electrical stability in the crystal structure, allowing fully bi-polar operation. Other advantages of low temperature operation include lower hysteresis, better linearity, lower capacitance and smaller dielectric loss.

For the highest accuracy, Aerotech recommends operation at or near 20°C because that is the temperature in which the nanopositioning stages are built and calibrated. Contact an Aerotech Applications Engineer if extreme temperature environments are expected in your operation as we will assist you in selecting or customizing the proper piezo positioning stage for the highest level of performance in any environment.

C.3.7.3 Vacuum

Low-voltage (<200 V) piezo acutators are particularly well-suited for vacuum operation. Piezo actuators do not require lubrication that typically requires great care when selecting for ultra-high vacuum applications. Vacuum pressures from 10 to 10^{-2} Torr need to be avoided because the insulation resistance of air dramatically decreases in this range (known as the corona area), thus allowing easier dielectric breakdown. Aerotech's piezo nanopositioning stages can be prepared for ultra-high vacuum operation.

C.4 Piezo Stage Properties and Nomenclature

Aerotech's piezo nanopositioning stage series are designed with the end-user in mind. As a result, it is important that our customers have a thorough understanding of our specifications so that they can best be matched to the application or end-process. The following is a description of the specifications and nomenclature used in our data sheets.

C.4.1 Accuracy/Linearity

As discussed in Section 3.2, piezo actuators exhibit hysteresis and non-linearity when operated on open-loop mode. When operating in closed-loop mode, the non-repeatabilities due to piezo actuator hysteresis are eliminated. However, the piezo stage may still exhibit non-linearities and hysteresis that affect the overall positioning accuracy of the device. The magnitude of these non-linearities are a function of the quality of the closed-loop feedback sensor and electronics used in the design, as well as the quality of the mechanical stage design. With our high-resolution capacitance sensors, advanced electronics and optimized flexure designs, linearity errors below 0.02% are achievable. Accuracy and linearity are measured with precise laser interferometers at a distance of ~15 mm above the moving carriage of the piezo nanopositioner (unless otherwise noted).

The terms accuracy and linearity are sometimes used synonymously when describing the positioning capability of piezoelectric nanopositioners. However, they can have subtle differences in meaning.

Accuracy is defined as the measured peak-peak error (reported in units of micrometers, nanometers, etc.) from the nominal commanded position that results from a positioning stage as it is commanded to move bidirectionally throughout travel.

Linearity is defined as the maximum deviation from a best-fit line of the position input and position output data. Linearity is reported as a percentage of the measurement range or travel of the positioning stage.

An example of the raw measurement results from an accuracy and linearity test is shown in [Figure C-7](#). The accuracy plot is shown in [Figure C-8](#). Notice how the accuracy results have a small residual slope remaining in the data. The deviation of a best-fit line to the measurement data taken in [Figure C-7](#) is used to calculate the linearity error. The residuals from this best-fit line and an illustration of how linearity error is calculated is shown in [Figure C-9](#).

In conclusion, the term accuracy is used to quantify both sensitivity effects (slope of measured versus actual position) as well as nonlinearities in positioning and is reported as a pk-pk value. The term linearity is used to quantify the effects of nonlinearities in positioning only and is reported as a maximum error or deviation of the residuals from the best fit line through the measured versus actual position data. The positioning accuracy can be approximated from the linearity specification by doubling the linearity specification. For example, a 0.02% linearity for a 100 μm stage is a 20 nm maximum deviation. The approximated accuracy error is $2 \times 20 \text{ nm}$ or 40 nm pk-pk.



Figure C-7: Raw measurement results from an accuracy and linearity test of a 100 μm piezo stage



Figure C-8: Example accuracy error calculated from the measurement data shown in [Figure C-7](#)



Figure C-9: Illustration showing how linearity is calculated based on measurement data taken from a 100 μm piezo nanopositioning stage

C.4.2 Resolution

Resolution is defined as the smallest detectable mechanical displacement of a piezo nanopositioning stage. Many piezo stage manufacturers will state that the resolution of a piezo actuator is theoretically unlimited because even the smallest change in electric field will cause some mechanical expansion (or contraction) of the piezo stack. Although theoretically true, this fact is largely impractical because all piezo actuators and stages are used with electronics and sensors that produce some amount of noise. The noise in these devices generally rises with increasing measurement sensor bandwidth. As a result, the resolution (or noise) of a piezo nanopositioner is a function of the sensor bandwidth of the feedback device. Aerotech's piezo amplifiers and feedback electronics have been optimized to provide low noise and high resolution making them suitable for some of the most demanding performance applications.

Aerotech specifies the resolution as a 1 sigma (rms) noise, or jitter, value as measured by an external sensor (either precision capacitance sensor or laser interferometer) at a measurement bandwidth of 1 kHz, unless noted. The stage servo bandwidth is set to approximately 1/3 to 1/5 of the 1st resonant frequency of the piezo nanopositioner because this is generally the highest frequency that the servo bandwidth can be increased to before servo instability occurs. Because the noise is primarily Gaussian, taking six times the 1 sigma value gives an approximation of the pk-pk noise. Unless specified, the measurement point is centered and at a height of approximately 15 mm above the output carriage. In noise critical applications, measuring at a lower servo bandwidth will result in a lower noise (jitter).

Values are specified for open-loop and closed-loop resolution. Open-loop resolution is governed only by the noise in the power electronics whereas closed-loop resolution contains feedback sensor and electronics noise as well as power amplifier noise.

C.4.3 Repeatability

The repeatability of Aerotech's QNPXY piezo nanopositioning stages is specified as a 1 sigma (standard deviation) value calculated from multiple bidirectional full-travel measurements. To obtain an *approximate* peak-peak value for bidirectional repeatability, multiply the 1 sigma value by 6. For example, a 1 nm value specified as a 1 sigma repeatability will be approximately 6 nm peak-peak.

C.4.4 Stiffness

The stiffness of a piezo actuator or nanopositioner is specified in the direction of travel of the output carriage. The stiffness is a function of the piezo stack, stage flexure and amplification mechanism(s) used in the design. Higher stiffness piezo stages allow for higher dynamics in positioning such as faster move and settle times and better dynamic tracking performance.

As mentioned in Section 3.1, most longer-travel (>50 μm) piezo flexure stages use lever amplification to achieve longer travels in a more compact package size. Lever amplification designs cause the stiffness in the direction of travel (inversely proportional to the square of the lever amplification ratio) to be reduced when compared to a directly-coupled design. Also, most lever amplification designs cause the stiffness of the actuator to change depending on location in travel due to the non-linear nature of the amplification gain. For this reason, along with manufacturing and device tolerances, the stiffness of Aerotech's piezo nanopositioning stages is specified at a nominal value of $\pm 20\%$.

Aerotech piezo nanopositioning stages are optimized to provide both premium dynamic performance and a compact stage package.

C.4.5 Resonant Frequency

The resonant frequency of a nanopositioning stage can be estimated as follows:

$$\text{Equation 14} \quad f_n = \frac{1}{(2\pi)} \cdot \sqrt{\left(\frac{k}{m_{eff}}\right)}$$

where f_n is the resonant frequency (Hz), k is the stiffness of the piezo nanopositioner (N/m) and m_{eff} is the effective mass of the stage (kg).

In a very general sense, it is typically the first (lowest) resonant frequency of the positioning system that limits the achievable servo bandwidth. The design of the flexure, supporting mechanics and piezo actuator stiffness govern the location of this resonant frequency. Aerotech has optimized the dynamics of our nanopositioning piezo stages to provide a stiff, high-resonant frequency design in an optimal stage package.

By adding an applied mass to the piezo stage, the resonant frequency will decrease by the following relationship:

$$\text{Equation 15} \quad f'_n = \frac{1}{(2\pi)} \cdot \sqrt{\left(\frac{k}{m_{eff} + m_{load}}\right)}$$

where m_{load} is the mass of the applied load.

In lever amplification designs, the stiffness can change throughout travel, as mentioned above. As a result, the resonant frequency will change by the square root of the change in stiffness. For example, if the stiffness changes by 7%, the resonant frequency will shift by approximately 3.4% throughout travel. [Equation 14](#) and [Equation 15](#) will provide a first-order approximation of resonant frequency in piezo nanopositioning systems. Complex interactions of the dynamics due to damping, nonlinear stiffnesses and mass/inertia effects cause these calculations to provide only an approximation of the resonant frequency. If a more exact value is required for your application or process, please contact us and we will assist in the design and analysis of an engineered solution.

Aerotech specifies the resonant frequency of our piezo nanopositioning stages at a nominal value with a $\pm 20\%$ tolerance along with the given payload (unloaded, 100 grams, etc.).

C.4.6 Load Ratings

Piezo actuators are ceramic materials and are brittle. As with most ceramics, PZTs have a higher compressive strength than tensile strength. The actuators used in our stage designs are preloaded so as to always maintain a compressive load state during standard operational limits. On our data sheets, we specify push and pull load limits that refer to loading applied in the direction of travel. For some stages, the load rating may be different depending on the direction of the applied load. All Aerotech load ratings are a maximum value. If you require larger load ratings than what is provided in our data sheets, please contact an Aerotech Applications Engineer as we may be able to easily modify or customize a design to meet your exact needs.

C.4.7 Expected Lifetime

The critical guidance elements in Aerotech piezo actuator flexure stages are sized using FEA and analytical techniques to ensure long, reliable operation. The materials and dimensions chosen for these flexure elements ensure elastic bending and stresses in critical areas well below the endurance limit.

Factors such as humidity, temperature and applied voltage all affect the lifetime and the performance of piezo actuators. As discussed in Section 3.7, our actuators are sealed and life-tested to ensure thousands of hours of device life. Based on empirical data developed over years of testing, we can provide lifetime estimates based on the desired move profiles and expected environmental conditions where the piezo nanopositioning system will reside.

C.5 Amplifier Selection

This section gives a basic overview for selecting a piezo amplifier based on a given piezo actuator and move profile.

Because the displacement of a piezo stage is proportional to the applied voltage, the basic travel is defined by the operating voltage of the amplifier. In our data sheets for open-loop operation, a voltage range is given alongside the open-loop travel. Typically, the closed-loop travel is less than the open-loop travel because closed-loop control usually requires larger voltage margins to achieve equivalent travels (due to hysteresis, dynamic operation, creep, etc.). Although the margins used for closed-loop control are stage and application dependent, it is conservative and safe to assume that closed-loop travel is achieved using the voltage range specified for open-loop control.

Most applications require some form of dynamic operation. Even if the application is positioning a sample or optic at various points in travel and dwelling for long periods of time, the piezo stage will need to move to those positions.

At operational frequencies well below the piezo stack's lowest resonant frequency (typically 10s to 100s of kilohertz), the piezo stack acts as a capacitor. Recall [Equation 8](#) :

$$\text{Equation 16} \quad i = C \cdot \frac{dV}{dt}$$

Since voltage is proportional to position, the piezo actuator draws current any time the position changes (e.g., during velocity of the piezo stage). This is different than a typical Lorenz-style servomotor that only draws current during acceleration and deceleration (neglecting losses).

The output of our amplifiers are rated for continuous current and peak current. The continuous and peak currents are calculated as follows:

$$\text{Equation 17} \quad i_{cont} = i_{rms} = \sqrt{\frac{1}{T_1 - T_2} \int_{T_1}^{T_2} [i(t)]^2 dt}$$

$$\text{Equation 18} \quad i_{pk} = \max[i(t)]$$

The current requirements of the desired move profile should be compared against these specifications to determine if the amplifier is capable of sourcing the desired current to the piezo actuator.

The example curve shown in [Figure C-10](#) gives the maximum peak-peak voltage possible for an amplifier, based on the current ratings and frequency of operation for sinusoidal motion of various piezo stack capacitances.

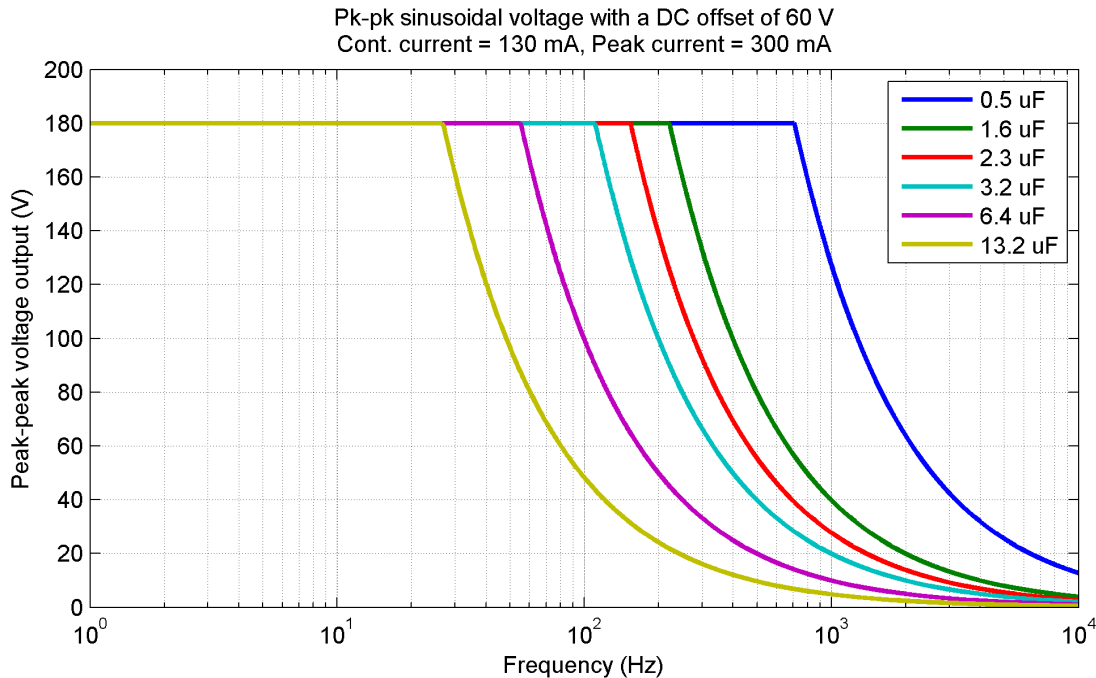

Figure C-10: Maximum sinusoidal peak-peak voltage of a given amplifier with various piezo stack capacitances

Consider the following additional examples of voltage, power and current calculations for selecting a piezo stage:

Example 1

A 100 μm pk-pk sinusoidal motion at 35 Hz is desired from a stage with a piezo capacitance of 5 μF . The selected amplifier has a semi-bipolar supply of +150 V/-30V, a 300 mA peak current rating and a 130 mA continuous current rating. Will this amplifier be able to supply enough current to perform this move?

Example 1 Calculations

Assume that to perform the 100 μm pk-pk motion, the full voltage range is used and at mid-travel, the voltage is at the mean of the rail voltages (e.g., 60 V). Therefore:

$$V(t) = 90 \cdot \sin(2 \cdot \pi \cdot 35 \cdot t) + 60$$

Recalling that the capacitance can increase by as much as 60% for large signal conditions, the capacitance used for this calculation is assumed to be 5 μF \cdot 1.6 = 8 μF . The current is then calculated as:

$$i(t) = (2 \cdot \pi \cdot 35) \cdot 90 \cdot 8e^{-6} \cdot \cos(2 \cdot \pi \cdot 35 \cdot t) = 0.158 \cdot \cos(2 \cdot \pi \cdot 35 \cdot t)$$

Therefore, $i_{\text{pk}} = 158 \text{ mA}$ and $i_{\text{rms}} = 112 \text{ mA}$. The voltage and current waveforms are shown in [Figure C-11](#).

In this example, the peak and continuous currents are all less than the amplifier rating. Therefore, this amplifier is capable of supplying the necessary current to perform the desired move profile.

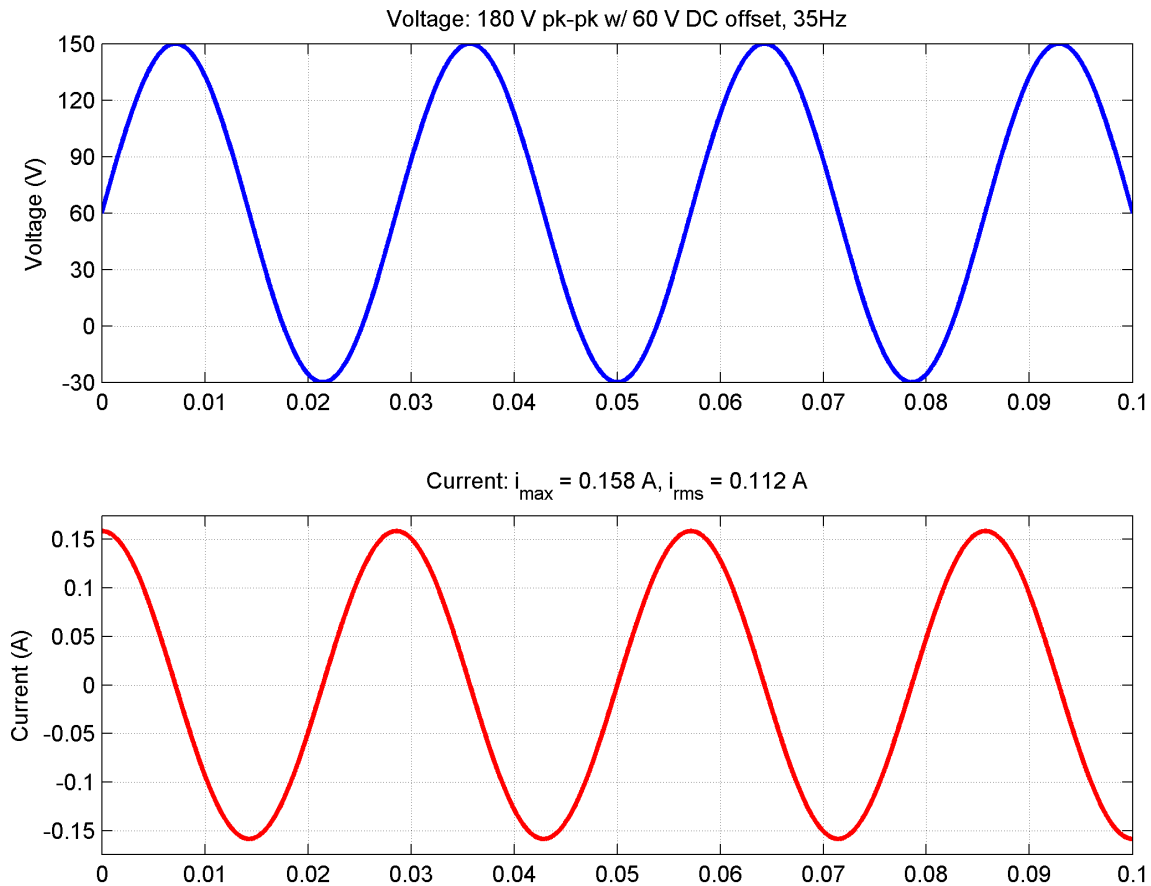

Figure C-11: Voltage and current waveforms for the profile commanded in [Example 1](#)

Example 2

A move from 0 to 100 μm in 4 ms, dwell for 60 ms, then move back from 100 μm to 0 in 4 ms is the desired output move profile of a stage with a piezo capacitance of 5 μF . The desired amplifier has a semi-bipolar supply of +150 V/-30 V, a 300 mA peak current rating and a 130 mA continuous current rating. Will this amplifier be able to supply enough current to perform this move?

Example 2 Calculations

The same calculations performed in [Example 1](#) are performed using [Equation 16](#), [Equation 17](#) and [Equation 18](#). Again, the capacitance is assumed to increase by approximately 60% due to large signal conditions. The voltage and current waveforms are shown in [Figure C-12](#).

In this example, the continuous current is below the rating of the amplifier. However, the peak current exceeds the maximum current rating of the amplifier. Therefore, this amplifier is NOT capable of supplying the necessary current and power to perform the desired move profile.

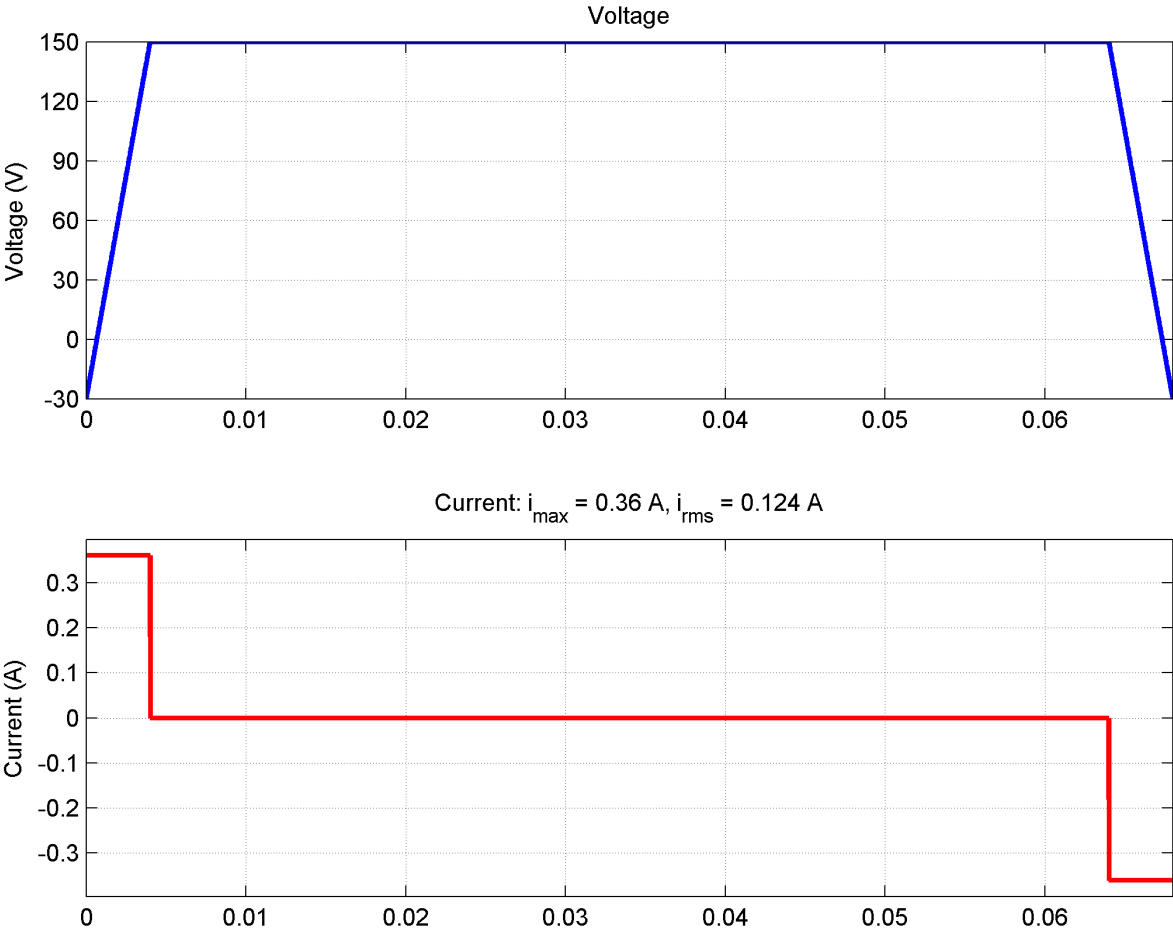

Figure C-12: Voltage and current waveforms for the profile commanded in Example 2

Index

		orthogonality	37
	2		
2014/35/EU		8	
	A		
Altitude		11	
Ambient Temperature		11	
	C		
CCW End-Of-Travel		35	
cleaning solvent		37	
Closed-Loop		10	
CW End-Of-Travel limit		35	
	E		
EN 61010-1		8	
End-of-Travel Limits		35	
	F		
field service		37	
	G		
Global Technical Support		2	
	H		
Humidity		11	
	I		
inspect		37	
	L		
label		15	
Linearity		12	
lubrication		37	
	M		
model number		15	
mounting surface		17	
multiaxis combinations		37	
	O		
Open-Loop		10	
		P	
		Protection Rating	11
		protective ground connection	30
		S	
		serial number	15
		Shimming	17
		Software Limits	35
		stabilize	15
		stage distortion	17
		Support	2
		T	
		Technical Support	2
		V	
		Vacuum Operation	14
		Vibration	11
		W	
		Warranty and Field Service	41

This page intentionally left blank.