

# Automation1 PS2 DIN Rail Power Supply

## HARDWARE MANUAL

Revision 1.01

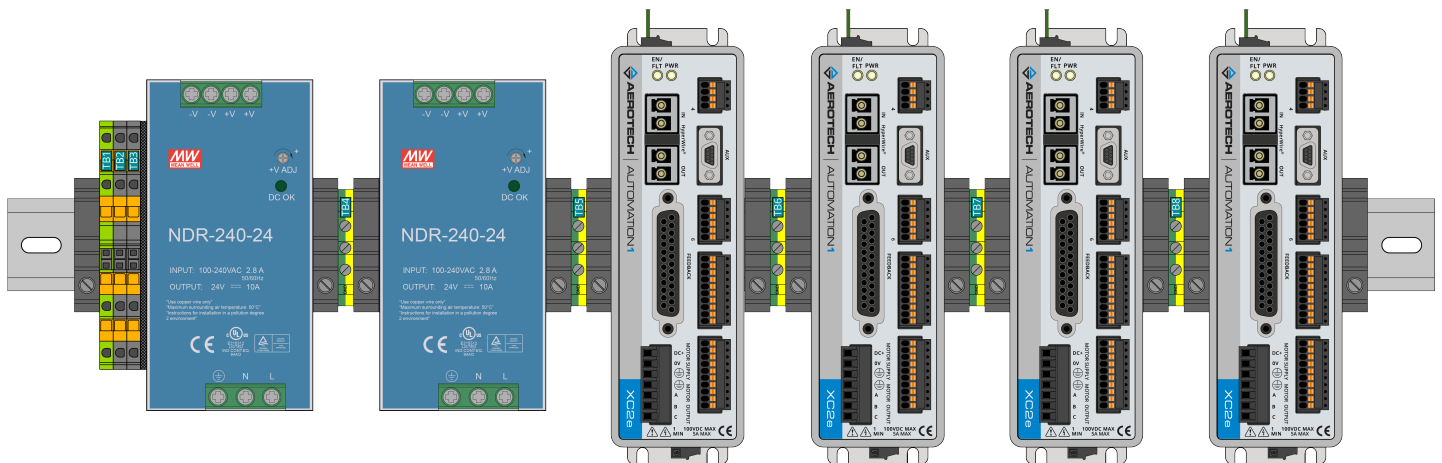

## GLOBAL TECHNICAL SUPPORT

Go to the [Global Technical Support Portal](#) for information and support about your Aerotech, Inc. products. The website supplies software, product manuals, Help files, training schedules, and PC-to-PC remote technical support. If necessary, you can complete Product Return (RMA) forms and get information about repairs and spare or replacement parts. To get help immediately, contact a service office or your sales representative. Include your customer order number in your email or have it available before you call.

This manual contains proprietary information and may not be reproduced, disclosed, or used in whole or in part without the express written permission of Aerotech, Inc. Product names mentioned herein are used for identification purposes only and may be trademarks of their respective companies.

Copyright © 2020-2021, Aerotech, Inc., All rights reserved.



## Table of Contents

<b>Automation1 PS2 DIN Rail Power Supply</b> .....	<b>1</b>
Table of Contents .....	3
List of Figures .....	4
List of Tables .....	4
EU Declaration of Conformity .....	5
Safety Procedures and Warnings .....	7
<b>Chapter 1: Introduction</b> .....	<b>9</b>
1.1. Electrical Specifications .....	10
1.2. Mechanical Specifications .....	11
1.2.1. Mounting and Cooling .....	11
1.2.2. Dimensions .....	11
1.3. Environmental Specifications .....	15
<b>Chapter 2: Installation</b> .....	<b>16</b>
2.1. Drive Installation .....	17
2.2. Wiring Installation .....	18
2.2.1. PS2 Wiring Diagrams .....	19
<b>Chapter 3: Maintenance</b> .....	<b>23</b>
<b>Appendix A: Warranty and Field Service</b> .....	<b>25</b>
<b>Appendix B: Revision History</b> .....	<b>27</b>
<b>Index</b> .....	<b>29</b>

## List of Figures

Figure 1-1: Automation1-PS2-D1-P1 Dimensions .....	11
Figure 1-2: Automation1-PS2-D1-P2 Dimensions .....	12
Figure 1-3: Automation1-PS2-D1-P3 Dimensions .....	12
Figure 1-4: Automation1-PS2-D1-P4 Dimensions .....	13
Figure 1-5: XC2/XC2e DIN Rail Clip Dimensions .....	13
Figure 1-6: NDR-240-24 and NDR-240-48 Dimensions .....	14
Figure 1-7: NDR-480-48 Dimensions .....	14
Figure 1-8: Drive Installation .....	17
Figure 1-9: Terminal Block Quick Connect .....	18
Figure 1-10: Automation1-PS2-D1-P1-AX04 .....	19
Figure 1-11: Automation1-PS2-D1-P2-AX02 .....	20
Figure 1-12: Automation1-PS2-D1-P3-AX04 .....	21
Figure 1-13: Automation1-PS2-D1-P4-AX02 .....	22

## List of Tables

Table 1-1: Configuration and Options .....	9
Table 1-2: Component Part Numbers .....	9
Table 1-3: Control Power Supply Specifications (A1) .....	10
Table 1-4: Motor Power Supply Specifications (-D1 option) .....	10
Table 1-5: Mounting Specifications .....	11
Table 1-6: User-Supplied AC Input Power Requirements .....	19
Table 2-1: Preventative Maintenance .....	23

## EU Declaration of Conformity

**Manufacturer** Aerotech, Inc.  
**Address** 101 Zeta Drive  
 Pittsburgh, PA 15238-2811  
 USA  
**Product** PS2  
**Model/Types** All

This is to certify that the aforementioned product is in accordance with the applicable requirements of the following directive(s):

2014/35/EU	Low Voltage Directive
2011/65/EU	RoHS 2 Directive
EU 2015/863	Amendment RoHS 3 Directive

and has been designed to be in conformity with the applicable requirements of the following standard(s) when installed and used in accordance with the manufacturer's supplied installation instructions.

IEC 61010-1:2010	Safety requirements for electrical equipment for measurement, control, and laboratory use
------------------	---

**Authorized Representative**

 / Simon Smith, European Director  
 Aerotech Ltd  
 The Old Brick Kiln, Ramsdell, Tadley  
 Hampshire RG26 5PR  
 UK

**Engineer Verifying Compliance**

 / Alex Weibel  
 Aerotech, Inc.  
 101 Zeta Drive  
 Pittsburgh, PA 15238-2811  
 USA  
 7/1/2021

**Date**



*This page intentionally left blank.*

## Safety Procedures and Warnings



**IMPORTANT:** This manual tells you how to carefully and correctly use and operate the power supply.

- Read all parts of this manual before you install or operate the power supply or before you do maintenance to your system.
- To prevent injury to you and damage to the equipment, obey the precautions in this manual.
- All specifications and illustrations are for reference only and were complete and accurate as of the release of this manual. To find the newest information about this product, refer to [www.aerotech.com](http://www.aerotech.com).

If you do not understand the information in this manual, contact Aerotech Global Technical Support.



**IMPORTANT:**

This product has been designed for light industrial manufacturing or laboratory environments. If the product is used in a manner not specified by the manufacturer:

- The protection provided by the equipment could be impaired.
- The life expectancy of the product could be decreased.



**WARNING: Electrostatic Discharge (ESD) Sensitive Components!**

You could damage the power supply or drives if you fail to observe the correct ESD practices.

Wear an ESD wrist strap when you handle, install, or do service to the PS2 assembly.



**DANGER: Risk of Electric Shock!**

- Before you install or do maintenance to the system, disconnect the electrical power. Ensure that an inadvertent circuit connection is not possible.
- Wait at least one (1) minute after you remove the power supply before you touch any part of the system.
- Do not connect or disconnect electrical components and cables while the system is connected to a power source.
- Do not connect primary and secondary sides of the power supply together.
- Do not remove the case of the power supply.
- Do not exceed the rated specifications of the output current or output wattage.
- Make sure that all components are grounded correctly and that they obey the local electrical safety requirements.
- Supply operators with the necessary precautions and protection from live electrical circuits.



**DANGER: Risk of Fire and Short Circuit!**

- Protect the power supply openings from foreign objects and liquids.
- Replace fuses only with a fuse of the same type and fuse rating.
- Do not install the system near water or in an environment with high moisture.
- Do not install the system in an environment with a high ambient temperature or near a fire source.



**IMPORTANT:** The power supply FG (⊕) must be connect to PE (Protective Earth).



**WARNING:** To prevent damage to the equipment and decrease the risk of electrical shock and injury, obey the precautions that follow.

1. Make sure that all system cables are correctly attached and positioned.
2. Do not use the cables or the connectors to lift or move this product.
3. Use this product only in environments and operating conditions that are approved in this manual.
4. Only trained operators should operate this equipment.



## Chapter 1: Introduction

The PS2 is a DIN rail mounted power supply for up to four axes.

**Table 1-1: Configuration and Options**

<b>Automation1 PS2</b>	
<b>Drive Type</b>	
-D1	DIN rail power supply for Automation1 XC2 and Automation1 XC2e
<b>Power Output</b>	
-P1	240 W @ 24 VDC
-P2	240 W @ 48 VDC
-P3	480 W @ 48 VDC
-P4	480 W @ 96 VDC
<b>Number of Axes</b>	
-AX01	One axis of wiring
-AX02	Two axes of wiring
-AX03	Three axes of wiring (-P1, -P3 only)
-AX04	Four axes of wiring (-P1, -P3 only)

**Table 1-2: Component Part Numbers**

<b>Description</b>	<b>Option</b>	<b>Aerotech p/N</b>	<b>Manufacturer P/N</b>
DIN Rail	N/A	EAM00914	Phoenix: 0801733
Drives	-D1	Automation1XC2	N/A
	-D1	Automation1XC2e	N/A
3-Position Mating Connector	N/A	ECK02456	Phoenix: 1839610
7-Position Mating Connector	N/A	ECK02457	Phoenix: 1839678
Terminal Blocks	N/A	ECK01530	Phoenix: 3205093
	N/A	ECK01529	Phoenix: 3205077
	N/A	ECK01402	C3 Controls: WTB2-W2/4G
	N/A	ECK01534	Phoenix: 3022276
	N/A	ECK01404	C3 Controls: WTB2-EB

## 1.1. Electrical Specifications



**IMPORTANT:** All specifications and illustrations are for reference only and were complete and accurate as of the release of this manual. To find the newest information about this product, refer to [www.aerotech.com](http://www.aerotech.com). Manufacturer websites will have the most up-to-date information on non-Aerotech products. Refer to [Table 1-2](#) for part numbers.

**Related Warnings:**



**Table 1-3: Control Power Supply Specifications (A1)**

Description	NDR-240-24 (ECZ02954)
Output Voltage	24 VDC
Output Current	10 A
Input Voltage	~100...240 VAC, 50/60 Hz (auto-ranging)
Input Current (Typical)	2.5 A @115 VAC 1.3 A @230 VAC
(1) Refer to the power supply manufacturer website for up-to-date specifications ( <a href="https://www.meanwell-web.com/en-gb/dinrail-powersupply/">https://www.meanwell-web.com/en-gb/dinrail-powersupply/</a> ).	
(2) Specifications are subject to change and were accurate as of the printing of this manual.	

**Table 1-4: Motor Power Supply Specifications (-D1 option)**

Description	NDR-240-24 (ECZ02954)	NDR-240-48 (ECZ02966)	NDR-480-48 (ECZ02965)	NDR-240-48 (x2) (ECZ02966)
Option #	-P1	-P2	-P3	-P4
Output Voltage	24 VDC @ 240 W	48 VDC @ 240 W	48 VDC @ 480 W	96 VDC @ 480 W
Output Current	10 A	5 A	10 A	5 A
Input Voltage	~100...240 VAC, 50/60 Hz (auto-ranging)			
Input Current (Typical)	2.5 A @ 115 VAC 1.3 A @ 230 VAC	2.5 A @ 115 VAC 1.3 A @ 230 VAC	4.8 A @ 115 VAC 2.4 A @ 230 VAC	2.5 A @ 115 VAC 1.3 A @ 230 VAC
(1) Refer to the power supply manufacturer website for up-to-date specifications ( <a href="https://www.meanwell-web.com/en-gb/dinrail-powersupply/">https://www.meanwell-web.com/en-gb/dinrail-powersupply/</a> ).				
(2) Specifications are subject to change and were accurate as of the printing of this manual.				

## 1.2. Mechanical Specifications



**IMPORTANT:** All specifications and illustrations are for reference only and were complete and accurate as of the release of this manual. To find the newest information about this product, refer to [www.aerotech.com](http://www.aerotech.com). Manufacturer websites will have the most up-to-date information on non-Aerotech products. Refer to [Table 1-2](#) for part numbers.

### 1.2.1. Mounting and Cooling

Install the PS2 in an IP54 compliant enclosure to comply with safety standards. Make sure that there is sufficient clearance around the power supplies and drives for free airflow and for the cables and connections.

**Table 1-5: Mounting Specifications**

		Description
Customer-Supplied Enclosure		IP54 Compliant
Weight		Option Dependent
Mounting Hardware (DIN rail)		#10-32 (or equivalent) screws (minimum of 3 locations)
Mounting Orientation		Vertical
Dimensions		Refer to <a href="#">Section 1.2.2. Dimensions</a>
Minimum Ventilation Clearances (approximate)	Sides	5 mm [0.2 in]; minimum of 100 mm [3.9 in] when next to a heat source
	Top	40 mm [1.6 in]
	Bottom	20 mm [0.8 in]
Minimum Clearance	Connectors	100 mm [3.9 in]
Operating Temperature		Refer to <a href="#">Section 1.3. Environmental Specifications</a>

### 1.2.2. Dimensions

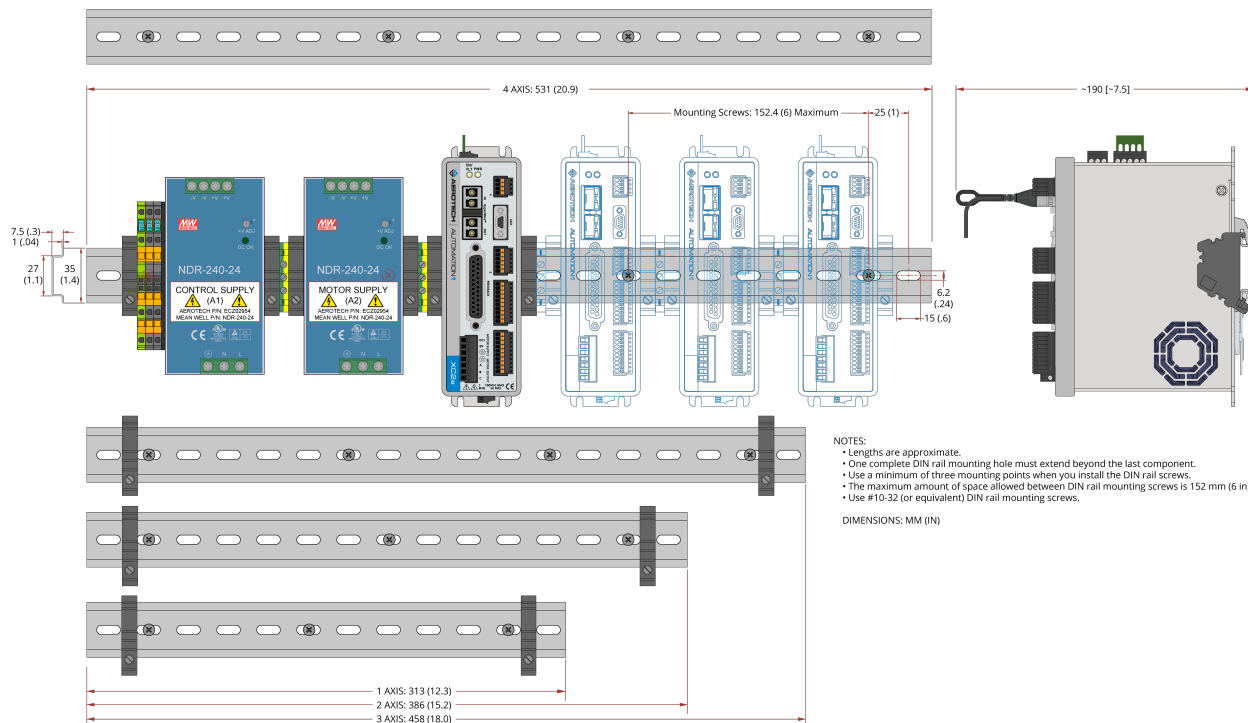

**Figure 1-1: Automation1-PS2-D1-P1 Dimensions**

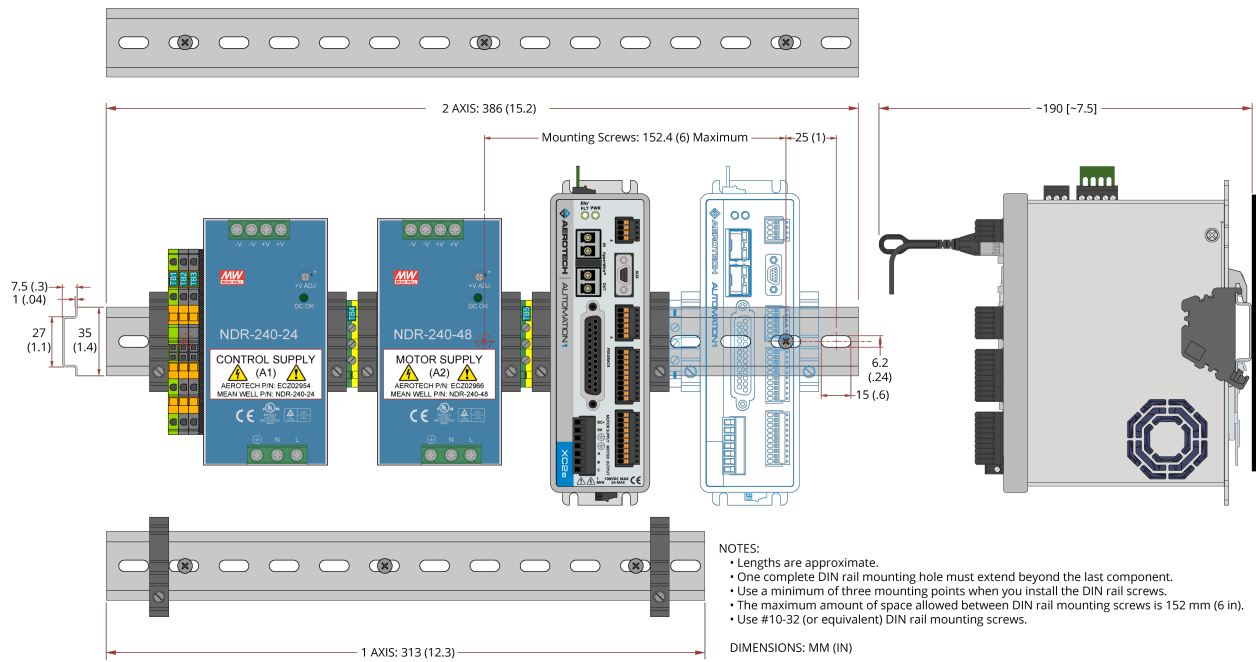

Figure 1-2: Automation1-PS2-D1-P2 Dimensions

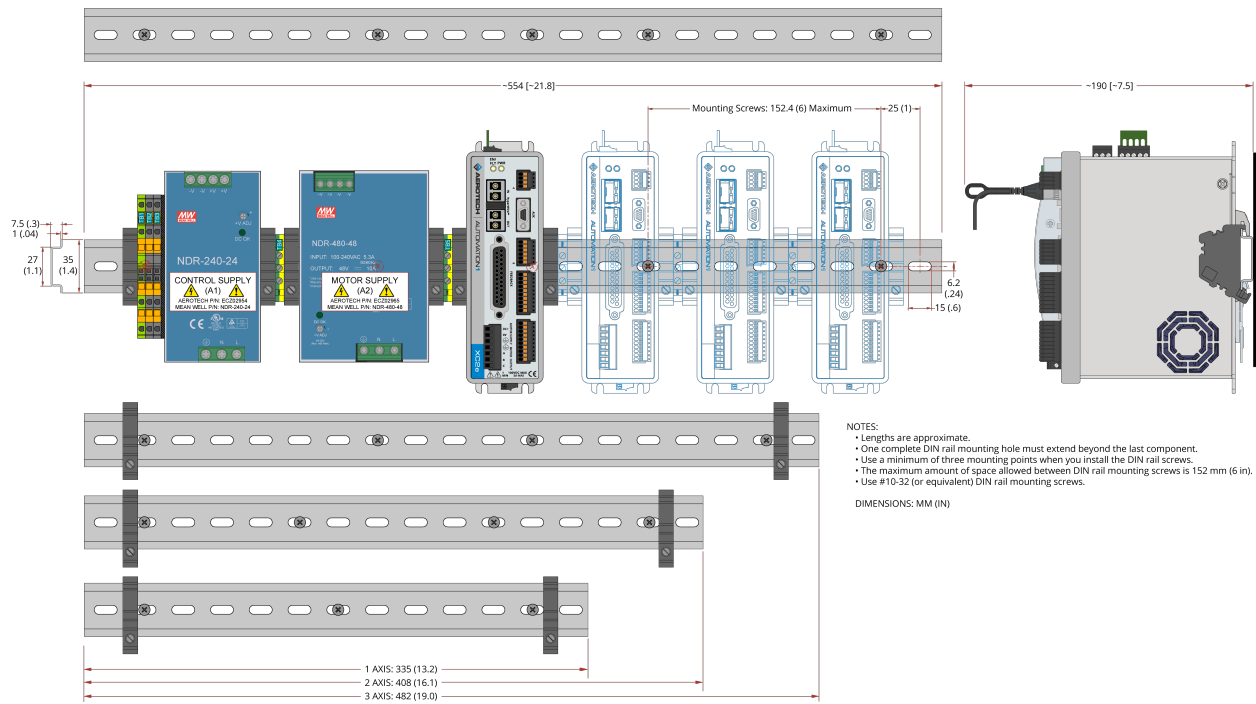

Figure 1-3: Automation1-PS2-D1-P3 Dimensions

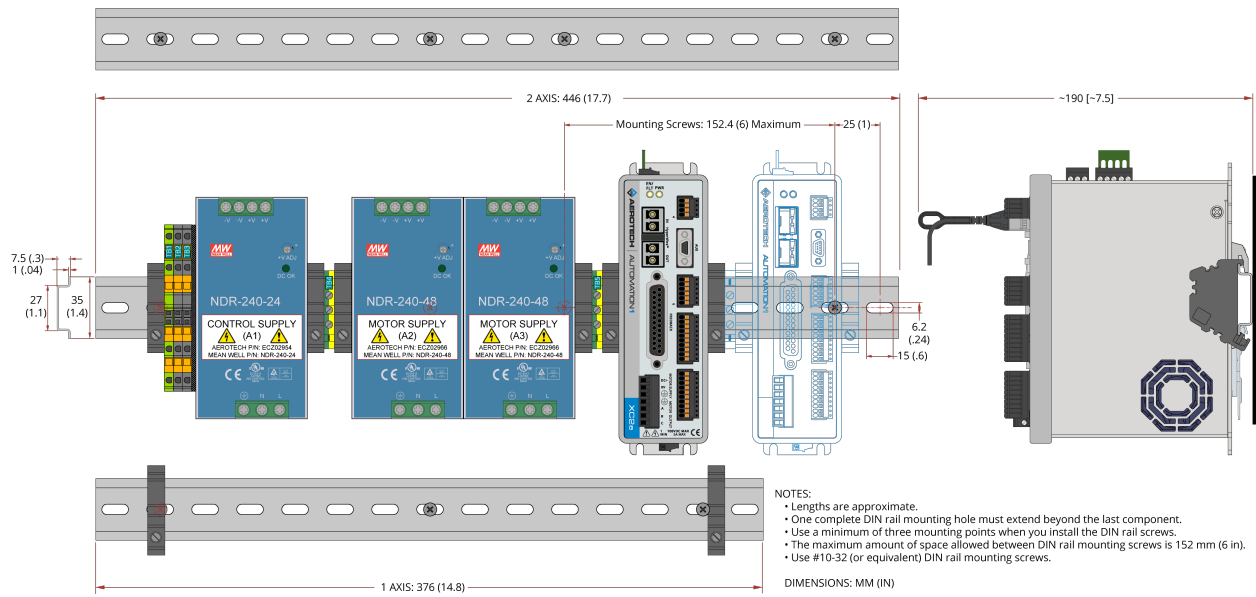

Figure 1-4: Automation1-PS2-D1-P4 Dimensions

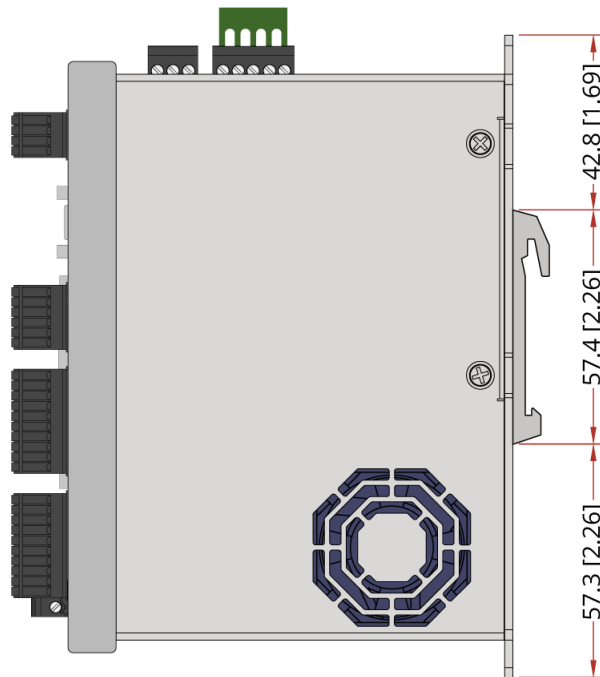

Figure 1-5: XC2/XC2e DIN Rail Clip Dimensions

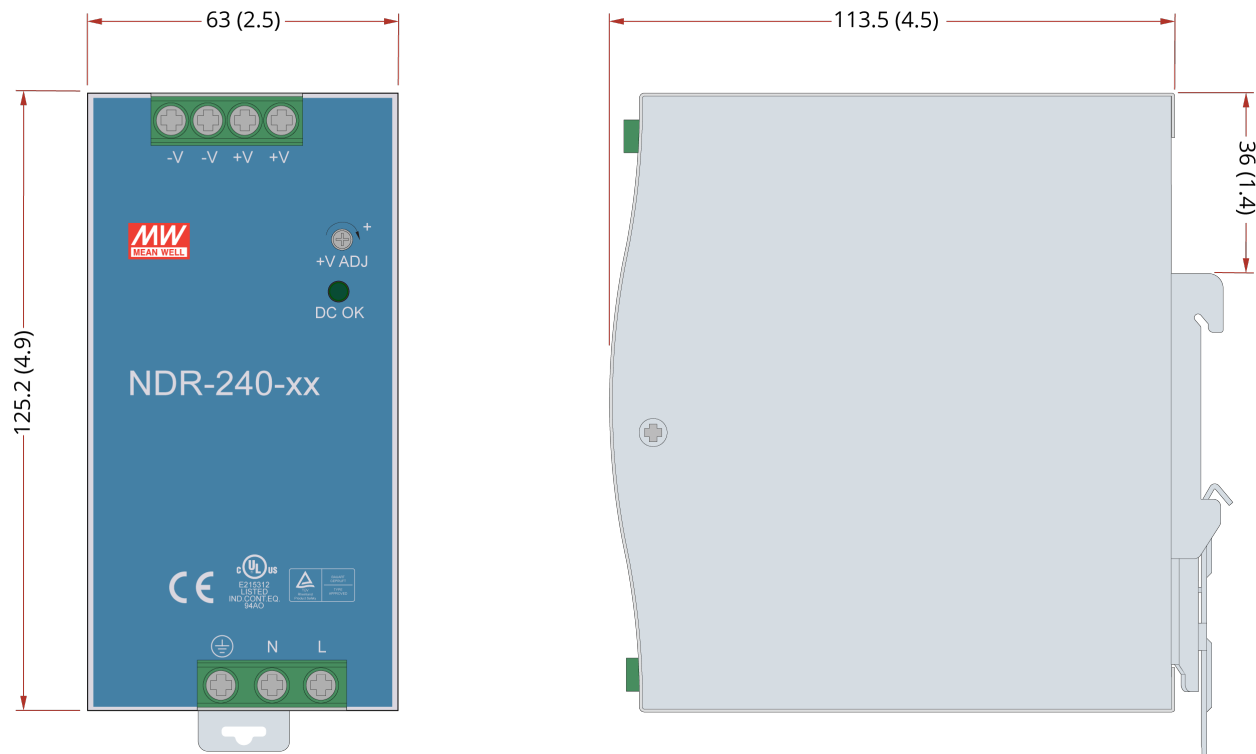

Figure 1-6: NDR-240-24 and NDR-240-48 Dimensions

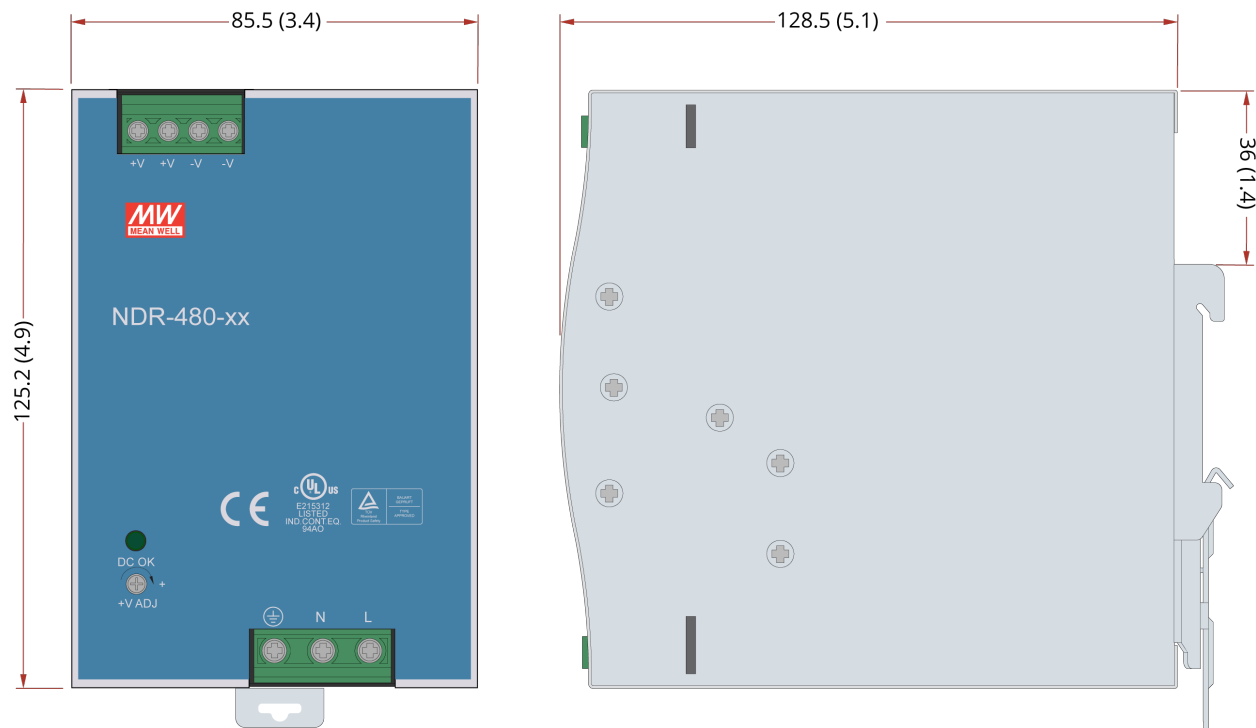

Figure 1-7: NDR-480-48 Dimensions

### 1.3. Environmental Specifications

The environmental specifications for the PS2 are listed below.

Ambient Temperature	Operating: 5° to 40°C (41° to 104° F)
	Storage: -20° to 70°C (-4° to 158° F)
Humidity	Maximum relative humidity is 80% for temperatures up to 31°C. Decreasing linearly to 50% relative humidity at 40°C. Non condensing.
Altitude	Up to 2000 meters.
Pollution	Pollution degree 2 (normally only non-conductive pollution).
Use	Indoor use only.

## Chapter 2: Installation

### Unpacking the Chassis



**IMPORTANT:** All electronic equipment and instrumentation is wrapped in antistatic material and packaged with desiccant. Ensure that the antistatic material is not damaged during unpacking.

**Related Warnings:**



Inspect the shipping container for any evidence of shipping damage. If any damage exists, notify the shipping carrier immediately.

Remove the packing list from the container. Make sure that all the items specified on the packing list are contained within the package.

The documentation for the PS2 is on the included installation device. The documents include manuals, interconnection drawings, and other documentation pertaining to the system. Save this information for future reference. Additional information about the system is provided on the Serial and Power labels that are placed on the PS2 chassis.

The system serial number label contains important information such as the:

- Customer order number (please provide this number when requesting product support)
- Drawing number
- System part number



## 2.1. Drive Installation

How to install an Automation1 drive on to the DIN rail:

1. Tilt the drive (refer to [Figure 1-8](#)).
2. Locate the drive clip over the DIN rail and slide the drive down over the top of the DIN rail.
3. Push the bottom of the drive until it locks against the bottom rail of the DIN Rail.
4. The drive clip should "click" into place. Carefully move the unit to ensure that the drive is correctly locked into place.

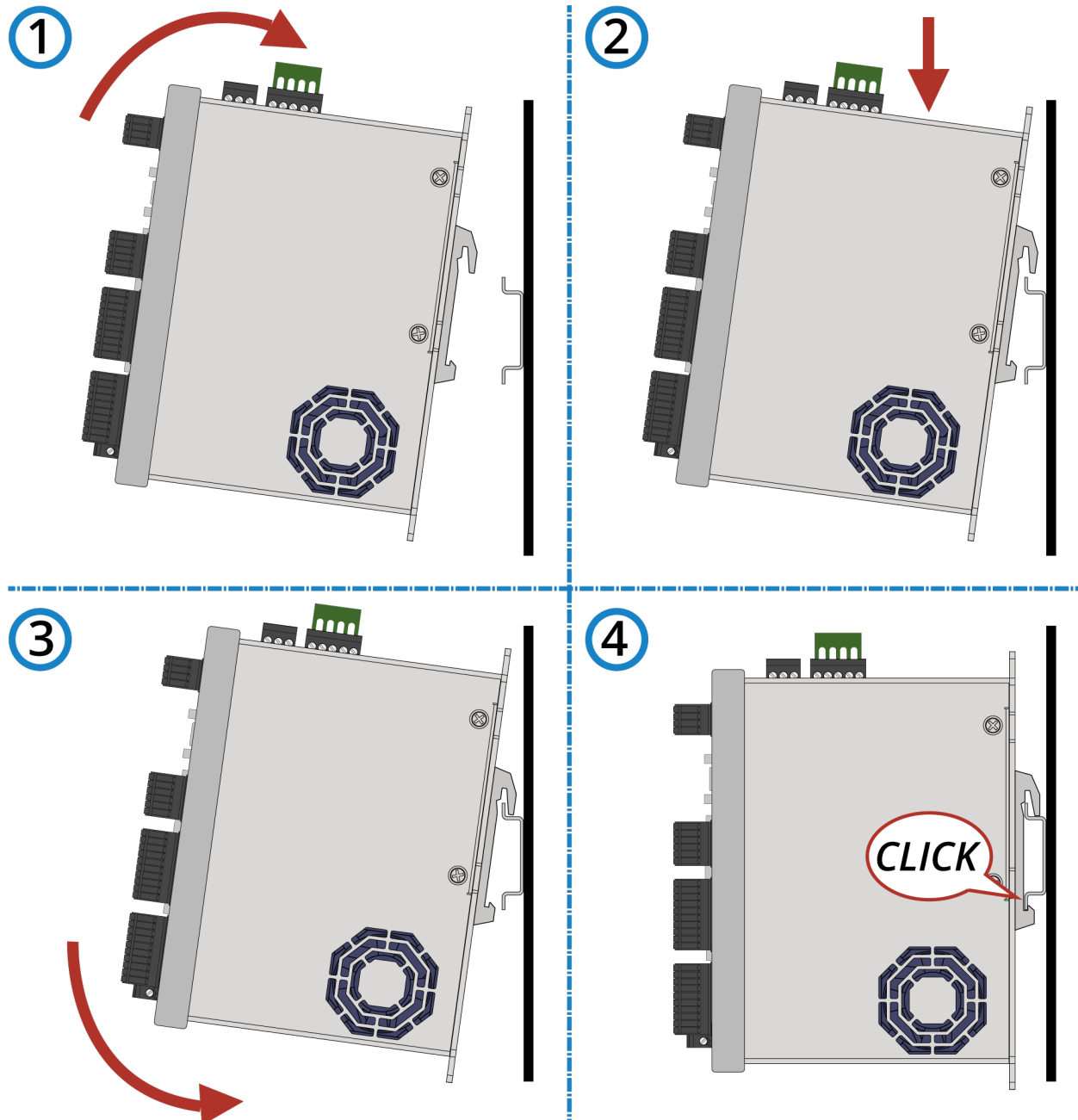

Figure 1-8: Drive Installation

## 2.2. Wiring Installation

### IMPORTANT: User/System Integrator External Wiring Requirements:



- If the PS2 hardware was purchased as an integrated system, refer to the "Systems Interconnections" drawing included with the system documentation. Otherwise, refer to the applicable drive Hardware Manual.
- Do not loosen factory wire terminations or change factory installed wiring on the PS2 assembly!
- The end-user/system integrator must supply an external ~100...240 VAC 50/60 Hz power supply.

### Related Warnings:



1. On the drive, remove the factory-installed Control Supply and Motor Supply/Motor Output terminal block connectors. Refer to [Section 2.2.1. PS2 Wiring Diagrams](#) or the drive hardware manual for connector locations.
2. Plug the PS2 pre-wired Control Supply and Motor Supply connectors into the drive.
3. Connect the external user-supplied AC supply at TB1 (⊕), TB2 N (L2), and TB3 L (L1). Refer to [Table 1-6](#), [Figure 1-9](#), and [Section 2.2.1](#).  
NOTE: TB1, TB2, and TB3 are Phoenix QT fast connection terminal blocks.
  - a. Insert the wire into the terminal block wire slot until it cannot be pushed in any further.
  - b. Hold the wire in place and insert a 3 mm slotted screwdriver into the orange slot-locking tab. Pull the screwdriver down to lock the wire into place.
  - c. Pull on the wire to verify that it is locked into place.
4. On the drive, make Motor Output and feedback connections as required by your system. Refer to the Systems Interconnection drawing or the drive hardware manual.
  - a. Motor Output: Required.
  - b. Feedback: Required.
  - c. HyperWire: Required.
  - d. Digital/Analog I/O: Optional.
  - e. AUX Encoder: Optional.

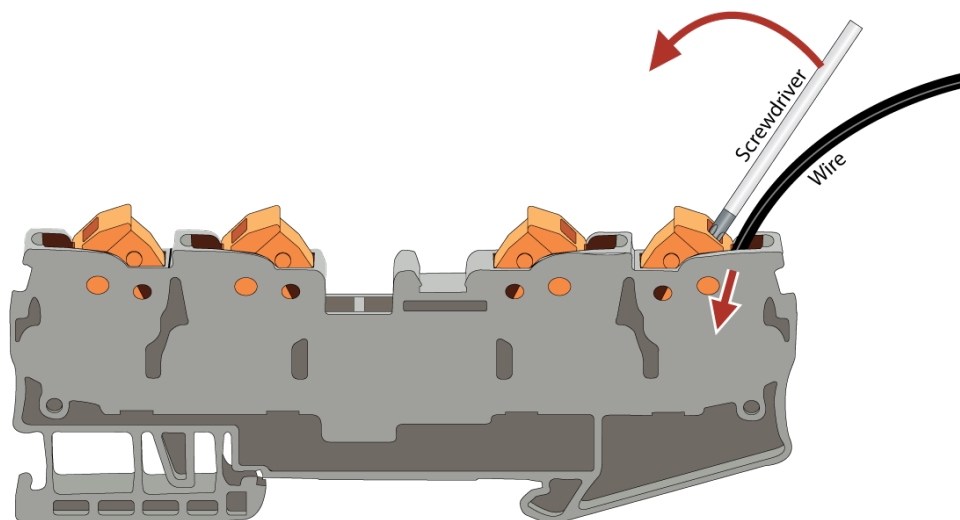

Figure 1-9: Terminal Block Quick Connect

**Table 1-6: User-Supplied AC Input Power Requirements**

Pin	Description	Wire Size (min)
AC1 (L)	AC Power	0.8 mm <sup>2</sup> (#18 AWG); 300 V
AC2 (N)	AC Power	0.8 mm <sup>2</sup> (#18 AWG); 300 V
	Protective Ground	0.8 mm <sup>2</sup> (#18 AWG); 300 V

NOTE:

- The user must provide 10 A, 250 VAC fuse(s) or circuit breaker(s) to protect the AC inputs.
- The AC supply wire leads require no terminations or insulation stripping.

**2.2.1. PS2 Wiring Diagrams**

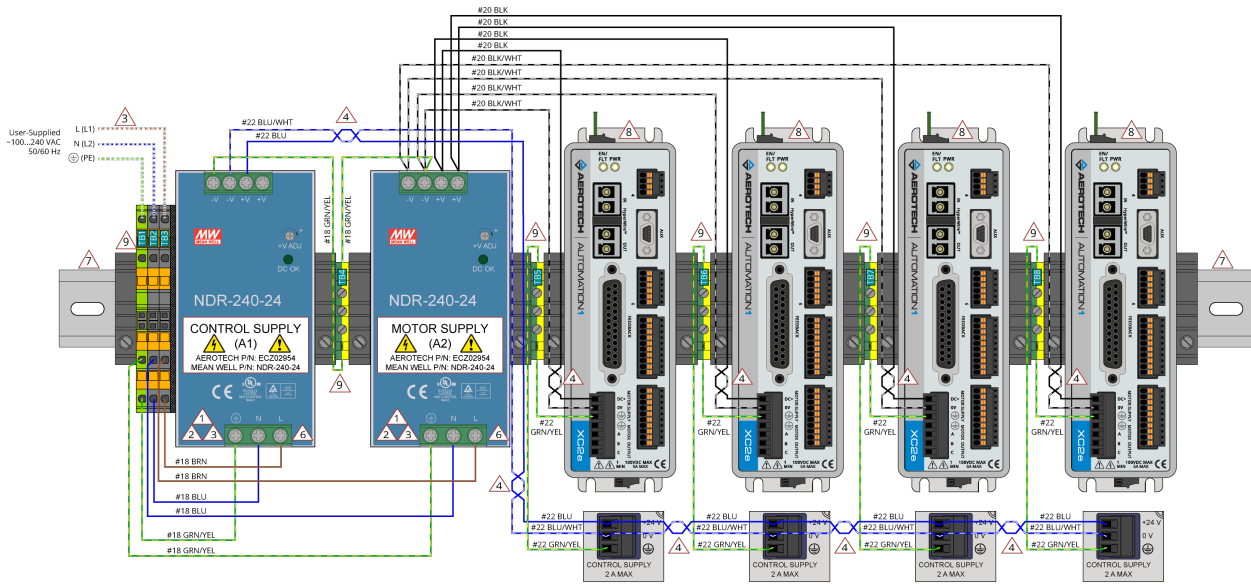

**! ! ATTENTION ! !**  
The system integrator or end user is responsible for all safety compliance and technical requirements for the system wiring.

**! IMPORTANT:** For Additional Safety Information, refer to:  
• the specific Automation1 drive hardware manual.  
• installation manuals from the power supply manufacturer.

**! DANGER: RISK OF ELECTRIC SHOCK!**  
• Disconnect power before you access the unit.  
• Do not connect primary and secondary sides of the power supply together.  
• Verify that the FG terminal (⊕) is connected to PE (Protective Earth).  
• Do not disassemble the PS2 assembly or its power supplies.

**! WARNING: Electrostatic Discharge (ESD) Sensitive Components!**  
You could damage the power supply or drives if you fail to observe the correct ESD practices.  
• Wear an ESD wrist strap when you handle, install, or do service to the assembly.

The information on this page is for reference only.

**! INSTALLATION**  
• Mount PS2 assembly only in the orientation shown. This will ensure convective airflow through the power supplies and that the DIN-rail components are correctly placed and locked.  
• For use in pollution degree 2 environment (only non-conductive pollution).  
• Install in an IP54 compliant chassis.  
• For use indoors in dry, well ventilated locations only (in a control cabinet, for example).  
• Mount each power supply vertically such that the AC input is at the bottom and the DC output at the top.

**! POWER SUPPLY (MEAN WELL)**  
• The L input is internally fused.  
• The N input is not internally fused.  
• The power supply units are UL508, TUV EN60950-1 approved.

MEAN WELL P/N	AEROTECH P/N	MAX AMBIENT TEMPERATURE	INTERNAL FUSE (A)
NDR-240-24	EC202954	50°C	5.0 A

**! AC INPUT POWER REQUIREMENTS**

PIN	DESCRIPTION	WIRE SIZE (min)
AC1 (L)	AC Power	0.8 mm <sup>2</sup> (#18 AWG); 300 V
AC2 (N)	AC Power	0.8 mm <sup>2</sup> (#18 AWG); 300 V
⊕	Protective Ground	0.8 mm <sup>2</sup> (#18 AWG); 300 V

NOTE: The user must provide 10 A, 250 VAC fuse(s) or circuit breaker(s) to protect the AC inputs.

**! All twisted wires must be twisted at least 2 turns/inch.**

**! Terminate all connections with wire ferrules where possible.**

**! System wiring is shown with a neutral line configuration. If applied A.C. does not contain a neutral, neutral line "N" must be correctly fused by the user.**

**! DIN RAIL SPECIFICATIONS (Aerotech P/N: EAM00914)**  
• DIN Rail Dimensions - Millimeters (Inches)

1-Axis	2-Axis	3-Axis	4-Axis
313 [12.3]	386 [15.2]	458 [18.0]	531 [20.9]

• The DIN Rail should be cut such that one complete mounting hole extends beyond the components on each end.  
• Use #10-32 (or equivalent) screws.

**! Use the DIN Rail Clip Kit (Aerotech P/N: XC2-DIN or XC2e-DIN) to mount the clip to the drive and then the drive to the DIN Rail.**

**! Terminal Block Selection Chart**

TB1	4-Position Terminal Block: GROUND (Aerotech P/N: ECK01530)
TB2, TB3	4-Position Terminal Block: POWER (Aerotech P/N: ECK01529)
TB3	Terminal Block Cover: FOR TB3 (L1) (Aerotech P/N: ECK01533)
TB4, TB5, TB6	2-Position Terminal Block: GROUND (Aerotech P/N: ECK01402)
n/a	End Barrier: Clamp (Aerotech P/N: ECK01404)

**Figure 1-10: Automation1-PS2-D1-P1-AX04**

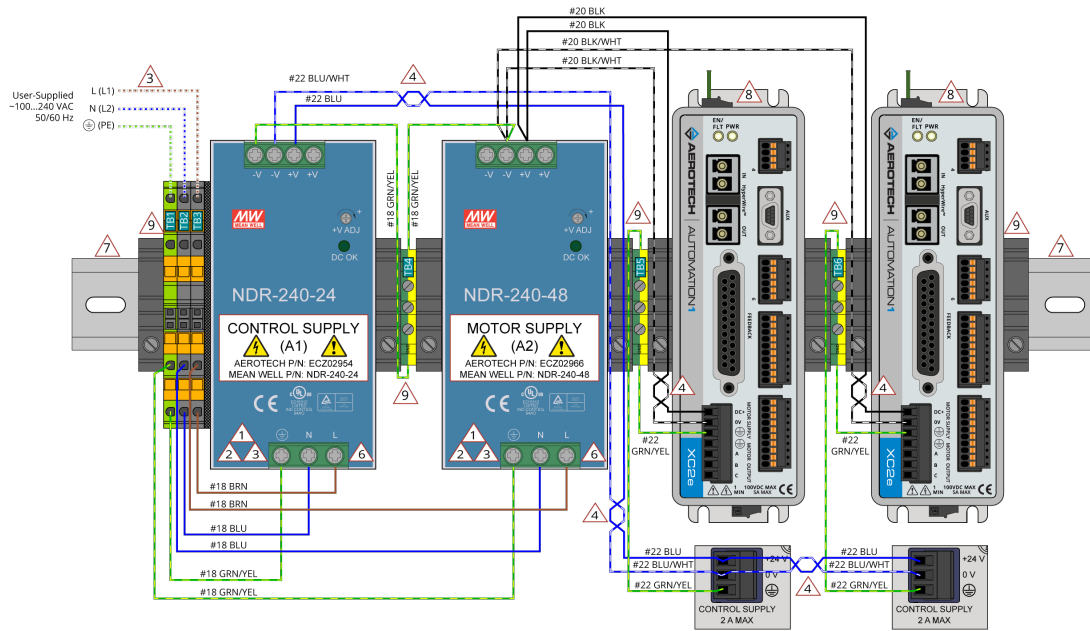

**⚠ ATTENTION ⚠**  
The system integrator or end user is responsible for all safety compliance and technical requirements for the system wiring.

**! IMPORTANT:** For Additional Safety Information, refer to:  
 • the specific Automation1 drive hardware manual.  
 • installation manuals from the power supply manufacturer.

**⚠ DANGER: RISK OF ELECTRIC SHOCK!**  
 • Disconnect power before you access the unit.  
 • Do not connect primary and secondary sides of the power supply together.  
 • Verify that the FG terminal (⊕) is connected to PE (Protective Earth).  
 • Do not disassemble the PS2 assembly or its power supplies.

**⚠ WARNING:** Electrostatic Discharge (ESD) Sensitive Components!  
 You could damage the power supply or drives if you fail to observe the correct ESD practices.  
 • Wear an ESD wrist strap when you handle, install, or do service to the assembly.

**3** INSTALLATION  
 • Mount PS2 assembly only in the orientation shown. This will ensure convective airflow through the power supplies and that the DIN-rail components are correctly placed and locked.  
 • For use in pollution degree 2 environment (only non-conductive pollution).  
 • Install in an IP54 compliant chassis.  
 • For use indoors in dry, well ventilated locations only (in a control cabinet, for example).  
 • Mount each power supply vertically such that the AC input is at the bottom and the DC output at the top.

**2** POWER SUPPLY (MEAN WELL)  
 • The L input is internally fused.  
 • The N input is not internally fused.  
 • The power supply units are UL508, TUV EN60950-1 approved.

MEAN WELL P/N	AEROTECH P/N	MAX AMBIENT TEMPERATURE	INTERNAL FUSE ("L")
NDR-240-24	ECZ02954	50°C	5.0 A
NDR-240-48	ECZ02966	50°C	5.0 A

**3** AC INPUT POWER REQUIREMENTS

PI/N	DESCRIPTION	WIRE SIZE (min)
AC1 (L)	AC Power	0.8 mm <sup>2</sup> (#18 AWG); 300 V
AC2 (N)	AC Power	0.8 mm <sup>2</sup> (#18 AWG); 300 V
⊕	Protective Ground	0.8 mm <sup>2</sup> (#18 AWG); 300 V

NOTE: The user must provide 10 A, 250 VAC fuse(s) or Circuit Breaker(s) to protect the AC inputs.

**4** All twisted wires must be twisted at least 2 turns/inch.  
**5** Terminate all connections with wire ferrules where possible.  
**6** System wiring is shown with a neutral line configuration. If applied A.C. does not contain a neutral, neutral line "N" must be correctly fused by the user.  
**7** DIN RAIL SPECIFICATIONS (Aerotech P/N: EAM00914)  
 • DIN Rail Dimensions - Millimeters [Inches]

	1-Axis	2-Axis
	313 [12.3]	386 [15.2]

• The DIN Rail should be cut such that one complete mounting hole extends beyond the components on each end.  
 • Use #10-32 (or equivalent) screws.  
 Use the DIN Rail Clip Kit (Aerotech P/N: XC2-DIN or XC2e-DIN) to mount the clip to the drive and then the drive to the DIN Rail.

**8** Terminal Block Selection Chart

Terminal Block	Description
TB1	4-Position Terminal Block: GROUND (Aerotech P/N: ECK01530)
TB2, TB3	4-Position Terminal Block: POWER (Aerotech P/N: ECK01529)
TB3	Terminal Block Cover: FOR TB3 (L1) (Aerotech P/N: ECK01533)
TB4, TB5, TB6	2-Position Terminal Block: GROUND (Aerotech P/N: ECK01402)
n/a	End Barrier Clamp (Aerotech P/N: ECK01404)

The information on this page is for reference only.

Figure 1-11: Automation1-PS2-D1-P2-AX02

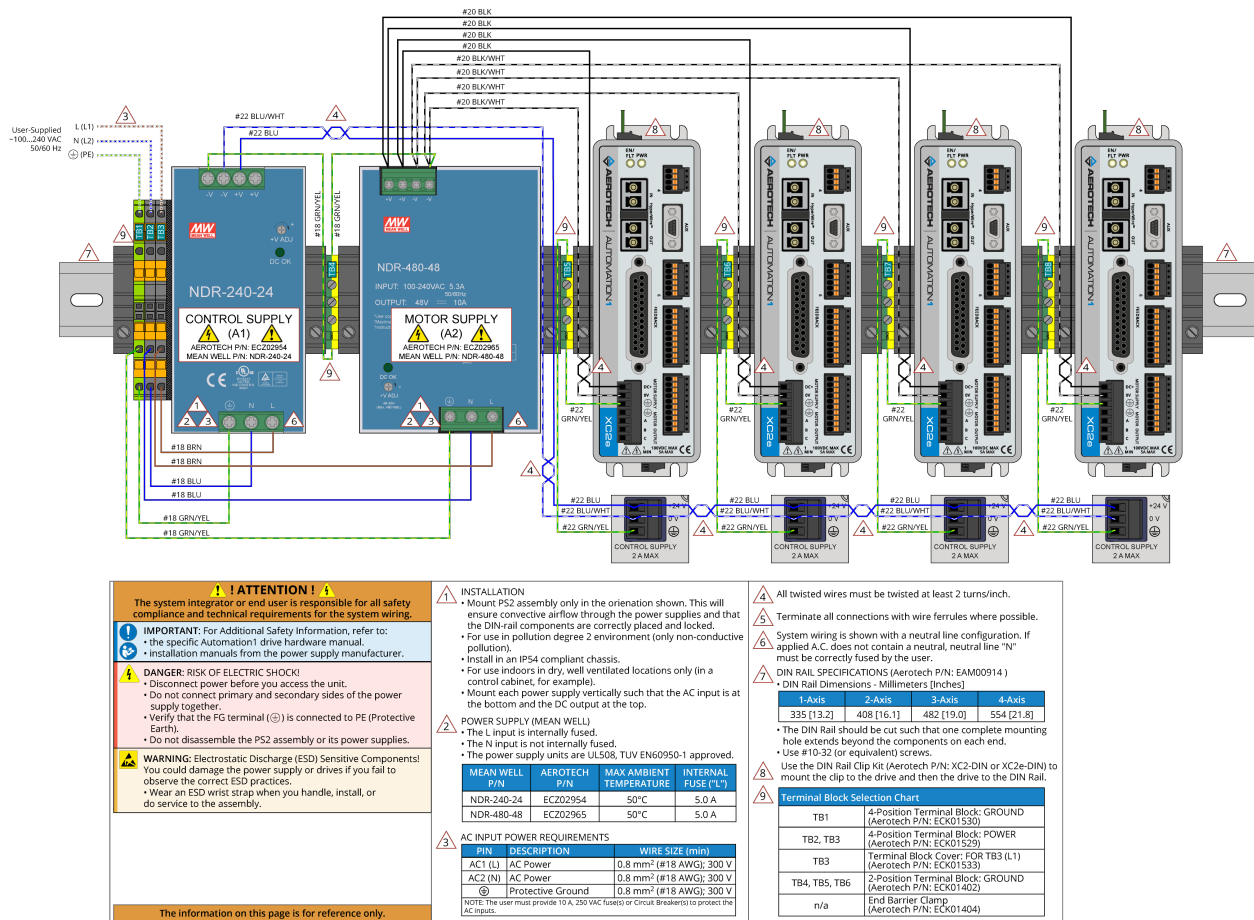
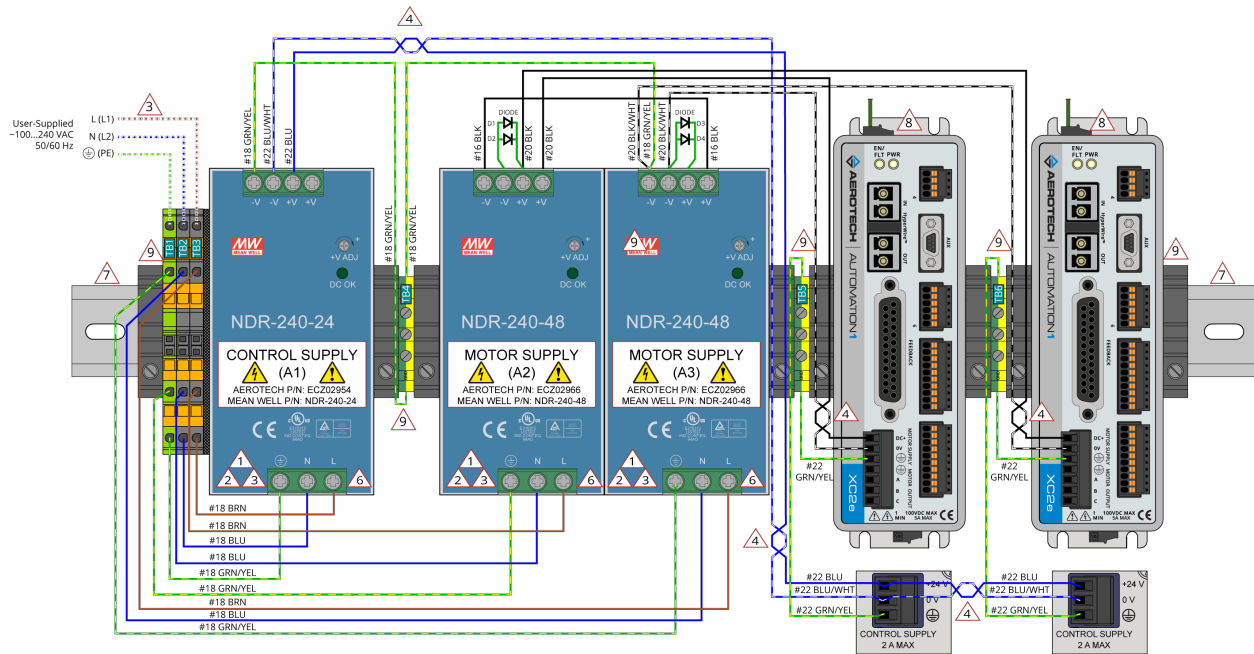

Figure 1-12: Automation1-PS2-D1-P3-AX04



**! ! ATTENTION ! !**  
The system integrator or end user is responsible for all safety compliance and technical requirements for the system wiring.

**IMPORTANT:** For Additional Safety Information, refer to:  
 • the specific Automation1 drive hardware manual.  
 • installation manuals from the power supply manufacturer.

**DANGER: RISK OF ELECTRIC SHOCK!**  
 • Disconnect power before you access the unit.  
 • Do not connect primary and secondary sides of the power supply together.  
 • Verify that the FG terminal (⊕) is connected to PE (Protective Earth).  
 • Do not disassemble the PS2 assembly or its power supplies.

**WARNING:** Electrostatic Discharge (ESD) Sensitive Components! You could damage the power supply or drives if you fail to observe the correct ESD practices.  
 • Wear an ESD wrist strap when you handle, install, or do service to the assembly.

**INSTALLATION**

- Mount PS2 assembly only in the orientation shown. This will ensure convective airflow through the power supplies and that the DIN-rail components are correctly placed and locked.
- For use in pollution degree 2 environment (only non-conductive pollution).
- Install in an IP54 compliant chassis.
- For use indoors in dry, well ventilated locations only (in a control cabinet, for example).
- Mount each power supply vertically such that the AC input is at the bottom and the DC output at the top.

**POWER SUPPLY (MEAN WELL)**

- The L input is internally fused.
- The N input is not internally fused.
- The power supply units are UL508, TUV EN60950-1 approved.

MEAN WELL P/N	AEROTECH P/N	MAX AMBIENT TEMPERATURE	INTERNAL FUSE ("I")
NDR-240-24	ECZ02954	50°C	5.0 A
NDR-240-48	ECZ02966	50°C	5.0 A

**AC INPUT POWER REQUIREMENTS**

PIN	DESCRIPTION	WIRE SIZE (min)
AC1 (L)	AC Power	0.8 mm <sup>2</sup> (#18 AWG); 300 V
AC2 (N)	AC Power	0.8 mm <sup>2</sup> (#18 AWG); 300 V
⊕	Protective Ground	0.8 mm <sup>2</sup> (#18 AWG); 300 V

NOTE: The user must provide 10 A, 250 VAC fuse(s) or Circuit Breaker(s) to protect the AC inputs.

- All twisted wires must be twisted at least 2 turns/inch.
- Terminate all connections with wire ferrules where possible.
- System wiring is shown with a neutral line configuration. If applied A.C. does not contain a neutral, neutral line "N" must be correctly fused by the user.
- DIN RAIL SPECIFICATIONS (Aerotech P/N: EAM00914)
  - DIN Rail Dimensions - Millimeters [Inches]

	1-Axis	2-Axis
	376 [14.8]	446 [17.7]

  - The DIN Rail should be cut such that one complete mounting hole extends beyond the components on each end.
  - Use #10-32 (or equivalent) screws.
- Use the DIN Rail Clip Kit (Aerotech P/N: XC2-DIN or XC2e-DIN) to mount the clip to the drive and then the drive to the DIN Rail.

**Terminal Block Selection Chart**

Terminal Block	Description
TB1	4-Position Terminal Block: GROUND (Aerotech P/N: ECK01530)
TB2, TB3	4-Position Terminal Block: POWER (Aerotech P/N: ECK01529)
TB3	Terminal Block Cover: FOR TB3 (L1) (Aerotech P/N: ECK01533)
TB4, TB5, TB6	2-Position Terminal Block: GROUND (Aerotech P/N: ECK01402)
n/a	End Barrier Clamp (Aerotech P/N: ECK01404)

Figure 1-13: Automation1-PS2-D1-P4-AX02

## Chapter 3: Maintenance

The PS2 and external wiring should be inspected at least once per month. The inspection interval will depend on the environment and the use of the system.



**WARNING:** All service and maintenance must be performed by qualified personnel.



**WARNING:** Do not use of this product in a manner other than its intended use.



**WARNING: Electrostatic Discharge (ESD) Sensitive Components!**

You could damage the power supply or drives if you fail to observe the correct ESD practices.

Wear an ESD wrist strap when you handle, install, or do service to the PS2 assembly.

**Table 2-1: Preventative Maintenance**

Check	Action to be Taken
Visually inspect PS2 enclosure for loose or damaged parts / hardware. <b>Note:</b> Internal inspection is not required.	Parts should be repaired as required. If internal damage is suspected, these parts should be checked and repairs made if necessary.
Check for fluids or electrically conductive material exposure.	Any fluids or electrically conductive material must not be permitted to enter the PS2.
Visually inspect all cables and connections.	Tighten or re-secure any loose connections. Replace worn or frayed cables. Replace broken connectors.
Visually inspect the air ventilation openings of the power supplies and drives for obstructions (dust or debris).	Remove the obstruction from the ventilation opening.

### Cleaning

The PS2 enclosure can be wiped with a clean, dry, soft cloth. The cloth may be slightly moistened if required with water or isopropyl alcohol to aid in cleaning if necessary. In this case, be careful not to allow moisture to enter the PS2 or onto exposed connectors / components. Fluids and sprays are not recommended because of the chance for internal contamination, which may result in electrical shorts and/or corrosion. The electrical power must be disconnected from the PS2 while cleaning. Do not allow cleaning substances or other fluids to enter the PS2 or to get on to any of the connectors. Cleaning labels should be avoided to prevent removing label information.

*This page intentionally left blank.*



## Appendix A: Warranty and Field Service

Aerotech, Inc. warrants its products to be free from harmful defects caused by faulty materials or poor workmanship for a minimum period of one year from date of shipment from Aerotech. Aerotech's liability is limited to replacing, repairing or issuing credit, at its option, for any products that are returned by the original purchaser during the warranty period. Aerotech makes no warranty that its products are fit for the use or purpose to which they may be put by the buyer, whether or not such use or purpose has been disclosed to Aerotech in specifications or drawings previously or subsequently provided, or whether or not Aerotech's products are specifically designed and/or manufactured for buyer's use or purpose. Aerotech's liability on any claim for loss or damage arising out of the sale, resale, or use of any of its products shall in no event exceed the selling price of the unit.

THE EXPRESS WARRANTY SET FORTH HEREIN IS IN LIEU OF AND EXCLUDES ALL OTHER WARRANTIES, EXPRESSED OR IMPLIED, BY OPERATION OF LAW OR OTHERWISE. IN NO EVENT SHALL AEROTECH BE LIABLE FOR CONSEQUENTIAL OR SPECIAL DAMAGES.

### Return Products Procedure

Claims for shipment damage (evident or concealed) must be filed with the carrier by the buyer. Aerotech must be notified within thirty (30) days of shipment of incorrect material. No product may be returned, whether in warranty or out of warranty, without first obtaining approval from Aerotech. No credit will be given nor repairs made for products returned without such approval. A "Return Materials Authorization (RMA)" number must accompany any returned product(s). The RMA number may be obtained by calling an Aerotech service center or by submitting the appropriate request available on our website ([www.aerotech.com](http://www.aerotech.com)). Products must be returned, prepaid, to an Aerotech service center (no C.O.D. or Collect Freight accepted). The status of any product returned later than thirty (30) days after the issuance of a return authorization number will be subject to review.

Visit [Global Technical Support Portal](#) for the location of your nearest Aerotech Service center.

### Returned Product Warranty Determination

After Aerotech's examination, warranty or out-of-warranty status will be determined. If upon Aerotech's examination a warranted defect exists, then the product(s) will be repaired at no charge and shipped, prepaid, back to the buyer. If the buyer desires an expedited method of return, the product(s) will be shipped collect. Warranty repairs do not extend the original warranty period.

**Fixed Fee Repairs** - Products having fixed-fee pricing will require a valid purchase order or credit card particulars before any service work can begin.

**All Other Repairs** - After Aerotech's evaluation, the buyer shall be notified of the repair cost. At such time the buyer must issue a valid purchase order to cover the cost of the repair and freight, or authorize the product(s) to be shipped back as is, at the buyer's expense. Failure to obtain a purchase order number or approval within thirty (30) days of notification will result in the product(s) being returned as is, at the buyer's expense.

Repair work is warranted for ninety (90) days from date of shipment. Replacement components are warranted for one year from date of shipment.

### Rush Service

At times, the buyer may desire to expedite a repair. Regardless of warranty or out-of-warranty status, the buyer must issue a valid purchase order to cover the added rush service cost. Rush service is subject to Aerotech's approval.

### On-site Warranty Repair

If an Aerotech product cannot be made functional by telephone assistance or by sending and having the customer install replacement parts, and cannot be returned to the Aerotech service center for repair, and if Aerotech determines the problem could be warranty-related, then the following policy applies:

Aerotech will provide an on-site Field Service Representative in a reasonable amount of time, provided that the customer issues a valid purchase order to Aerotech covering all transportation and subsistence costs. For warranty field repairs, the customer will not be charged for the cost of labor and material. If service is rendered at times other than normal work periods, then special rates apply.

If during the on-site repair it is determined the problem is not warranty related, then the terms and conditions stated in the following "On-Site Non-Warranty Repair" section apply.

### On-site Non-Warranty Repair

If any Aerotech product cannot be made functional by telephone assistance or purchased replacement parts, and cannot be returned to the Aerotech service center for repair, then the following field service policy applies:

Aerotech will provide an on-site Field Service Representative in a reasonable amount of time, provided that the customer issues a valid purchase order to Aerotech covering all transportation and subsistence costs and the prevailing labor cost, including travel time, necessary to complete the repair.

### Service Locations

<http://www.aerotech.com/contact-sales.aspx?mapState=showMap>

#### **USA, CANADA, MEXICO**

Aerotech, Inc.  
Global Headquarters

#### **CHINA**

Aerotech China  
Full-Service Subsidiary

#### **GERMANY**

Aerotech Germany  
Full-Service Subsidiary

#### **TAIWAN**

Aerotech Taiwan  
Full-Service Subsidiary

#### **UNITED KINGDOM**

Aerotech United Kingdom  
Full-Service Subsidiary

## Appendix B: Revision History

Revision	Description
1.01	Update: <a href="#">EU Declaration of Conformity</a>
1.00	New manual

*This page intentionally left blank.*

**Index****P**

packing list	16
Pollution	15

**R**

Revision History	27
------------------	----

**S**

Safety Procedures and Warnings	7
serial number	16
Specifications	
Unit Weight	11
System part number	16

**T**

Table of Contents	3
-------------------	---

**U**

Unit Weight	11
Use	15

**W**

Warranty and Field Service	25
----------------------------	----

**2**

2011/65/EU	5
2014/35/EU	5

**A**

Altitude	15
Ambient Temperature	15

**C**

Check for fluids or electrically conductive material exposure	23
Cleaning	23
Continuous Output Current specifications	10
Customer order number	16

**D**

Declaration of Conformity	5
Dimensions	11
Drawing number	16

**E**

Enclosure	11
EU 2015/863	5

**H**

Humidity	15
----------	----

**I**

inspect all cables and connections	23
IP54 Compliant	11

**M**

Mounting and Cooling	11
Mounting Hardware	11
Mounting Orientation	11

**O**

Output Voltage specifications	10
-------------------------------	----

*This page intentionally left blank.*