

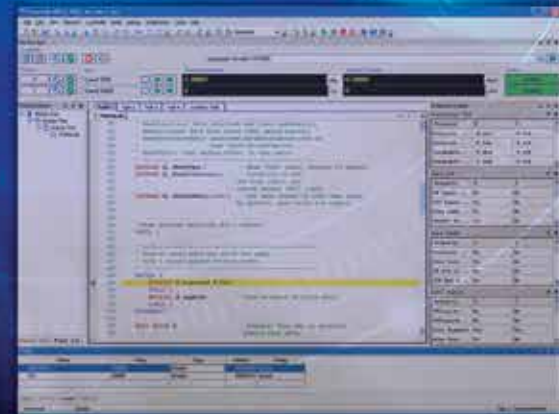

Integrated Motion and Machine Control Solutions



Aerotech's Advanced Automation Technologies: 46 years in the making... and going strong...



- Controls
- Software
- Amplifiers
- Motors
- PLC
- Fieldbus
- I/O
- Vision
- Peripherals
- Robotics
- Data Acquisition

WORLD HEADQUARTERS

Aerotech, Inc.
101 Zeta Drive, Pittsburgh, PA 15238
Ph: 412-963-7470
Email: sales@aerotech.com

Aerotech United Kingdom
The Old Brick Kiln, Ramsdell, Tadley
Hampshire RG26 5PR, UK
Ph: +44 (0)1256 855055
Email: sales@aerotech.co.uk

Aerotech Germany
Gustav-Weißkopf-Str. 18, 90768 Fürth, Germany
Ph: +49 (0)911 967 9370
Email: sales@aerotechgmbh.de

Aerotech Japan
WBG Marive East 22F, 2-6-1 Nakase
Mihama Ward, Chiba, Japan 261-7122
Ph: +81 (0)50 5830 6821
Email: sales@aerotechkk.co.jp

Aerotech China
Room 101, No. 28 Building, Tianlin Road 140
Xuhui District, Shanghai, China 200234
Ph: +86 (21) 6126 1058
Email: sales@aerotech.com

Aerotech Taiwan
5F, No 32, Aly 18, Lane 478, Ruiguang Rd
Neihu District, Taipei City, 114, Taiwan R.O.C.
Ph: +886 (0)2 8751 6690
Email: sales@aerotech.tw

Aerotech France
28300 Coltainville, France
Ph: +33 2 37 21 87 65
Email: cmonnier@aerotech.com

Aerotech Italy
20089 Rozzano (MI), Italy
Ph: +39 02 94759294

Copyright © 2017, Aerotech, Inc.
Information in this brochure is subject to change without notice.

Introduction

- 4 Aerotech Integrated Motion and Machine Control

Motion Composer Software

- 7 Setup and Configuration
- 9 Advanced Diagnostic and Tuning Capabilities
- 15 Integrated Development Environment and .NET
- 18 Integrated Automation: MotionPAC – PLC and Motion
- 32 Operator Interface
- 33 Software Architecture

Controller Architecture

- 34 Automation 3200 Digital Automation Platform
- 36 Ensemble Stand-Alone Multi-Axis Controller
- 38 Soloist Stand-Alone Single-Axis Controller
- 40 Controller and Drive Technology

Controller Features

- 48 Standard Control Capabilities
- 52 Advanced Control Capabilities
- 65 Fieldbus and Networking
- 66 Hexapod and Piezo Controls

Quick Reference

- 68 Controller Comparison Chart
- 72 Hardware Comparison Chart
- 74 Servomotors

Corporate Overview

- 81 Markets and Industries
- 88 Worldwide Training and Support
- 89 ISO Certification
- 90 Aerotech at a Glance

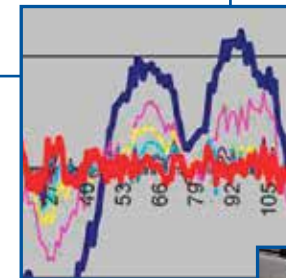
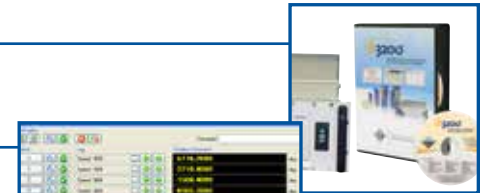

Configure Your Automation Solution with Aerotech

Common Software Platform: Tools, Powerful Programming Environment, Calculators, Diagnostics

Aerotech Integrated Motion and Machine Control

- High performance
- Easy to use
- Flexible
- Scalable
- Networked
- Lowest cost of ownership
- Advanced control technology
- Controls servo, piezo, voice coil, and stepper motor

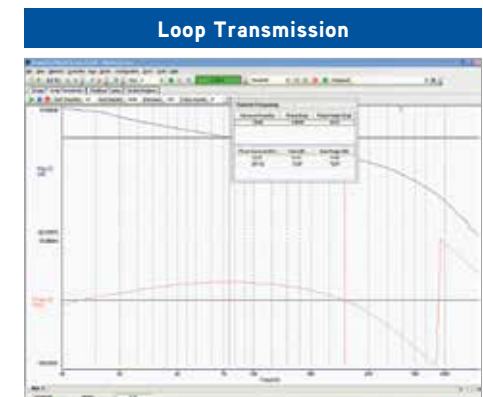
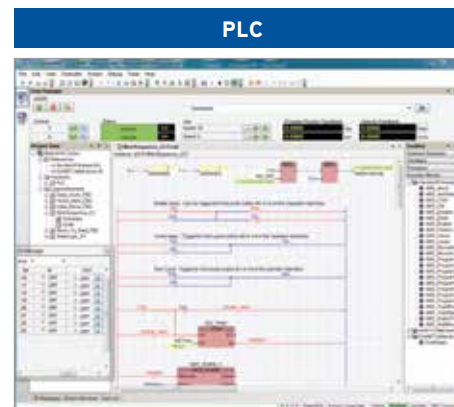
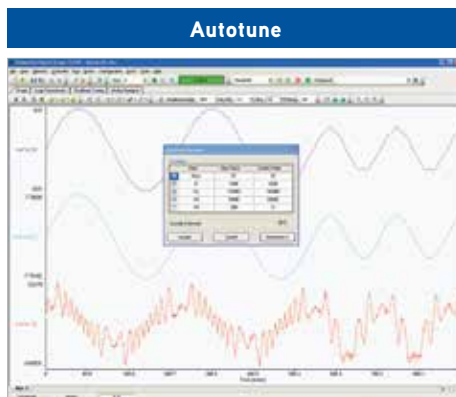
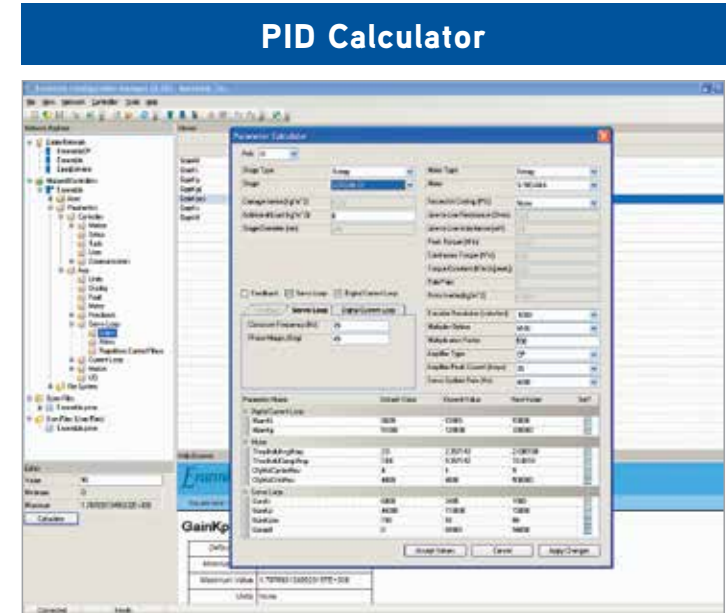
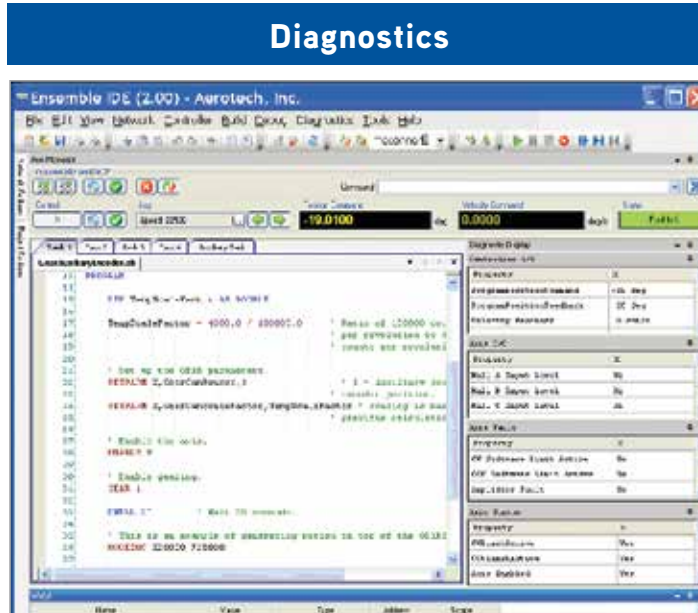

Develop your own applications with .NET, C#, VB.NET, C, LabVIEW®, Tango, AeroBasic™ or PLC languages

Award-Winning Controllers



Automation 3200

- PC-based
- 1 to 32 axes of coordinated motion
- Up to 32 tasks
- RS-274 (G-code)
- Advanced features for demanding applications
- PWM or linear drives (up to 150 A)
- Scanner control for marking
- Tightly integrated laser functionality
- Retro-fit package for old controls
- Integrated PLC and Motion - MotionPAC



Ensemble™

- Stand-alone
- 1 to 10 axis controller
- Up to 4 tasks
- Versatile, cost-effective, coordinated motion
- PWM or linear drives (10-150 A peak)
- Drives brushless, linear, rotary, DC brush or stepper motors
- Desktop, rack mount or panel mount



Soloist™

- Stand-alone
- Network up to 1024 single axes
- Up to 4 tasks
- Elegant, economical, versatile controller
- PWM or linear drives (10-150 A peak)
- Drives brushless, linear, rotary, DC brush or stepper motors



Piezo Controls

- Network up to 32
- Coordinated motion with servo and stepper motor stages
- Available in desktop or rackmount configuration
- Powered by Automation 3200 motion controller

Configure Your Automation Solution with Aerotech

Linear and Rotary Servomotors/Accessories



Fieldbus and Network Connectivity

- EtherNet/IP™
- PROFINET
- Modbus®/TCP
- RS-232
- EtherCAT™
- Ethernet TCP/IP
- USB
- GPIB

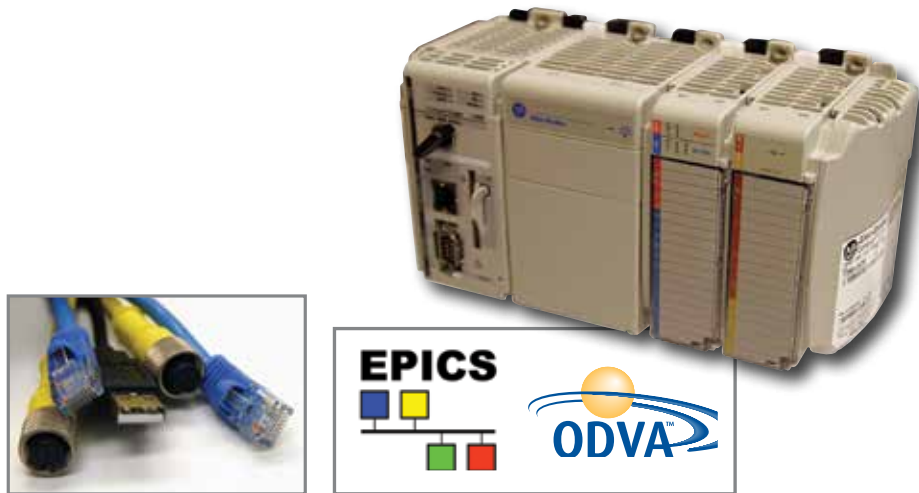

Custom Controls, Drives and Motors

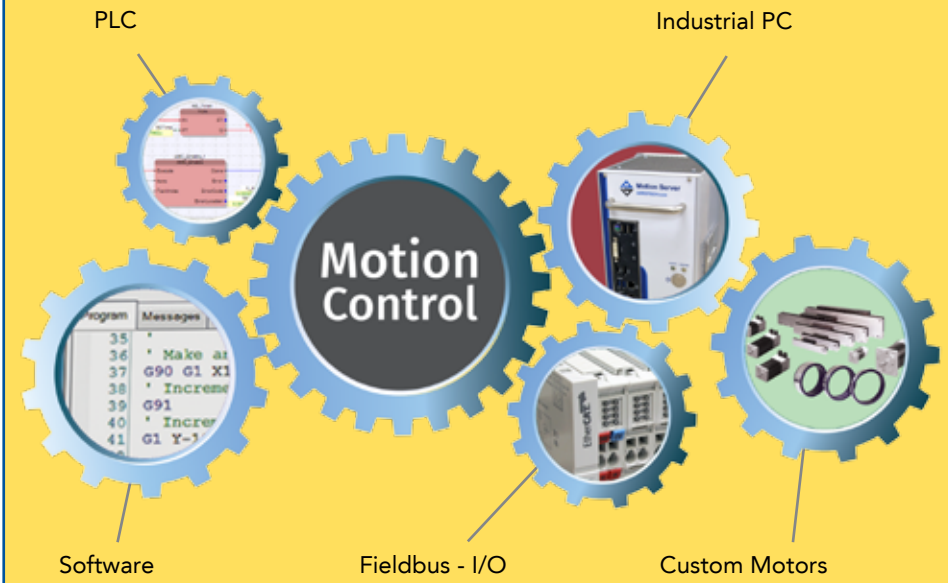

Scalable Automation Control Software for Simple Applications and the Power User

Integrated Configuration Manager for Easy Setup

Compare parameter files

Standard Windows® menus

See all the controllers on the network

Work with this controller

Network Explorer for project management

File space on the controller

Extensive calculators for system setup

Hyperlink to associated subjects

Context sensitive integrated help

Tool tips

Standard motion toolbars

Configurable workspace with your preferences

Name	X	Y	Z	U
DgMotType	3	3	3	0
DgMotCyclePer	4	4	4	4
DgMotCovRev	4000	4000	4000	1000
DgMotDistMag	0	0	0	0
DgMotSelSteps	1	1	1	1
DgMotSelInetSec	1000	10	10	10
DgMotStpperPec	4000	4000	4000	4000
DgMotStpperHighCur	2	2	2	2
DgMotStpperLowCur	1	1	1	1
DgMotStpperOGan	0	0	0	0
DgMotStpperVelVel	0	0	0	0

Mode	Motor Type
0	AC brushless with Hall effect switches
1	AC brushless without Hall effect switches ⁽¹⁾
2	DC brush

Motion Composer: Use the same Aerotech software with the A3200, Ensemble, or Soloist

- Configuration Manager to organize your applications
- Calculators for quick and easy setup
- Extensive diagnostics for commissioning
- Integrated Development Environment for fast development
- Data Acquisition and Analysis Tools for increasing performance
- Fully compliant .NET 2.0 shortens the development cycle

Scalable Automation Control Software for Simple Applications and the Power User

Calculators for Quick and Easy Setup

The screenshot shows the 'Parameter Calculator' window within a larger software environment. The window is divided into several sections:

- Axis Selection:** A dropdown menu at the top left is labeled 'Easily switch axis to be configured'.
- Motor Selection:** A dropdown menu for 'Motor Type' is labeled 'Select your motor or add a custom motor'. The selected motor is 'BMS60A'.
- Feedback Configuration:** Checkboxes for 'Feedback', 'Servo Loop', and 'Digital Current Loop' are present. A sub-window for 'Feedback' is open, showing 'Invert Direction' (No), 'Units' (deg), and 'Scale Factor' (1). This area is labeled 'Configure feedback for user units'.
- Parameter List:** A table at the bottom lists parameters with their current and new values. This area is labeled 'Summary of default, current and new values for all parameters'.
- Amplifier Type:** A dropdown menu for 'Amplifier Type' is labeled 'Select amplifier type'.
- Parameter Entry:** A text input field for 'Current Value' is labeled 'Directly enter any parameter values here'.

Annotations on the left side of the image include:

- 'Current loop calculator' pointing to the 'Digital Current Loop' checkbox.
- 'PID gain calculator' pointing to the 'Feedback' checkbox.

Parameter Name	Old Value	Current Value	New Value	Set?
Digital Current Loop				
IGainK	8600	8600	27000	<input type="checkbox"/>
IGainKp	51000	51000	62000	<input type="checkbox"/>
Motor				
ThresholdVrgAmp	2.6	2.6	2.367143	<input type="checkbox"/>
ThresholdClampAmp	10.6	10.6	9.367142	<input type="checkbox"/>
Servo Loop				
GainK	6000	600	3000	<input type="checkbox"/>
GainKp	44000	67000	140000	<input type="checkbox"/>

Extensive Diagnostics for all System Signals and Variables Shorten Debug and Startup Time

Control all axes at once

Multiple tabs for organized programming

System toolbar for system control

Axis toolbar for control of each axis

Standard toolbar for program control

Issue immediate commands without operator interface open

Dockable windows for custom work environment

Configurable to see only the information you want

Real-time readout of system state variables

Real-time access to system signals

Real-time reporting of all faults

Real-time system information

View task status as needed

Watch any variables as the program runs

Pop-up error reporting

Compiler output screen

The screenshot shows the Ensemble software interface. At the top, there are three toolbars: a system control toolbar, an axis control toolbar, and a standard program control toolbar. Below these is a control panel for axes X, Y, Z, and U, each with speed and position command fields. A central window displays the 'Ensemble' logo. To the right, several diagnostic windows are docked, showing real-time data for 'Axis I/O', 'Axis I/O', 'Axis Fault', and 'Axis Status'. At the bottom, there is a task list window and a compiler output window. Red arrows point from text labels to these various interface elements.

Scalable Automation Control Software for Simple Applications and the Power User

Advanced Diagnostic and Tuning Capabilities Minimize Startup Time and Allow Easy Optimization of Motion

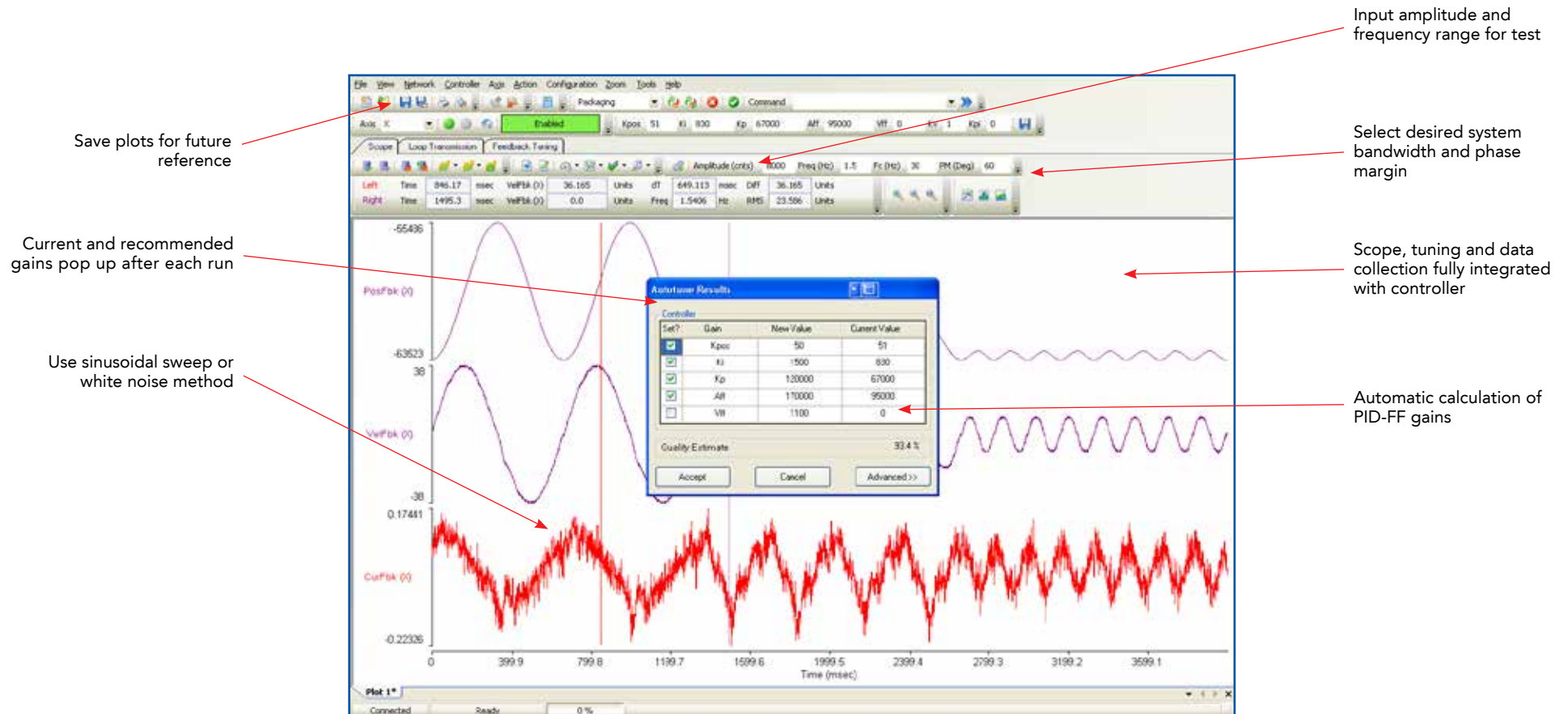

Use Encoder Tuning Tool to Increase System Accuracy

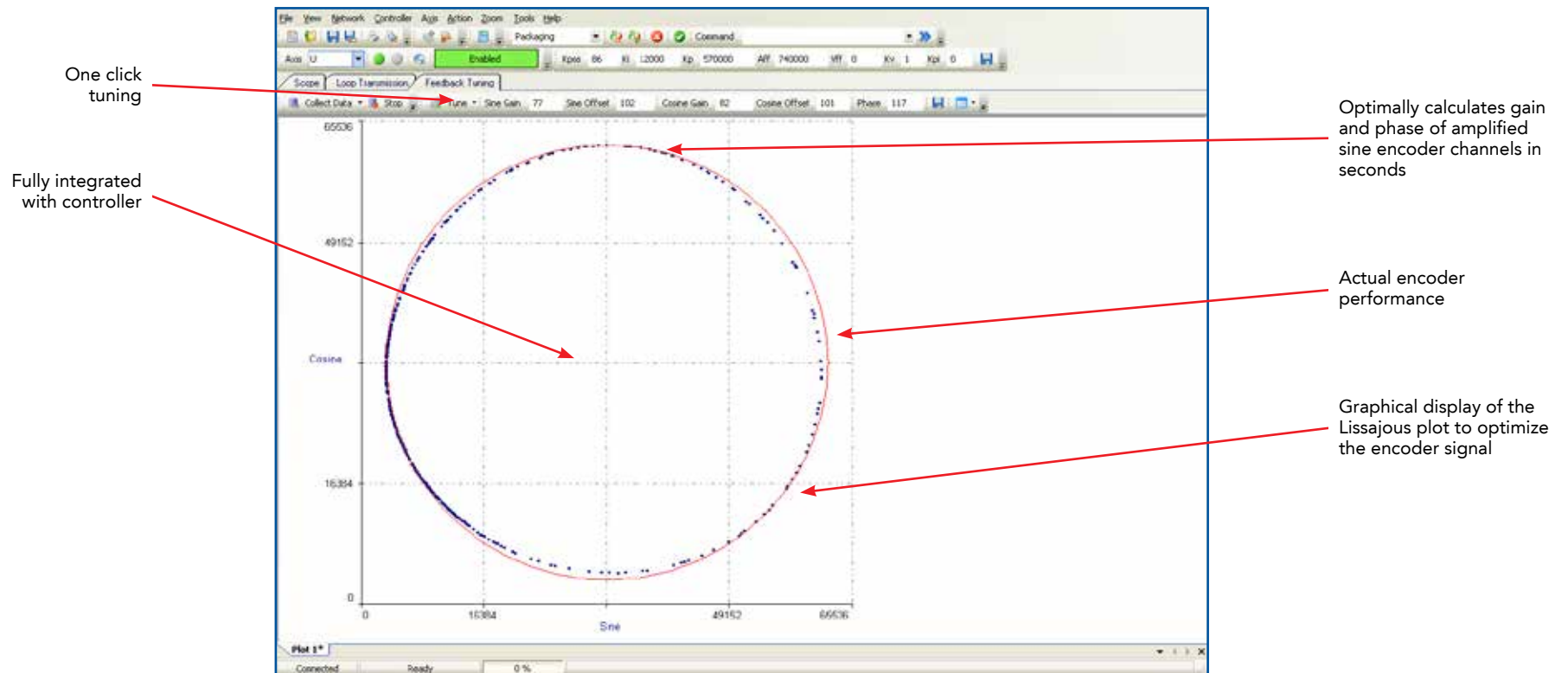

Scalable Automation Control Software for Simple Applications and the Power User

Loop Transmission is a Tuning and Diagnostic Utility that Greatly Enhances System Performance

Graphical loop shaping — add filters or change gain by dragging the gain curve, and the filter coefficients and PID gains are calculated automatically

Automatic calculation of gain margin

Identify resonances and use filters

Calculator and loop shaping to increase performance

Automatic calculation of phase margin

System frequency response or Bode plot

Open or closed loop response

Analyze position loop, velocity loop or current loop

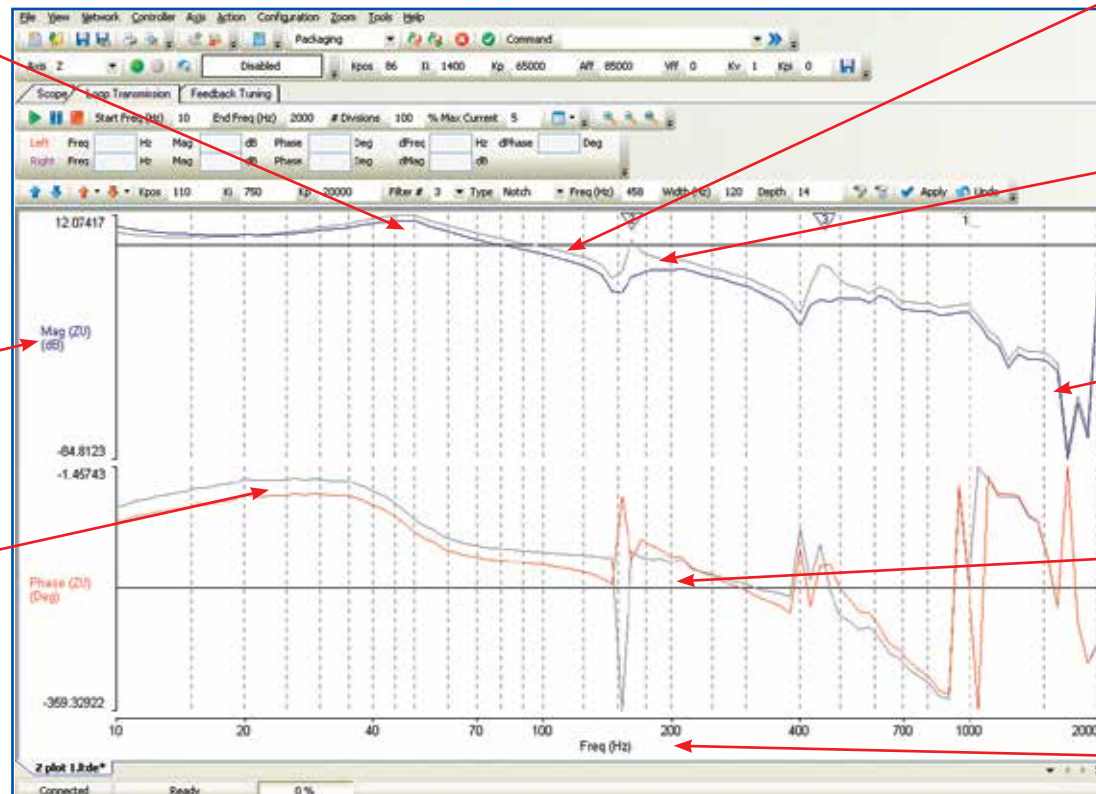

Fully Integrated Digital Filter Calculator Makes Performance Enhancements Easy

Select your filter type: low pass, high pass, notch, resonant, lead/lag

Axis selection

Configure filters for your application by specifying frequency, depth and width

Add up to eight filters per axis

Discrete time gains are automatically calculated and stored in the parameter file

Cursor control to read out gain and phase

Composite frequency response of all filters

Store all parameters in the parameter file

The screenshot shows the 'Digital Filter Calculator' window. At the top, there's a title bar and a close button. Below it, an 'Axis' dropdown menu is set to 'X'. The main area is divided into four columns for Filter 1, 2, 3, and 4. Each column has a 'Filter Type' dropdown, a 'Parameters' section with input fields, and a 'Coefficients' table. Filter 1 is 'LowPass' with a Cutoff Freq of 1000. Filter 2 is 'Notch' with Center Freq 1000, Width 50, and Depth 40. Filter 3 is 'Resonant' with Center Freq 100, Width 50, and Gain 20. Filter 4 is 'None'. Below the filters, there are readouts for 'Left' and 'Right' side parameters: Left (Freq 146.17 Hz, Mag 1.41 dB, Phase -40.67 Deg) and Right (Freq 1079.7 Hz, Mag -7.38 dB, Phase -110.93 Deg). At the bottom, there are buttons for 'Remove', 'Accept', 'Cancel', and 'Apply'. A graph at the bottom shows Magnitude (dB) and Phase (deg) vs Frequency (Hz) with a cursor at 999.95 Hz.

N0	0.226153999567032
N1	0.452306985855103
N2	0.226153999567032
D1	-0.280945986509323
D2	0.185561001300812

N0	0.980937453794024
N1	-2.17769114479404E-16
N2	0.98052351650469
D1	-2.17769114479404E-16
D2	0.961489805644493

N0	1.03435124810207
N1	-1.96783705291467
N2	0.958015141262473
D1	-1.96783705291467
D2	0.992366389309541

N0	1
N1	0
N2	0
D1	0
D2	0

Scalable Automation Control Software for Simple Applications and the Power User

Integrated I/O Panel for Debug, Commissioning or Operations

The screenshot displays the software's I/O panel, which is divided into several functional areas:

- Control Panel:** Features jog buttons for X, Y, Z, and U axes, each with a speed setting of 3600. It also displays position and velocity commands for each axis.
- Network Explorer:** A tree view on the left showing the project structure, including network, mapped controllers, and computer files.
- Digital I/O:** A central table for monitoring and controlling digital signals across three ports (Pot 0, Pot 1, Pot 2). Each port has 8 channels (IN and OUT) with status indicators (OFF/ON) and control buttons. A tooltip for '1B262 Pin 3' is visible over one of the channels.
- Analog I/O:** A section at the bottom for monitoring and setting analog signals for Channel 0 and Channel 1, showing IN and OUT voltage levels and setpoint controls.
- Diagnostic Display:** A panel on the right showing various system status indicators, including position feedback, program position, and axis fault status.

Annotations with red arrows point to specific features:

- View I/O axis information and program at the same time:** Points to the top control and command display area.
- Monitor digital I/O control:** Points to the Digital I/O table.
- Monitor analog I/O:** Points to the Analog I/O section.
- Set digital I/O during test and commissioning:** Points to the control buttons in the Digital I/O table.
- Use the I/O panel during programming to test as you go:** Points to the overall I/O panel area.
- Tool tip provides physical connector and pin on the drive to easily associate electrical wiring with software variables:** Points to the tooltip for '1B262 Pin 3'.
- Set analog I/O during commissioning for easy testing:** Points to the setpoint controls in the Analog I/O section.

Integrated Development Environment Shortens Development Time

Hide the axis manager while programming to see more code

Visual Studio®-like project management for advanced programming

Powerful IntelliSense® capability

Insert breakpoints to debug program

Low learning curve with strict implementation of .NET naming conventions

Detailed error explanation in error list

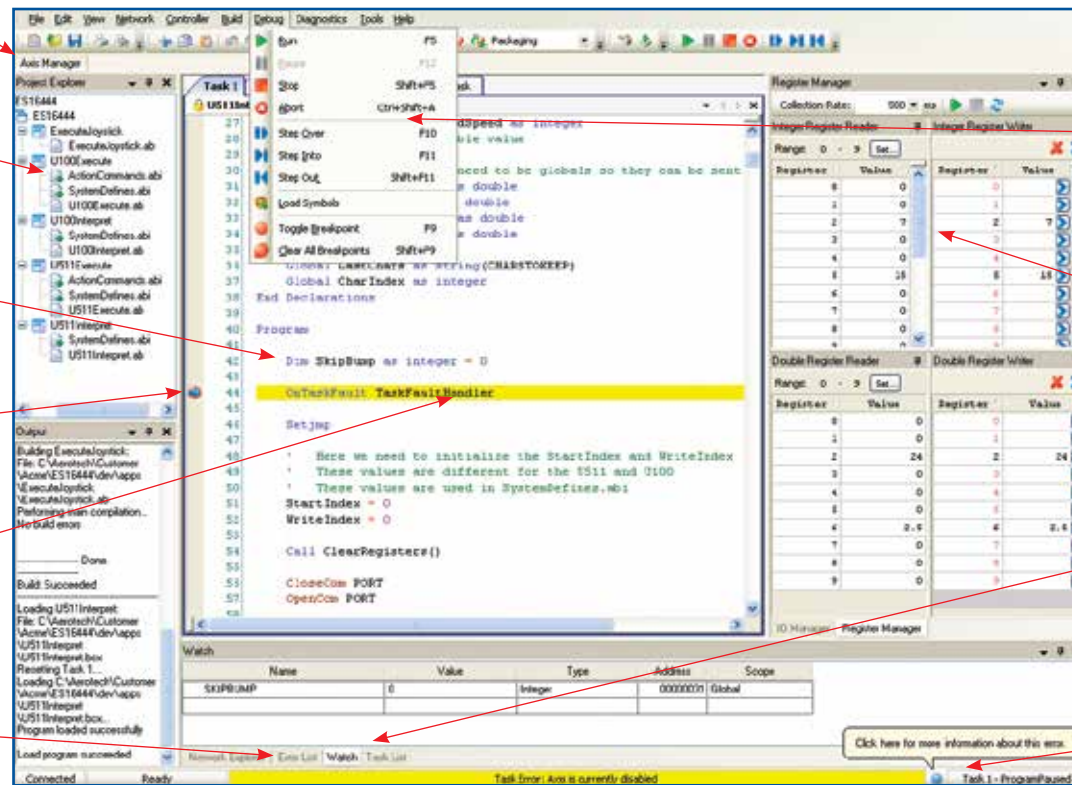

Minimize development time with debug features, break point, step in and step over

Full diagnostic instrumentation while debugging

Watch window shows variable values for easy debugging

Link to help file for description of error

Scalable Automation Control Software for Simple Applications and the Power User

Create Reusable Modules with AeroBasic™

Create reusable code with libraries and #include files

Write easy-to-read and maintainable code by using #define (rather than numeric constants)

```
1  Header
2  Include "DisplayLibrary.sbi"
3  Include "PartsLibrary.sbi"
4
5
6  Define QUIT_PARTS_PROGRAM  -1
7  Define ADD_NEW_PART        0
8  Define MAKE_PART           1
9
10 End Header
11
12 Program
13
14 Dim PartID      as Integer
15 Dim PartCount  as Integer
16 Dim UserAction as Integer
17 Dim PartsMade  as Integer
18
19 'If the user selects to quit from the display then negative one is returned.
20 while UserAction <> QUIT_PARTS_PROGRAM
21   UserAction = GetDisplayAction()
22
23   if UserAction = ADD_NEW_PART then
24     'User has selected to enter new part information.
25     Call AddNewDefinedPart()
26
27
28   elseif UserAction = MAKE_PART then
29
30     'First get the ID of the part they would like to make
31     PartID = GetPartID()
32     'Get the number of parts they would like to make
33     PartCount = GetPartCount()
34     'Call the function to actually make the parts
35     PartsMade = MakeParts(PartCount, PartID)
36     'Show the parts count on the display
37     Call DisplayPartCount(PartsMade)
38
39
40
41
42
43
44
45
46
47
48
49
50
51
52
53
54
55
56
57
58
59
60
61
62
63
64
65
66
67
68
69
70
71
72
73
74
75
76
77
78
79
80
81
82
83
84
85
86
87
88
89
90
91
92
93
94
95
96
97
98
99
100
101
102
103
104
105
106
107
108
109
110
111
112
113
114
115
116
117
118
119
120
121
122
123
124
125
126
127
128
129
130
131
132
133
134
135
136
137
138
139
140
141
142
143
144
145
146
147
148
149
150
151
152
153
154
155
156
157
158
159
160
161
162
163
164
165
166
167
168
169
170
171
172
173
174
175
176
177
178
179
180
181
182
183
184
185
186
187
188
189
190
191
192
193
194
195
196
197
198
199
200
201
202
203
204
205
206
207
208
209
210
211
212
213
214
215
216
217
218
219
220
221
222
223
224
225
226
227
228
229
230
231
232
233
234
235
236
237
238
239
240
241
242
243
244
245
246
247
248
249
250
251
252
253
254
255
256
257
258
259
260
261
262
263
264
265
266
267
268
269
270
271
272
273
274
275
276
277
278
279
280
281
282
283
284
285
286
287
288
289
290
291
292
293
294
295
296
297
298
299
300
301
302
303
304
305
306
307
308
309
310
311
312
313
314
315
316
317
318
319
320
321
322
323
324
325
326
327
328
329
330
331
332
333
334
335
336
337
338
339
340
341
342
343
344
345
346
347
348
349
350
351
352
353
354
355
356
357
358
359
360
361
362
363
364
365
366
367
368
369
370
371
372
373
374
375
376
377
378
379
380
381
382
383
384
385
386
387
388
389
390
391
392
393
394
395
396
397
398
399
400
401
402
403
404
405
406
407
408
409
410
411
412
413
414
415
416
417
418
419
420
421
422
423
424
425
426
427
428
429
430
431
432
433
434
435
436
437
438
439
440
441
442
443
444
445
446
447
448
449
450
451
452
453
454
455
456
457
458
459
460
461
462
463
464
465
466
467
468
469
470
471
472
473
474
475
476
477
478
479
480
481
482
483
484
485
486
487
488
489
490
491
492
493
494
495
496
497
498
499
500
501
502
503
504
505
506
507
508
509
510
511
512
513
514
515
516
517
518
519
520
521
522
523
524
525
526
527
528
529
530
531
532
533
534
535
536
537
538
539
540
541
542
543
544
545
546
547
548
549
550
551
552
553
554
555
556
557
558
559
560
561
562
563
564
565
566
567
568
569
570
571
572
573
574
575
576
577
578
579
580
581
582
583
584
585
586
587
588
589
590
591
592
593
594
595
596
597
598
599
600
601
602
603
604
605
606
607
608
609
610
611
612
613
614
615
616
617
618
619
620
621
622
623
624
625
626
627
628
629
630
631
632
633
634
635
636
637
638
639
640
641
642
643
644
645
646
647
648
649
650
651
652
653
654
655
656
657
658
659
660
661
662
663
664
665
666
667
668
669
670
671
672
673
674
675
676
677
678
679
680
681
682
683
684
685
686
687
688
689
690
691
692
693
694
695
696
697
698
699
700
701
702
703
704
705
706
707
708
709
710
711
712
713
714
715
716
717
718
719
720
721
722
723
724
725
726
727
728
729
730
731
732
733
734
735
736
737
738
739
740
741
742
743
744
745
746
747
748
749
750
751
752
753
754
755
756
757
758
759
760
761
762
763
764
765
766
767
768
769
770
771
772
773
774
775
776
777
778
779
780
781
782
783
784
785
786
787
788
789
790
791
792
793
794
795
796
797
798
799
800
801
802
803
804
805
806
807
808
809
810
811
812
813
814
815
816
817
818
819
820
821
822
823
824
825
826
827
828
829
830
831
832
833
834
835
836
837
838
839
840
841
842
843
844
845
846
847
848
849
850
851
852
853
854
855
856
857
858
859
860
861
862
863
864
865
866
867
868
869
870
871
872
873
874
875
876
877
878
879
880
881
882
883
884
885
886
887
888
889
890
891
892
893
894
895
896
897
898
899
900
901
902
903
904
905
906
907
908
909
910
911
912
913
914
915
916
917
918
919
920
921
922
923
924
925
926
927
928
929
930
931
932
933
934
935
936
937
938
939
940
941
942
943
944
945
946
947
948
949
950
951
952
953
954
955
956
957
958
959
960
961
962
963
964
965
966
967
968
969
970
971
972
973
974
975
976
977
978
979
980
981
982
983
984
985
986
987
988
989
990
991
992
993
994
995
996
997
998
999
1000
1001
1002
1003
1004
1005
1006
1007
1008
1009
1010
1011
1012
1013
1014
1015
1016
1017
1018
1019
1020
1021
1022
1023
1024
1025
1026
1027
1028
1029
1030
1031
1032
1033
1034
1035
1036
1037
1038
1039
1040
1041
1042
1043
1044
1045
1046
1047
1048
1049
1050
1051
1052
1053
1054
1055
1056
1057
1058
1059
1060
1061
1062
1063
1064
1065
1066
1067
1068
1069
1070
1071
1072
1073
1074
1075
1076
1077
1078
1079
1080
1081
1082
1083
1084
1085
1086
1087
1088
1089
1090
1091
1092
1093
1094
1095
1096
1097
1098
1099
1100
1101
1102
1103
1104
1105
1106
1107
1108
1109
1110
1111
1112
1113
1114
1115
1116
1117
1118
1119
1120
1121
1122
1123
1124
1125
1126
1127
1128
1129
1130
1131
1132
1133
1134
1135
1136
1137
1138
1139
1140
1141
1142
1143
1144
1145
1146
1147
1148
1149
1150
1151
1152
1153
1154
1155
1156
1157
1158
1159
1160
1161
1162
1163
1164
1165
1166
1167
1168
1169
1170
1171
1172
1173
1174
1175
1176
1177
1178
1179
1180
1181
1182
1183
1184
1185
1186
1187
1188
1189
1190
1191
1192
1193
1194
1195
1196
1197
1198
1199
1200
1201
1202
1203
1204
1205
1206
1207
1208
1209
1210
1211
1212
1213
1214
1215
1216
1217
1218
1219
1220
1221
1222
1223
1224
1225
1226
1227
1228
1229
1230
1231
1232
1233
1234
1235
1236
1237
1238
1239
1240
1241
1242
1243
1244
1245
1246
1247
1248
1249
1250
1251
1252
1253
1254
1255
1256
1257
1258
1259
1260
1261
1262
1263
1264
1265
1266
1267
1268
1269
1270
1271
1272
1273
1274
1275
1276
1277
1278
1279
1280
1281
1282
1283
1284
1285
1286
1287
1288
1289
1290
1291
1292
1293
1294
1295
1296
1297
1298
1299
1300
1301
1302
1303
1304
1305
1306
1307
1308
1309
1310
1311
1312
1313
1314
1315
1316
1317
1318
1319
1320
1321
1322
1323
1324
1325
1326
1327
1328
1329
1330
1331
1332
1333
1334
1335
1336
1337
1338
1339
1340
1341
1342
1343
1344
1345
1346
1347
1348
1349
1350
1351
1352
1353
1354
1355
1356
1357
1358
1359
1360
1361
1362
1363
1364
1365
1366
1367
1368
1369
1370
1371
1372
1373
1374
1375
1376
1377
1378
1379
1380
1381
1382
1383
1384
1385
1386
1387
1388
1389
1390
1391
1392
1393
1394
1395
1396
1397
1398
1399
1400
1401
1402
1403
1404
1405
1406
1407
1408
1409
1410
1411
1412
1413
1414
1415
1416
1417
1418
1419
1420
1421
1422
1423
1424
1425
1426
1427
1428
1429
1430
1431
1432
1433
1434
1435
1436
1437
1438
1439
1440
1441
1442
1443
1444
1445
1446
1447
1448
1449
1450
1451
1452
1453
1454
1455
1456
1457
1458
1459
1460
1461
1462
1463
1464
1465
1466
1467
1468
1469
1470
1471
1472
1473
1474
1475
1476
1477
1478
1479
1480
1481
1482
1483
1484
1485
1486
1487
1488
1489
1490
1491
1492
1493
1494
1495
1496
1497
1498
1499
1500
1501
1502
1503
1504
1505
1506
1507
1508
1509
1510
1511
1512
1513
1514
1515
1516
1517
1518
1519
1520
1521
1522
1523
1524
1525
1526
1527
1528
1529
1530
1531
1532
1533
1534
1535
1536
1537
1538
1539
1540
1541
1542
1543
1544
1545
1546
1547
1548
1549
1550
1551
1552
1553
1554
1555
1556
1557
1558
1559
1560
1561
1562
1563
1564
1565
1566
1567
1568
1569
1570
1571
1572
1573
1574
1575
1576
1577
1578
1579
1580
1581
1582
1583
1584
1585
1586
1587
1588
1589
1590
1591
1592
1593
1594
1595
1596
1597
1598
1599
1600
1601
1602
1603
1604
1605
1606
1607
1608
1609
1610
1611
1612
1613
1614
1615
1616
1617
1618
1619
1620
1621
1622
1623
1624
1625
1626
1627
1628
1629
1630
1631
1632
1633
1634
1635
1636
1637
1638
1639
1640
1641
1642
1643
1644
1645
1646
1647
1648
1649
1650
1651
1652
1653
1654
1655
1656
1657
1658
1659
1660
1661
1662
1663
1664
1665
1666
1667
1668
1669
1670
1671
1672
1673
1674
1675
1676
1677
1678
1679
1680
1681
1682
1683
1684
1685
1686
1687
1688
1689
1690
1691
1692
1693
1694
1695
1696
1697
1698
1699
1700
1701
1702
1703
1704
1705
1706
1707
1708
1709
1710
1711
1712
1713
1714
1715
1716
1717
1718
1719
1720
1721
1722
1723
1724
1725
1726
1727
1728
1729
1730
1731
1732
1733
1734
1735
1736
1737
1738
1739
1740
1741
1742
1743
1744
1745
1746
1747
1748
1749
1750
1751
1752
1753
1754
1755
1756
1757
1758
1759
1760
1761
1762
1763
1764
1765
1766
1767
1768
1769
1770
1771
1772
1773
1774
1775
1776
1777
1778
1779
1780
1781
1782
1783
1784
1785
1786
1787
1788
1789
1790
1791
1792
1793
1794
1795
1796
1797
1798
1799
1800
1801
1802
1803
1804
1805
1806
1807
1808
1809
1810
1811
1812
1813
1814
1815
1816
1817
1818
1819
1820
1821
1822
1823
1824
1825
1826
1827
1828
1829
1830
1831
1832
1833
1834
1835
1836
1837
1838
1839
1840
1841
1842
1843
1844
1845
1846
1847
1848
1849
1850
1851
1852
1853
1854
1855
1856
1857
1858
1859
1860
1861
1862
1863
1864
1865
1866
1867
1868
1869
1870
1871
1872
1873
1874
1875
1876
1877
1878
1879
1880
1881
1882
1883
1884
1885
1886
1887
1888
1889
1890
1891
1892
1893
1894
1895
1896
1897
1898
1899
1900
1901
1902
1903
1904
1905
1906
1907
1908
1909
1910
1911
1912
1913
1914
1915
1916
1917
1918
1919
1920
1921
1922
1923
1924
1925
1926
1927
1928
1929
1930
1931
1932
1933
1934
1935
1936
1937
1938
1939
1940
1941
1942
1943
1944
1945
1946
1947
1948
1949
1950
1951
1952
1953
1954
1955
1956
1957
1958
1959
1960
1961
1962
1963
1964
1965
1966
1967
1968
1969
1970
1971
1972
1973
1974
1975
1976
1977
1978
1979
1980
1981
1982
1983
1984
1985
1986
1987
1988
1989
1990
1991
1992
1993
1994
1995
1996
1997
1998
1999
2000
2001
2002
2003
2004
2005
2006
2007
2008
2009
2010
2011
2012
2013
2014
2015
2016
2017
2018
2019
2020
2021
2022
2023
2024
2025
2026
2027
2028
2029
2030
2031
2032
2033
2034
2035
2036
2037
2038
2039
2040
2041
2042
2043
2044
2045
2046
2047
2048
2049
2050
2051
2052
2053
2054
2055
2056
2057
2058
2059
2060
2061
2062
2063
2064
2065
2066
2067
2068
2069
2070
2071
2072
2073
2074
2075
2076
2077
2078
2079
2080
2081
2082
2083
2084
2085
2086
2087
2088
2089
2090
2091
2092
2093
2094
2095
2096
2097
2098
2099
2100
2101
2102
2103
2104
2105
2106
2107
2108
2109
2110
2111
2112
2113
2114
2115
2116
2117
2118
2119
2120
2121
2122
2123
2124
2125
2126
2127
2128
2129
2130
2131
2132
2133
2134
2135
2136
2137
2138
2139
2140
2141
2142
2143
2144
2145
2146
2147
2148
2149
2150
2151
2152
2153
2154
2155
2156
2157
2158
2159
2160
2161
2162
2163
2164
2165
2166
2167
2168
2169
2170
2171
2172
2173
2174
2175
2176
2177
2178
2179
2180
2181
2182
2183
2184
2185
2186
2187
2188
2189
2190
2191
2192
2193
2194
2195
2196
2197
2198
2199
2200
2201
2202
2203
2204
2205
2206
2207
2208
2209
2210
2211
2212
2213
2214
2215
2216
2217
2218
2219
2220
2221
2222
2223
2224
2225
2226
2227
2228
2229
2230
2231
2232
2233
2234
2235
2236
2237
2238
2239
2240
2241
2242
2243
2244
2245
2246
2247
2248
2249
2250
2251
2252
2253
2254
2255
2256
2257
2258
2259
2260
2261
2262
2263
2264
2265
2266
2267
2268
2269
2270
2271
2272
2273
2274
2275
2276
2277
2278
2279
2280
2281
2282
2283
2284
2285
2286
2287
2288
2289
2290
2291
2292
2293
2294
2295
2296
2297
2298
2299
2300
2301
2302
2303
2304
2305
2306
2307
2308
2309
2310
2311
2312
2313
2314
2315
2316
2317
2318
2319
2320
2321
2322
2323
2324
2325
2326
2327
2328
2329
2330
2331
2332
2333
2334
2335
2336
2337
2338
2339
2340
2341
2342
2343
2344
2345
2346
2347
2348
2349
2350
2351
2352
2353
2354
2355
2356
2357
2358
2359
2360
2361
2362
2363
2364
2365
2366
2367
2368
2369
2370
2371
2372
2373
2374
2375
2376
2377
2378
2379
2380
2381
2382
2383
2384
2385
2386
2387
2388
2389
2390
2391
2392
2393
2394
2395
2396
2397
2398
2399
2400
2401
2402
2403
2404
2405
2406
2407
2408
2409
2410
2411
2412
2413
2414
2415
2416
2417
2418
2419
2420
2421
2422
2423
2424
2425
2426
2427
2428
2429
2430
2431
2432
2433
2434
2435
2436
2437
2438
2439
2440
2441
2442
2443
2444
2445
2446
2447
2448
2449
2450
2451
2452
2453
2454
2455
2456
2457
2458
2459
2460
2461
2462
2463
2464
2465
2466
2467
2468
2469
2470
2471
2472
2473
2474
2475
2476
2477
2478
2479
2480
2481
2482
2483
2484
2485
2486
2487
2488
2489
2490
2491
2492
2493
2494
2495
2496
2497
2498
2499
2500
2501
2502
2503
2504
2505
2506
2507
2508
2509
2510
2511
2512
2513
2514
2515
2516
2517
2518
2519
2520
2521
2522
2523
2524
2525
2526
2527
2528
2529
2530
2531
2532
2533
2534
2535
2536
2537
2538
2539
2540
2541
2542
2543
2544
2545
2546
2547
2548
2549
2550
2551
2552
2553
2554
2555
2556
2557
2558
2559
2560
2561
2562
2563
2564
2565
2566
2567
2568
2569
2570
2571
2572
2573
2574
2575
2576
2577
2578
2579
2580
2581
2582
2583
2584
2585
2586
2587
2588
2589
2590
2591
2592
2593
2594
2595
2596
2597
2598
2599
2600
2601
2602
2603
2604
2605
2606
2
```

Create Easy to Maintain Code with AeroBasic™

User defined variable types allow an object-oriented approach to system design

Use structures to define your own data types

Advanced variable types such as arrays and strings allow for more advanced program design

```
1 Declarations
2 Structures to define a rectangular part with round corners
3 Type Part
4   ID as Integer
5   CornerRadius as Double
6   Width as Double
7   Length as Double
8 End Type
9 Global PartList(100) as Part
10 End Declarations
11
12 Function CutPart(Byref PartToCut as Part)
13   Home X Y
14   If PartToCut.CornerRadius = 0 then
15     Linear X PartToCut.Length F 100
16     Linear Y PartToCut.Width F 100
17     Linear X (-1)*PartToCut.Length F 100
18     Linear Y (-1)*PartToCut.Width F 100
19   else
20     Velocity On
21     Linear X PartToCut.Length F 100
22     CW X PartToCut.CornerRadius Y PartToCut.CornerRadius R PartToCut.CornerRadius
23     Linear Y PartToCut.Width F 100
24     CW X PartToCut.CornerRadius Y (-1)*PartToCut.CornerRadius R PartToCut.CornerRadius
25     Linear X (-1)*PartToCut.Length F 100
26     CW X (-1)*PartToCut.CornerRadius Y (-1)*PartToCut.CornerRadius R PartToCut.CornerRadius
27     Linear Y (-1)*PartToCut.Width F 100
28     Velocity Off
29     CW X (-1)*PartToCut.CornerRadius Y PartToCut.CornerRadius R PartToCut.CornerRadius
30   end if
31 End Function
32
33 Function MakeParts(Byval TotalParts as Integer, Byval PartID as Integer) as Integer
34   Dim PartIndexToMake as Integer = 0
35   Dim PartCount as Integer = 0
36
37   While PartID <> PartList(PartIndexToMake)
38     PartToCut = MakePart(PartID)
39     PartCount = PartCount + 1
40     PartIndexToMake = PartIndexToMake + 1
41   End While
42   Return PartCount
43 End Function
```

Memory management is done by the operating system

Keeping all motion code in one function creates modularity, which brings products to market faster and reduces maintenance cost

Variable initialization reduces code size and increases readability for multiple developers

Standard program flow: while/wend for/next repeat if/then/else

Integrated Automation: MotionPAC

Program in IEC 61131-3: LD, FBD, ST

- 30% to 50% reduction in development time
- High-performance motion fully integrated with standard PLC environment
- Easy-to-use diagnostics and tools
- Standards & Flexibility: IEC 61131-3, .NET, PLCopen, PC-based

The screenshot displays the MotionPAC software interface with several key components and annotations:

- Axis Manager:** Located at the top, it shows control status for axes Y and X, with 'Homed' and 'VH' indicators.
- Project View:** On the left, it shows a tree structure for 'MotionPAC Demo' including references, hardware, PLC, logical elements, and code.
- LD, FBD or ST programs:** The main workspace shows a ladder logic program with various motion control blocks like 'Enable Axes', 'Home Axis', 'Run Cycle', and 'M2 Timer'. Annotations point to these blocks, stating 'Combine LD and FBD in the same program' and 'Completely integrated motion blocks'.
- IO Manager:** At the bottom left, it shows a table for Axis Y with IN and OUT status for bits 16 through 23.
- Tag database:** On the right, a 'Function Blocks' list includes various motion control functions like 'AMC_Abort', 'AMC_AxisStatus', 'AMC_CW', etc.
- Online mode displays all Tag values:** A callout points to the 'Program Position Feedback' and 'Velocity Feedback' fields, which show numerical values like 0.0000.
- Axis manager:** A callout points to the 'Command' field and the 'Jog' controls.
- Standard LD:** A callout points to the overall ladder logic structure.

Integrated Automation: MotionPAC – PLC and Motion



HMI

- Program selection and run
- Jog panel
- Machine control
- Customizable buttons
- Axis manager



MotionPAC

- IEC 61131-3
- PLCopen
- Aerotech motion blocks
- Axis manager
- Extensive development & debug environment
- Simulate program

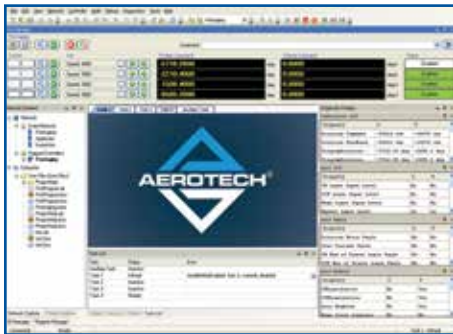

Motion Composer

- Axis manager
- Low-level motion diagnostics
- Motion programming
- Advanced control algorithms

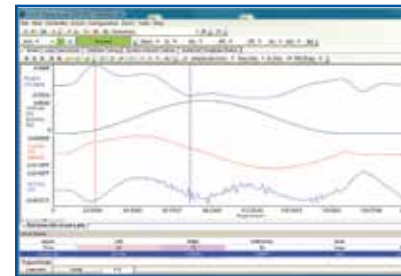

Scope

- Signal capture & analysis
- Autotuning
- Loop transmission
- Encoder tuning
- Advanced controls



Beckhoff Wago

- Data acquisition synchronized with motion & PLC
- High-speed registration
- Position Synchronized Output
- Machine interlocks
- Fieldbus I/O

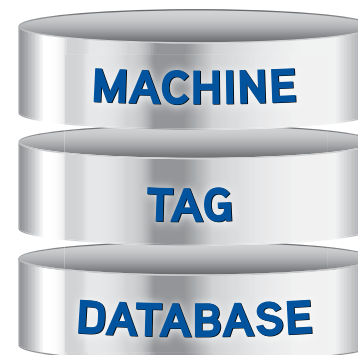

Central Machine Tag Database

- Tags available in all applications by name
- Define both local or global machine Tags
- Define Tags in I/O definition, ST, LD, FBD or motion program

Use Tags in Operator Interface by Name

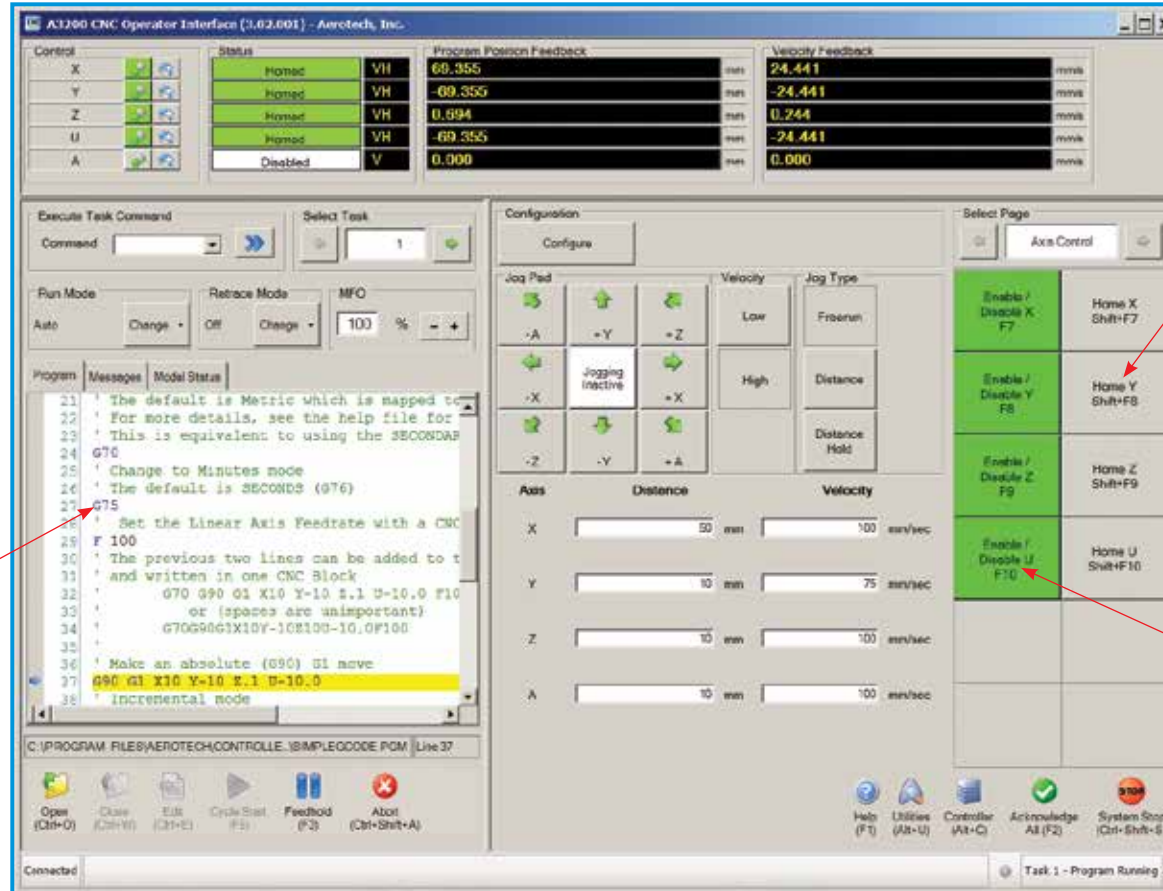

View CNC code running at same time as PLC code

Use shared Tags defined in MotionPAC by name in a button action

Use shared Tags by name in program called by a button click

Ladder Diagram

- VALUE
- TRUE
- FALSE
- COMMENT
- CONNECTOR
- JUMP
- LABEL
- RETURN
- CONTACT (NO, NC)
- COIL
- LEFT POWERRAIL
- RIGHT POWERRAIL

Function Blocks

- CTD
- CTU
- CTUD
- F_TRIG
- R_TRIG
- RS
- SR
- TOF
- TOF_R
- TON
- TON_R
- TP
- TP_R

Motion Blocks (Partial List)

- MoveAbsolute
- MoveRelative
- MoveSuperimposed
- MoveVelocity
- Home
- Stop
- PositionProfile
- MoveContinuous
- Halt
- CamIn/CamOut
- CamTableSelect
- GearInPos
- GearIn/GearOut
- Phasing

Administrative Motion Blocks (Partial List)

- ReadStatus
- ReadAxisError
- ReadParameter
- WriteParameter
- ReadActualPosition
- AbortTrigger
- ReadDigitalInput
- ReadDigitalOutput
- WriteDigitalOutput
- SetPosition

Functions (Partial List)

- ABS
- ACOS
- B_BCD_TO_DINT
- B_BCD_TO_INT
- DELETE
- DINT_TO_BOOL
- EXP
- EXPT
- FIND
- GE
- GE_STRING
- INT_TO_BOOL
- INT_TO_BYTE
- INT_TO_DINT
- INT_TO_DWORD
- LE
- LE_STRING
- LEFT
- LEN
- MULTIME
- NE
- OR
- REAL_TO_BOOL
- SEL_TO_BOOL
- SEL_TO_BYTE
- TRUNC_SINT
- UDINT_TO_BOOL

One I/O and Data Dictionary for the Machine

Integrated Development Environment Shortens Development Time

The screenshot displays the 'I/O Configuration' window. On the left, a tree view under 'PLC' shows 'IO Configure', 'Hardware', 'Configuration', 'eCLR', 'GlobalVariables', and 'LDSample1'. On the right, the 'Drive I/O' tab shows 'NDrive HPe' and 'NServo'. A table in the center maps PLC signals to Drive I/O signals. Below the table are two panels: 'Name' and 'I/O', each with columns for Name, Type, and I/O status. A status bar at the bottom indicates '16 bit(s) in 1 signal(s) selected'.

Annotations:

- Drive I/O connected to system
- Fieldbus I/O connected to the system
- I/O defined in one place
- I/O available in all applications: scope, configurator, MotionPAC (PLC) and Motion Composer
- Easily map I/O to program Tags
- Memory management automatically done by the MotionPAC

From	Signal	I/O	I/O	To	Signal	Type
PLC	eCLR.LDSample1.mfo	←	←	Drive I/O	HWIO\NServo\Signal5	WO...
PLC	eCLR.digOut	→	→	Drive I/O	HWIO\NServo\Signal3	BOOL

Name	Type	I/O
mfo	WORD	←

I/O	Name	Type
→	Signal3	BOOL
←	Signal4	INT
←	Signal5	WORD

Use Scope to Plot Any Motion, PLC, I/O, Variable or Tag

Motion variables

PLC Tags

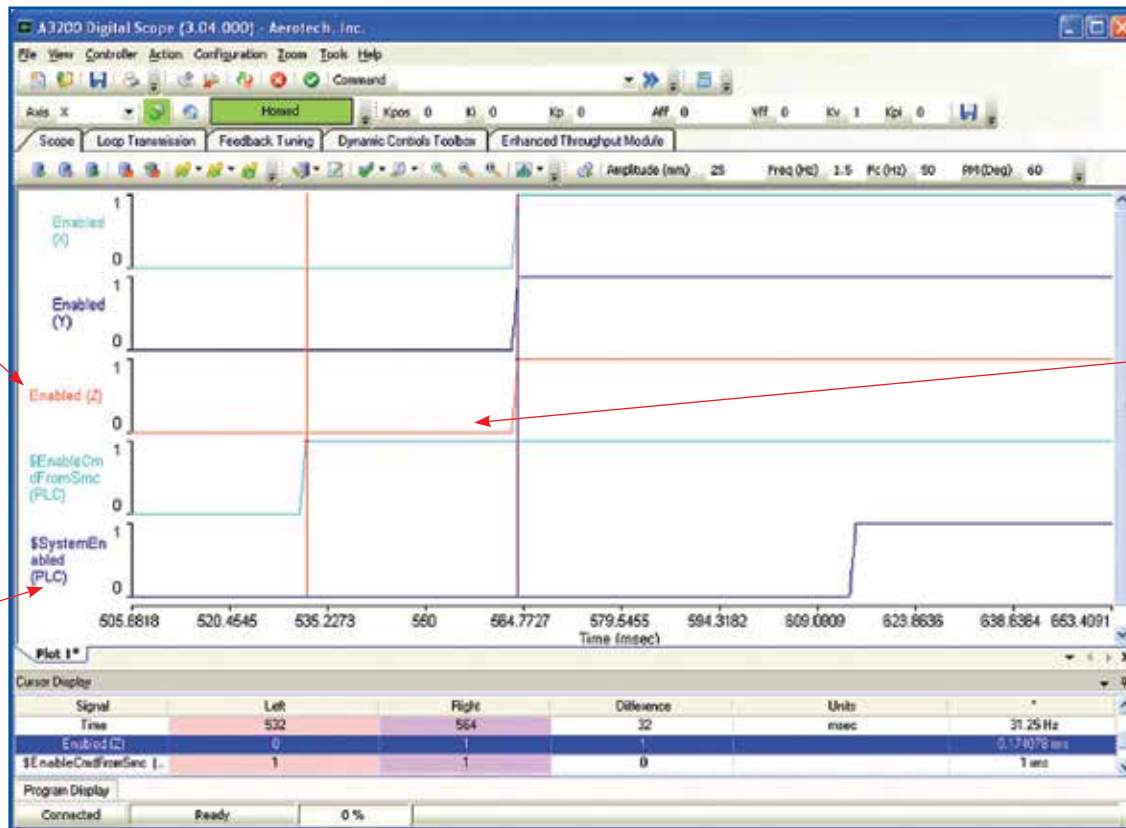

All information in Global Tag database available for real time plotting and analysis with all motion variables

SDK: Software Development Kit

Use the Aerotech standard GUI...
...or build a custom interface for your application

- Easy to use
- Faster development
- Lower maintenance cost

- C#
- VB.NET®
- Managed C++
- LabVIEW® (VIs provided)
- C Library
- EPICS

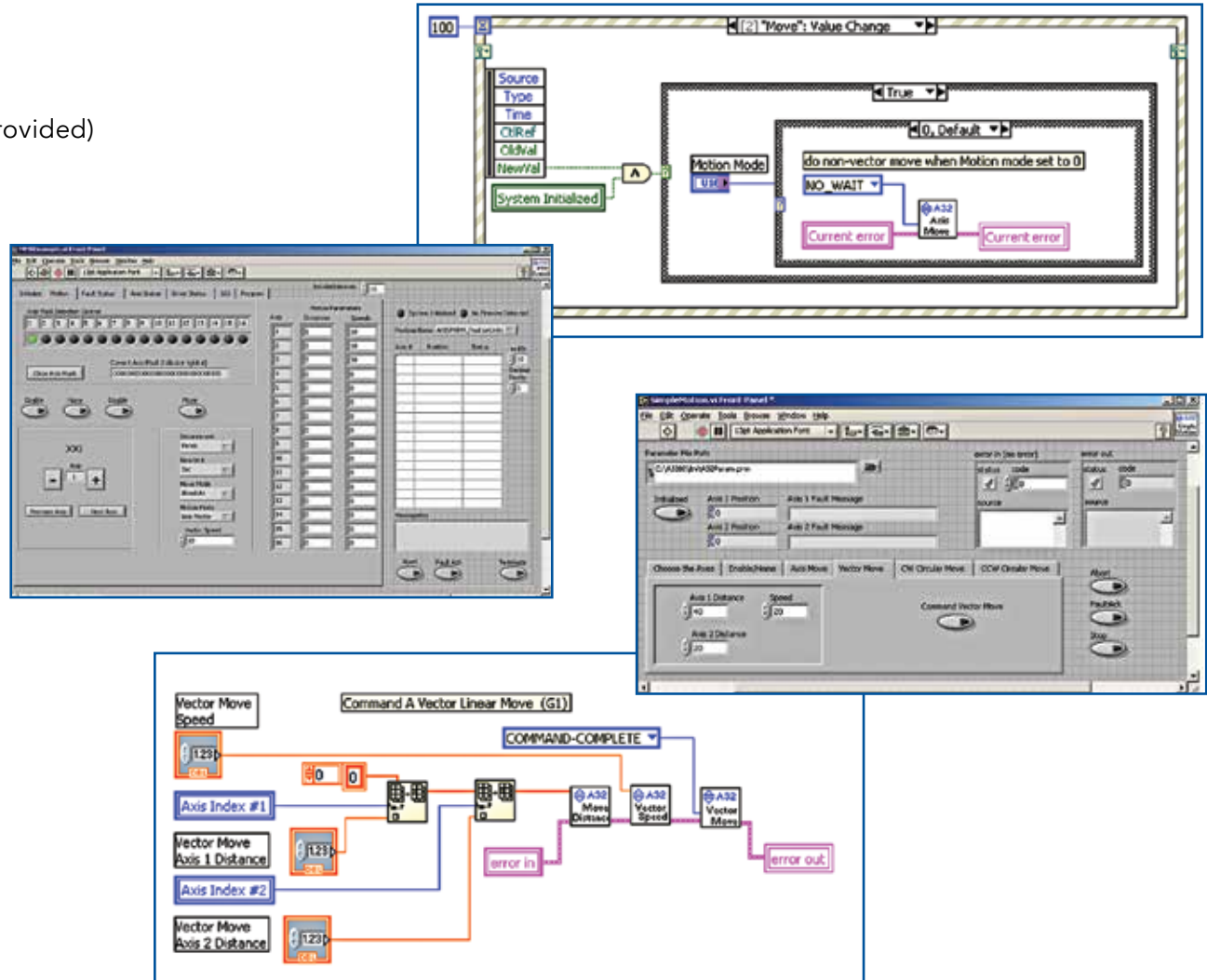

.NET Library

- High-end motion with a custom GUI
- Use the best language for the application
- Fully functional libraries for each language

All Aerotech applications are written using the .NET library. Aerotech provides customers with the same tools used at Aerotech.

TAKE ADVANTAGE OF:

.NET Framework 2.0

- Generics
- Enumerations
- Indexers
- Events
- Exceptions

Object Model

- Well-organized structure with two main classes: network and controllers
- Common features are higher in the hierarchy
- Minimal code required to accomplish the task at hand

Libraries Include:

- Initialization functions
- Global data functions
- Motion functions
- Error handling
- Status and position functions
- Analog and digital I/O functions
- Parameter functions
- Run CNC program functions
- Utility functions
- Get and set variable functions

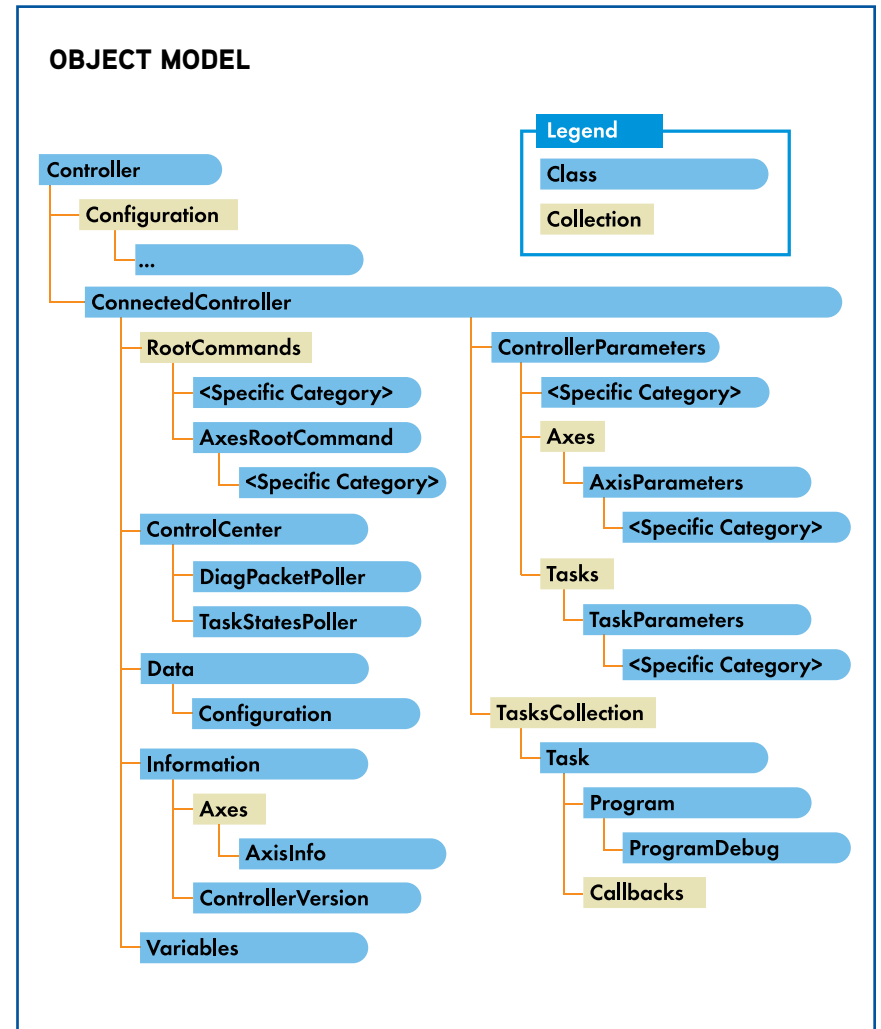

Motion Designer: Graphical Trajectory Generation and Data Analysis

- Minimize programming time
- Import actual data
- Import from Excel or MATLAB®

Applications

- Dynamic environment simulation
- Sensor or component testing
- Gyros or accelerometers; tracking or beam-steering gimbals
- Crash sensors and roll-over sensors

Create and modify multi-axis trajectories using predefined building blocks to provide rapid motion prototyping

Perform data analysis such as FFT, max, min, average, rms and standard deviation from an existing trajectory for diagnosing system performance

Add standard filter types: notch, resonant, low pass and high pass

Enter standard filter frequency parameters

Digital filter coefficients are automatically calculated

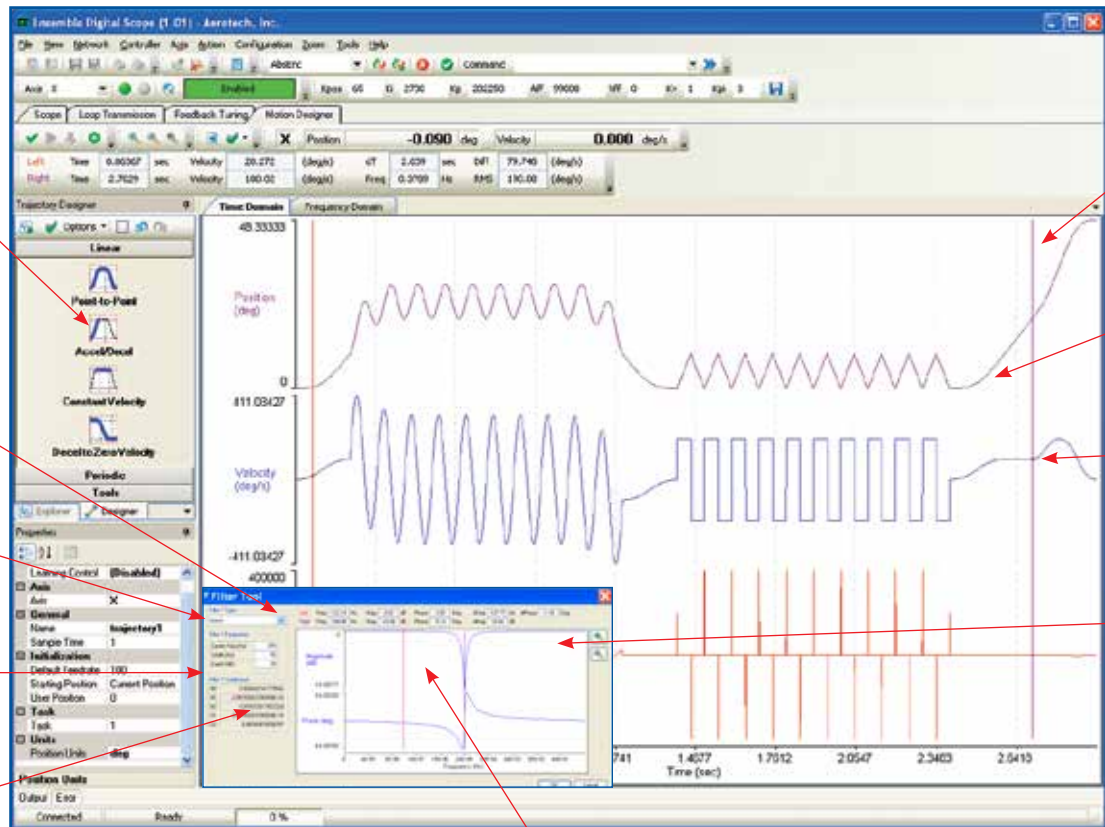

Cursor control

Apply filters to shape the trajectory frequency content

Import existing position, velocity or acceleration data

View the composite filter before applying to the trajectory

Cursor control

Automatic AeroBasic™ program generation for all controllers

Project tree for simple organization

Trajectory properties (e.g., user units)

Automatically calculates missing state information (e.g., acceleration, velocity or position)

Create periodic motion

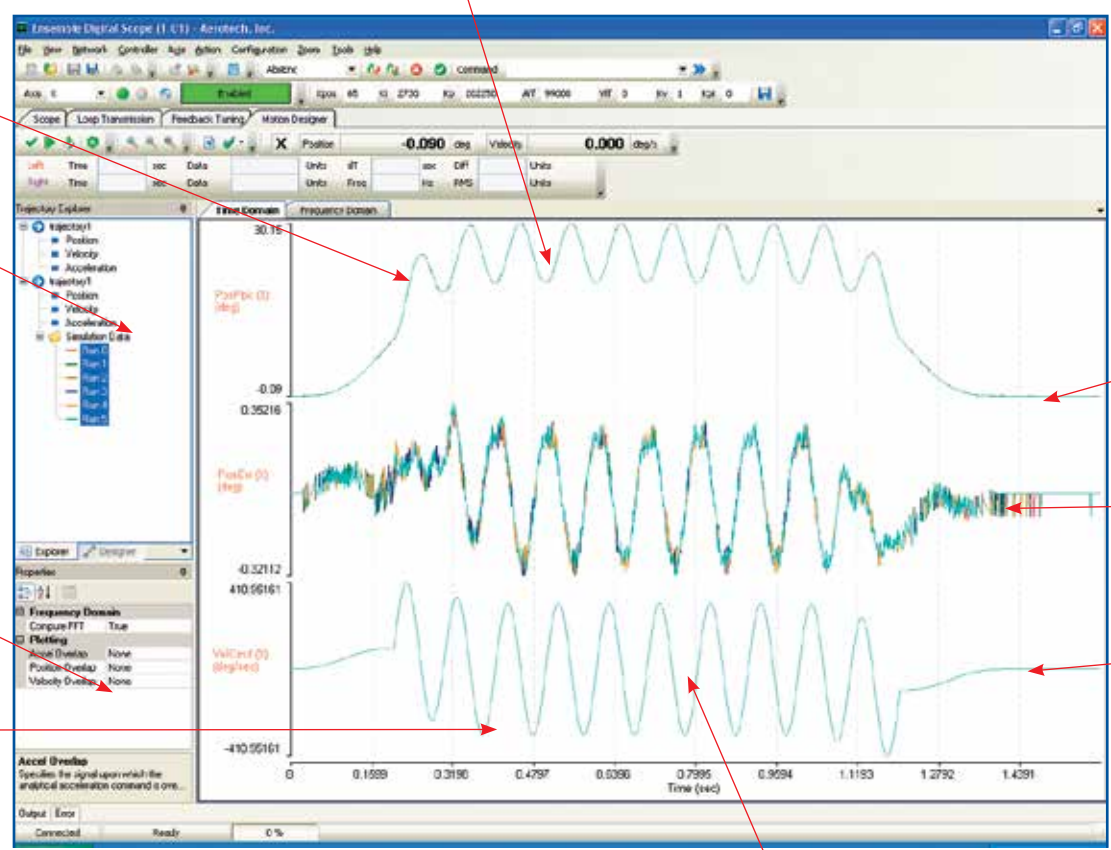

Point-to-point moves

Overlay multiple trials for easy comparison

Easily modify an existing trajectory

Rapid motion programming

- **Operate 1,2,3 axis motion simulators**
- **Frequency response mode allows input sine sweep and UUT performance tests on customer device**
- **Harmonic Cancellation optimizes motion position errors generated by sinusoidal motion**

Aerotech Motion Simulator – The Integrated, Easy to Use, Graphical Trajectory Generation, Data Analysis and Enhanced Machine Performance Toolkit

Aerotech's Motion Simulator software is an easy-to-use Windows®-based program for creating simple and advanced motion stimuli for testing and calibrating inertial sensors and systems. The Aerotech Motion Simulator software includes all controls for manually or automatically running 1-3 axis motion simulations. The GUI provides a user interface and programming environment that requires no third-party development software.

Key Features:

- User-friendly Windows®-based graphical user interface
- Trajectory tracking from Ethernet, analog or Windows® program inputs
- Iterative Learning minimizes position error
- Overlap multiple runs of a trajectory to easily see how program changes modify the motion
- Perform data analysis such as FFT, max, min, average, rms and standard deviation from an existing trajectory for diagnosing system performance
- Data input file formats include Excel, CSV or MATLAB®; Motion Simulator can calculate the missing state variables



Main Screen

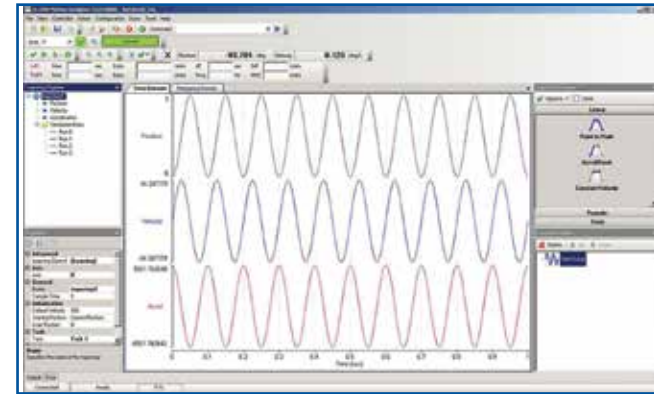

Motion Designer

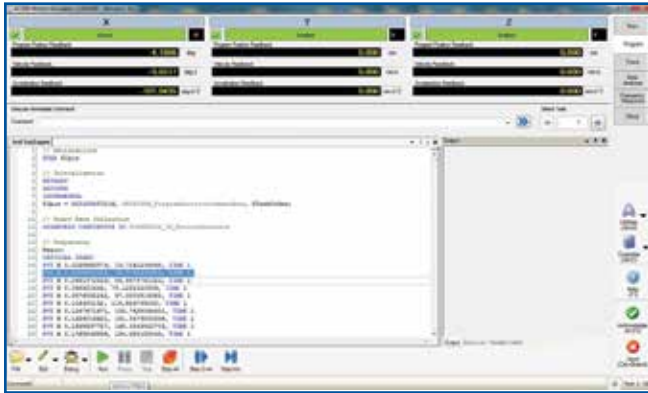

Program

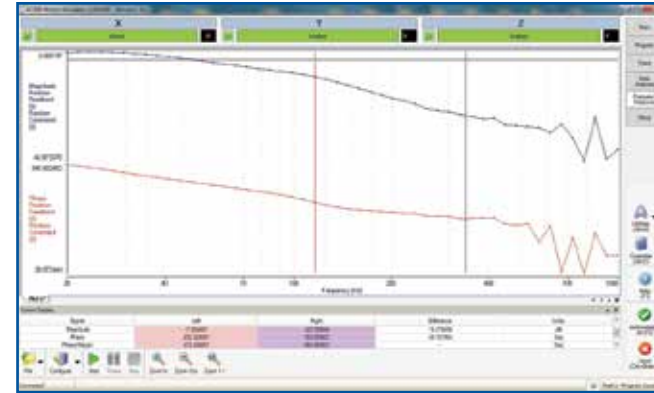

Frequency Response

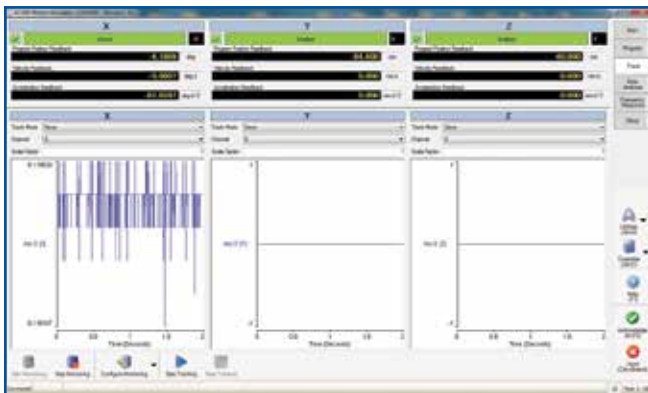

Track screen allows external signal selection for tracking

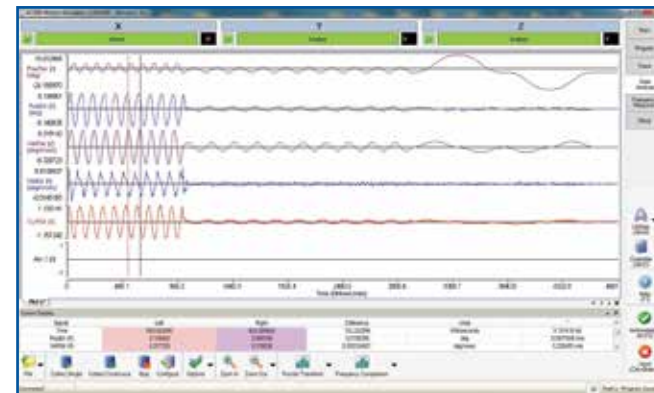

Data Analysis

Generate Motion Programs Directly From Your CAD Drawing

- Easily imports vector-based drawing files and produces G-code motion programs
- Interactive canvas allows easy editing and creation of new shapes and text
- Automatic and manual shape re-ordering options allow for optimal tool and processing paths
- Export to RS-274D G-code format
- Allows user-defined initialization, process shutdown, and shuttering commands (tool on/off)
- Offers seamless use of Aerotech's powerful controller features such as PSO (Position Synchronized Output)

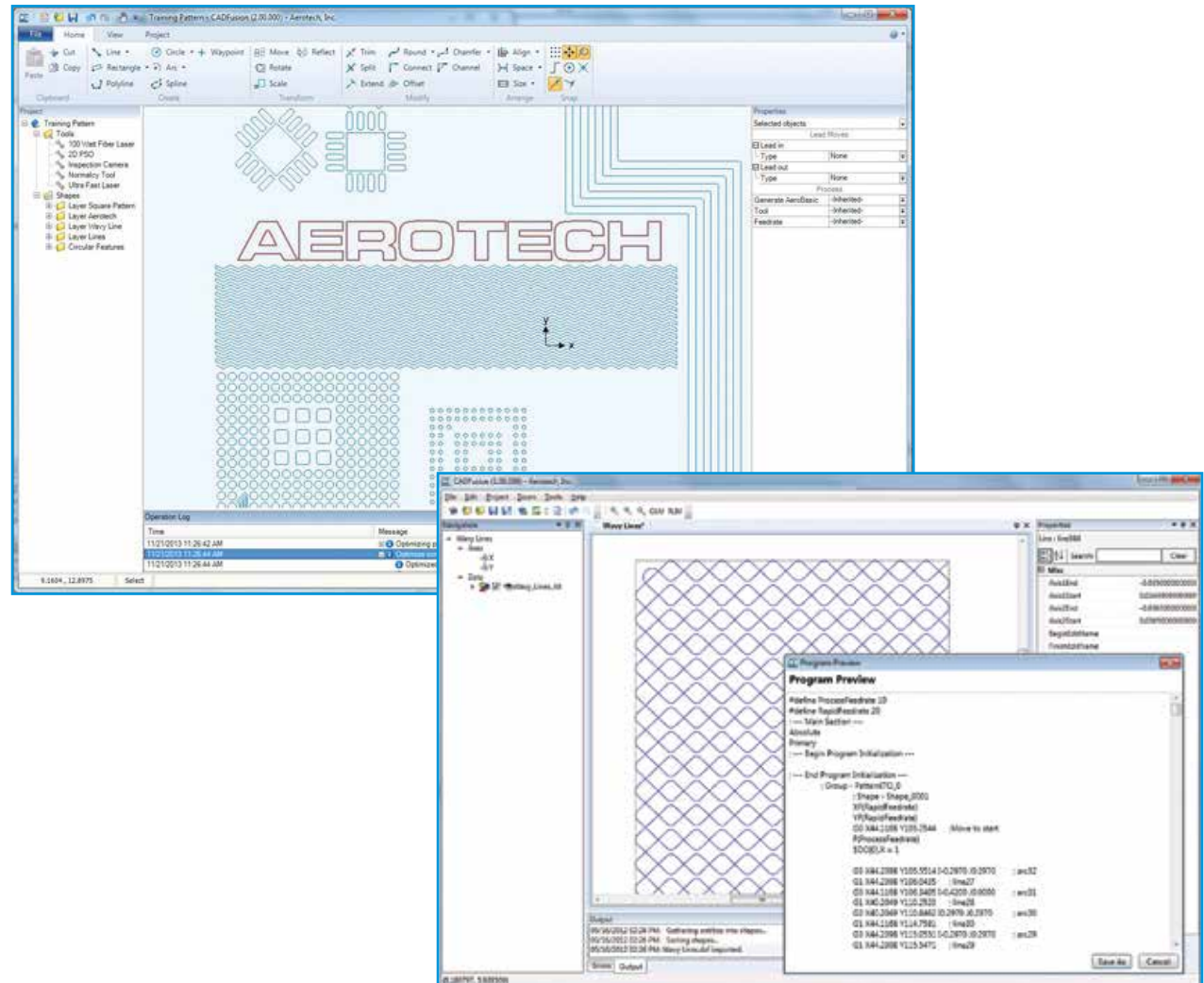

Open Simulation Environment

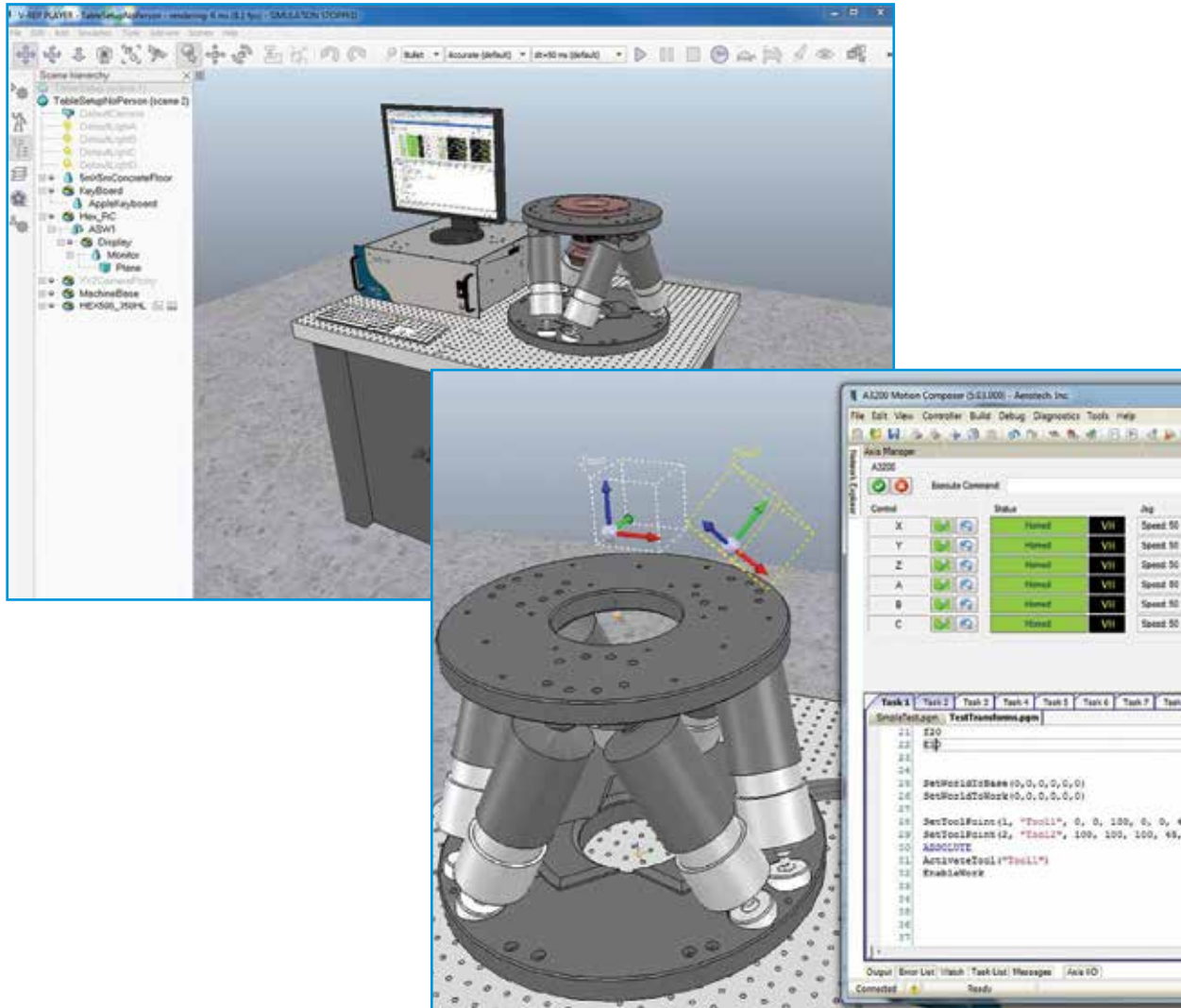

- Support for Coppelia Robotics virtual robot experimentation platform (V-REP)
- Full system modeling capability
- Visualization and selection of coordinate systems for multi-DOF systems like hexapods
- Pre-configured models connect directly to Aerotech's A3200 motion controller
- Import custom objects as 3D mesh files
- Supports collision detection between all elements in the environment
- Control grippers and vacuum pickup devices with Aerotech I/O

- Use the Aerotech Operator Interface (OI) for fast deployment
- Customize the OI to suit the application
- User customizable buttons that can execute standard G-code and AeroBasic™

Configurable Operator Interface

The screenshot shows the Aerotech A3200 CNC Operator Interface software. The interface is divided into several sections:

- Issue immediate commands:** A section on the left with buttons for X, Y, Z, H, and A axes.
- Configurable axis manager:** A central table showing axis status and feedback data.

Axis	Position	Velocity	Acceleration	Distance	Velocity Feedback
X	60.305	mm/s	mm/s²	mm	24.641
Y	68.355	mm/s	mm/s²	mm	24.441
Z	0.694	mm/s	mm/s²	mm	0.244
H	68.355	mm/s	mm/s²	mm	24.441
A	0.000	mm/s	mm/s²	mm	0.000
- Configurable jog pad:** A section with buttons for +X, -X, +Y, -Y, +Z, -Z, +A, -A, and a Jogging Rate selector.
- User customizable buttons:** A grid of buttons labeled 'Enable 1' through 'Enable 4' for axes X, Y, Z, and U.
- Active program:** A text area showing G-code, with the line 'G90 G1 X10 Y=10 Z=10 F10.0' highlighted.
- Standard machine controls:** A row of icons for 'Open (Ctrl+O)', 'Close (Ctrl+W)', 'Edit (Ctrl+E)', 'Cycle Start (F2)', 'Feedhold (F3)', and 'Abort (Ctrl+Shift+A)'. A 'Task 1 - Program Running' indicator is also present.
- Designed for touch screen:** A section with 'Jog Pad' and 'Velocity' controls, including 'Low', 'High', 'Distance', and 'Distance Hold' buttons.
- Set up simple or complex action — user can attach a standard G-code program to a button:** A section with 'Axis Control' and 'Select Page' options.

Layered for flexibility • Customizable at many layers • Most cost-effective solution

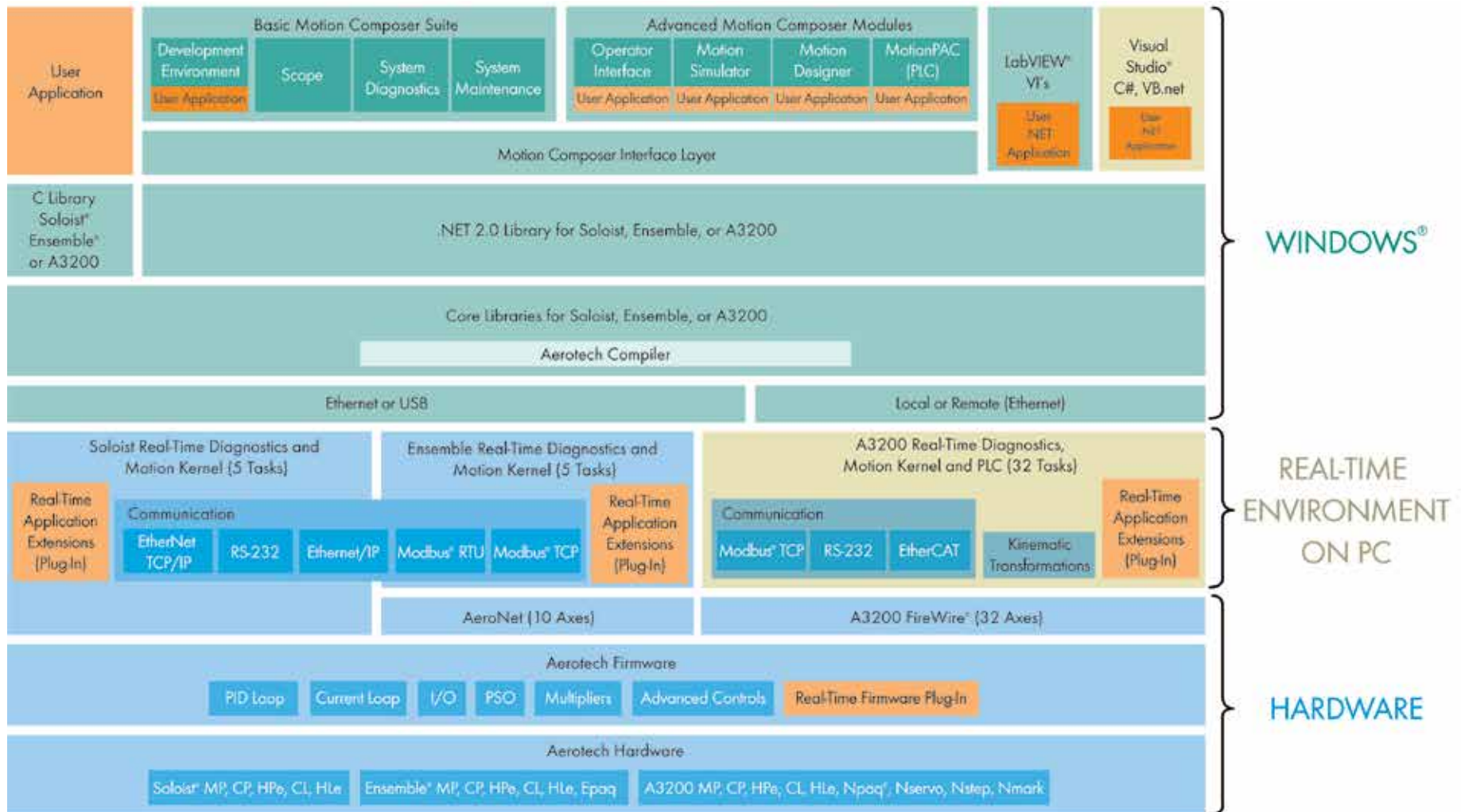



Digital Automation Platform

- Higher throughput due to high performance control, network and high-power drives
- Higher accuracy and repeatability due to all digital drives and advanced servo algorithms
- Faster startup and changeover results from fully integrated motion platform, easy-to-use setup tools and extensive diagnostics
- Lower startup and life-cycle cost due to less components and reduced engineering
- Higher reliability due to fewer components
- Simplified integration

Distributed Motion Control

- Motion trajectory generation and synchronization are centralized at the PC
- Motion execution is decentralized at the drives
- A3200 operates on any standard desktop or industrial PC
- Servo loops are closed on the drive

Use Nservo to Retrofit Existing Motors & Drives or Drive Large Motors

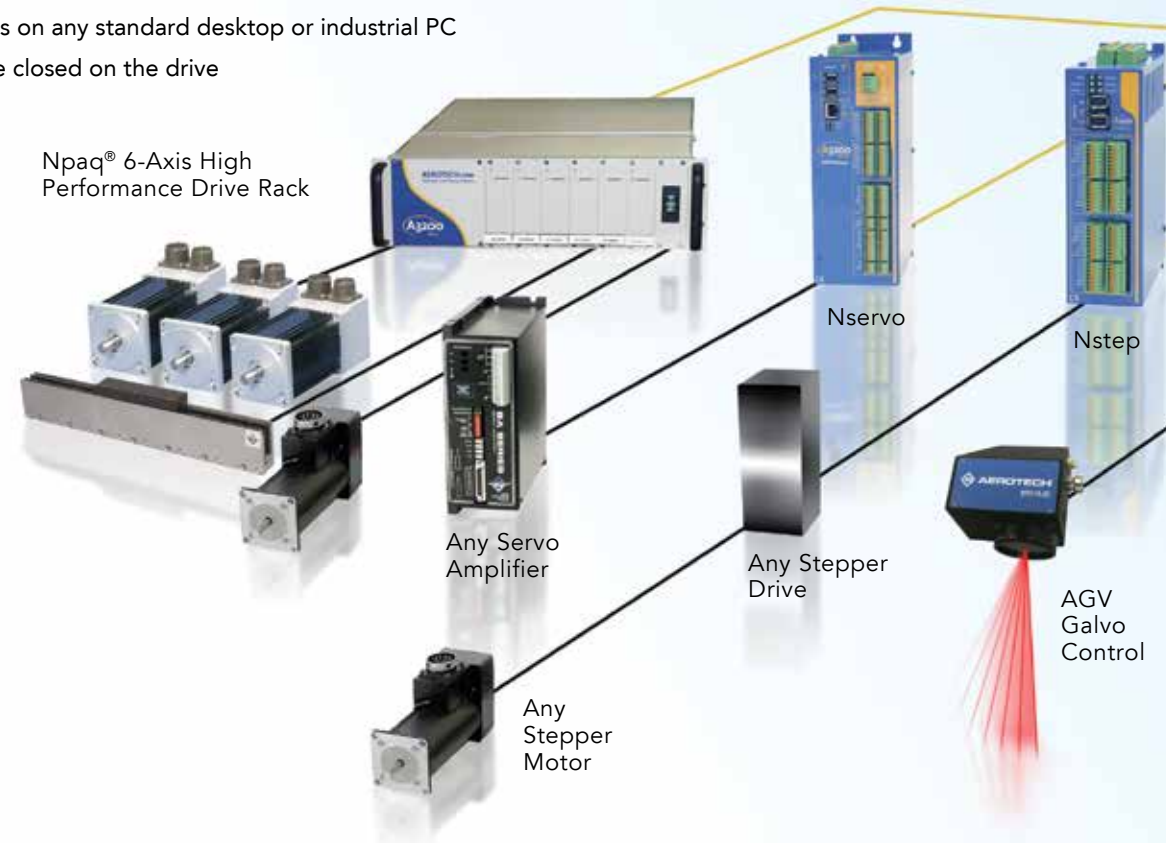

The Intelligent 32-Axis Motion, Vision, PLC, Robotics and I/O Platform

- Easily installed digital drives
- FireWire® (IEEE-1394) industry standard, high-performance motion bus

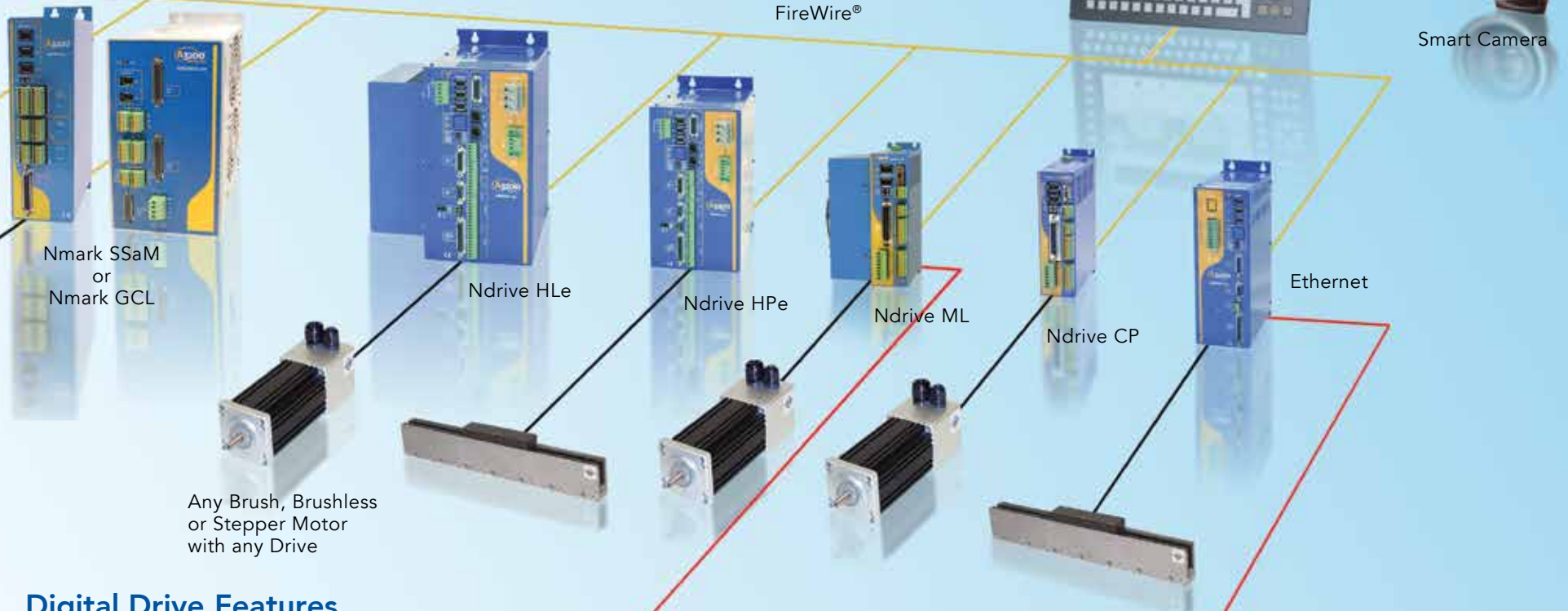

Any Brush, Brushless or Stepper Motor with any Drive

Digital Drive Features

- PWM or linear (10 A to 150 A peak)
- Integrated 10/100 Base-T Ethernet
- Encoder, resolver or inductosyn feedback
- Onboard x65536 encoder multiplication
- 20 kHz position, velocity and current-loop sample rate
- Integral power supply
- Sinusoidal commutation
- Local I/O ports

Easily integrates with Keyence LK-G Series Laser Displacement Sensors

Ethernet I/O Expansion
Analog and Discrete I/O

Stand-Alone Multi-Axis Automation Controller

Ensemble[®]

Stand-Alone Multi-Axis Automation Controller

- Easy to use
- Powerful architecture
- Distributed control
- Network ready

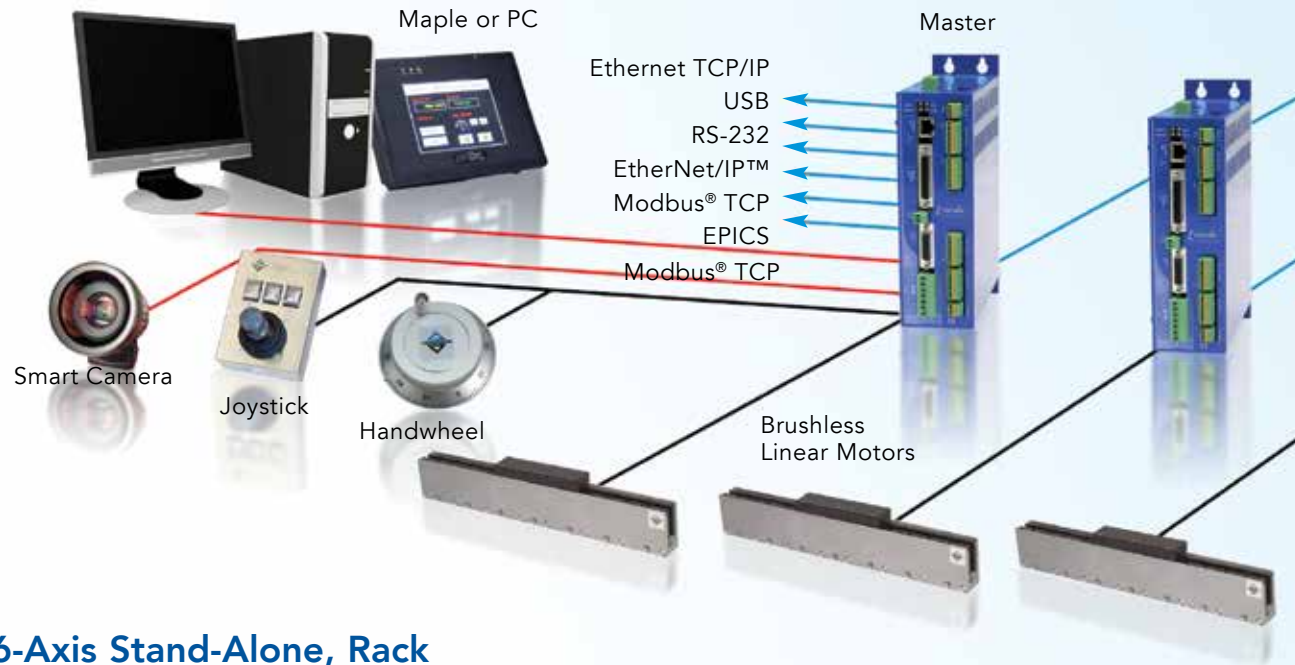

6-Axis Stand-Alone, Rack Mount or Desktop Plus Three Axes



Software, Controls, Drives and I/O... All in One Package

10-Axis, Stand-Alone, All Digital, Panel-Mount Controllers

from 10 to 150 A peak

AeroNet

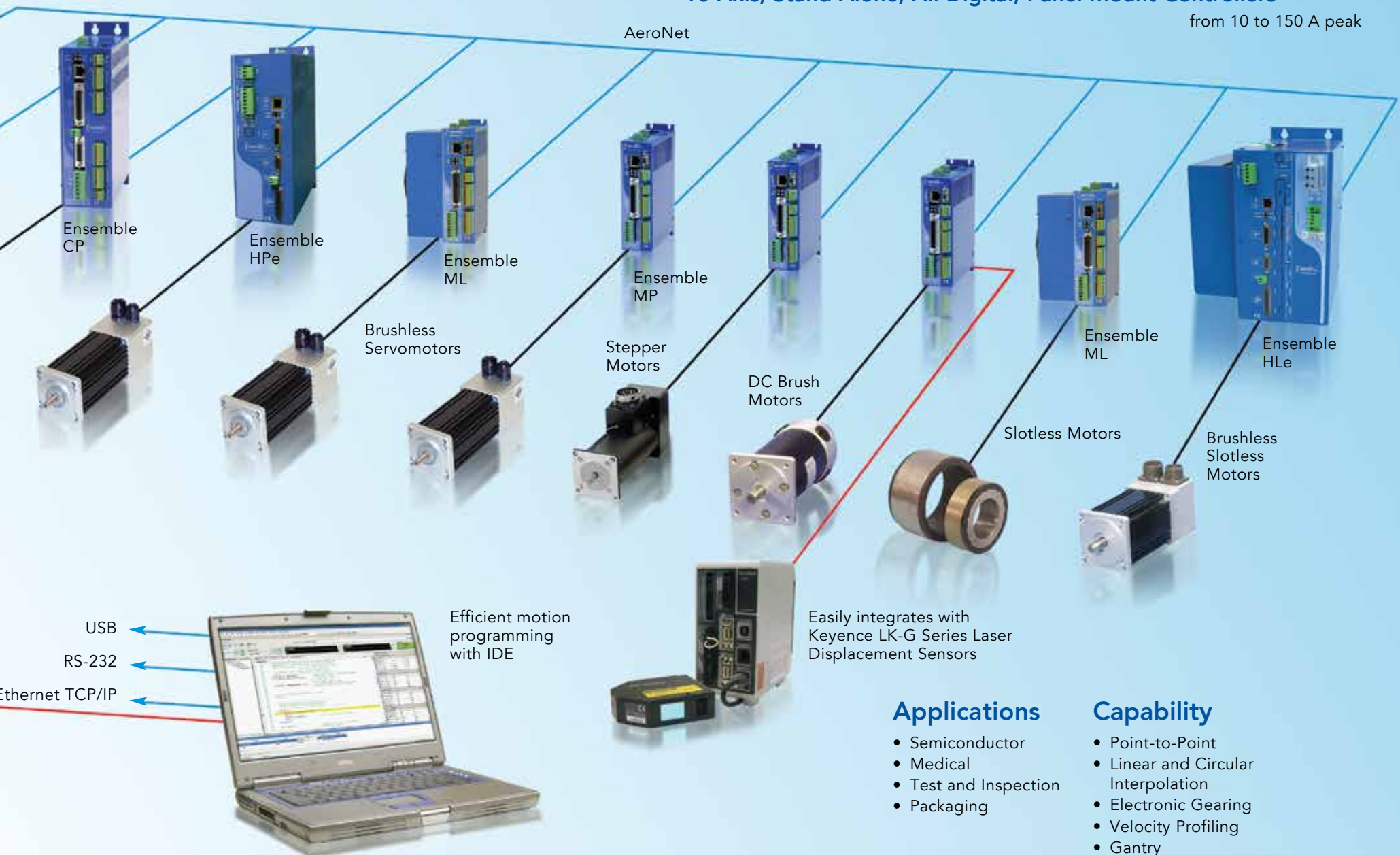

USB

RS-232

Ethernet TCP/IP

Efficient motion programming with IDE

Easily integrates with Keyence LK-G Series Laser Displacement Sensors

Applications

- Semiconductor
- Medical
- Test and Inspection
- Packaging

Capability

- Point-to-Point
- Linear and Circular Interpolation
- Electronic Gearing
- Velocity Profiling
- Gantry

Stand-Alone Single-Axis Automation Controller

Soloist[®]

Stand-Alone Single-Axis Automation Controller

- Easy to use
- Scalable
- Ethernet/USB connectivity

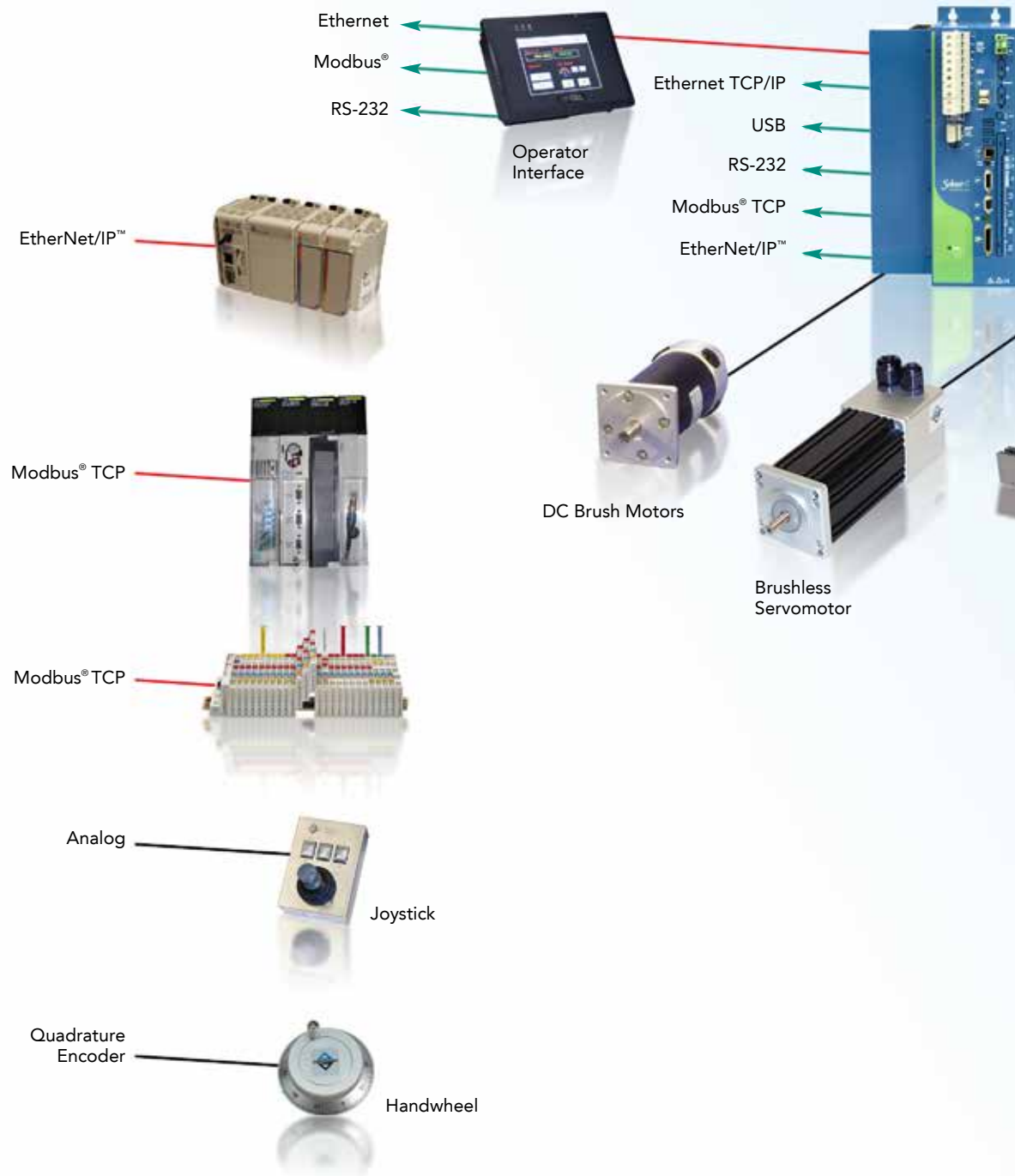

Software, Controls, Drives and I/O in One Compact Package

from 10 to 150 A peak



Soloist HPe 150



Soloist HPe



Soloist CP



Soloist MP



Soloist ML



Soloist HLe



Brushless Linear Motors



Stepper Motors



Slotless Motors



Brushless Servomotors



ASR2000 Spindle



Easily integrates with Keyence LK-G Series Laser Displacement Sensors



LAN/WAN/Internet up to 1024 on one network

Connect, program or monitor locally or remotely

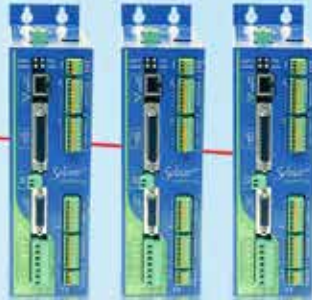

Controller and Drive Technology

MP for OEMs lowers costs • CP solutions for less integration work • HPe for the highest performance solution

Ndrive® MP Ensemble® MP Soloist® MP

Width: 41.1 mm
Height: 141.2 mm

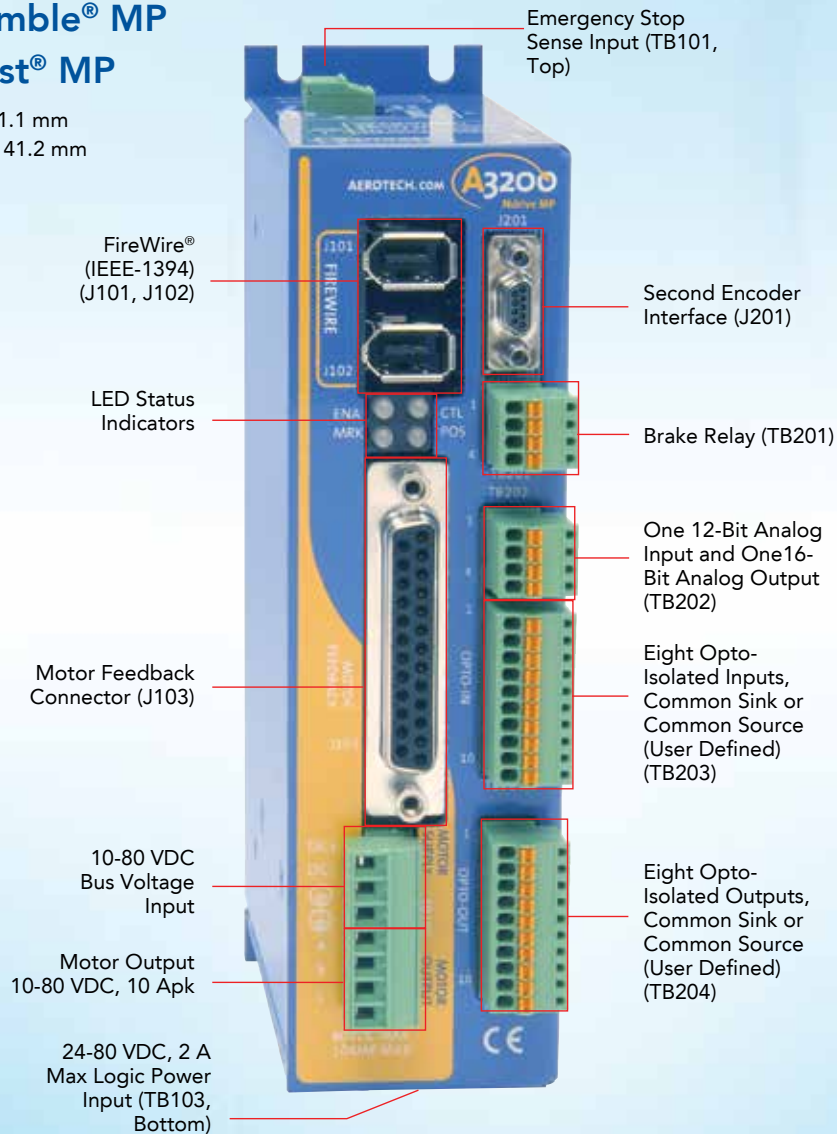

Ndrive® CP Ensemble® CP Soloist® CP

Width: 63.5 mm
Height: 198.2 mm

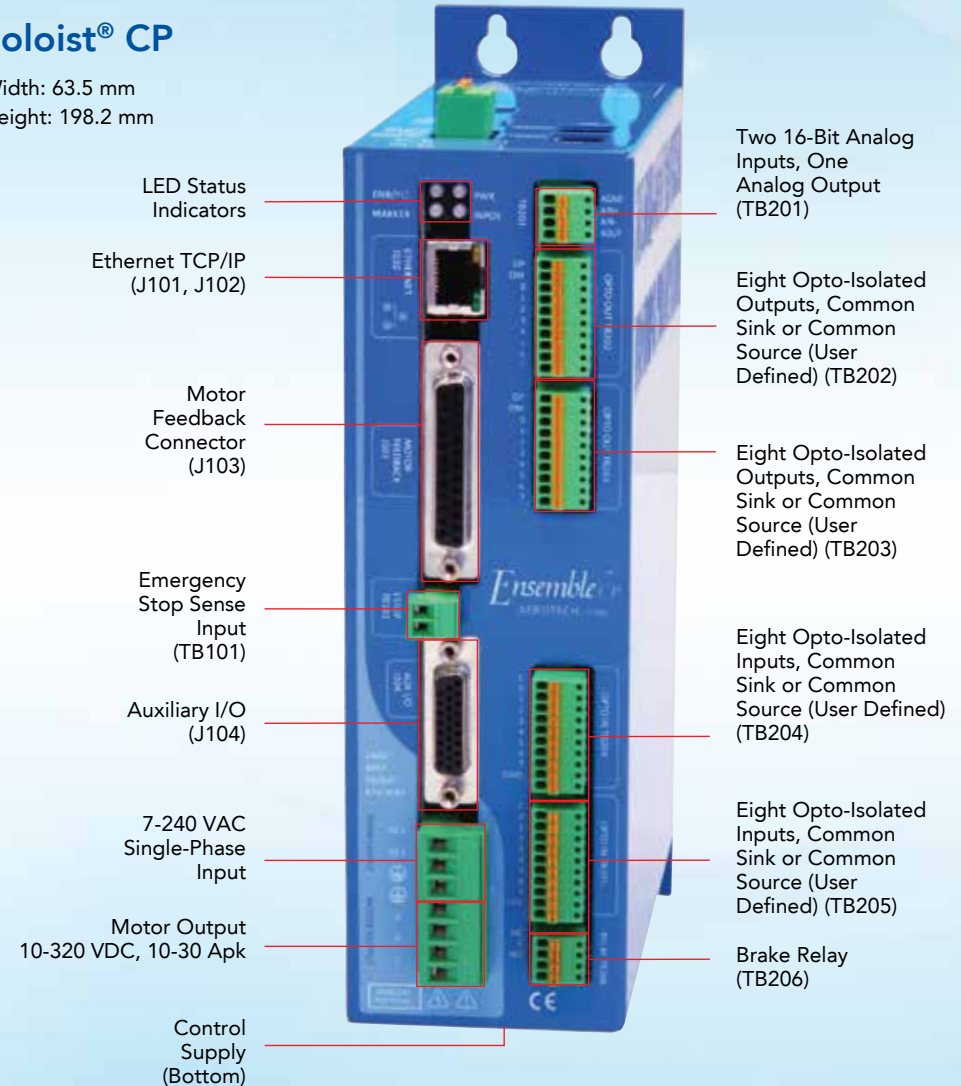

Ndrive® HPe
Ensemble® HPe
Soloist® HPe

Width: 99.1 mm
 Height: 232.5 mm

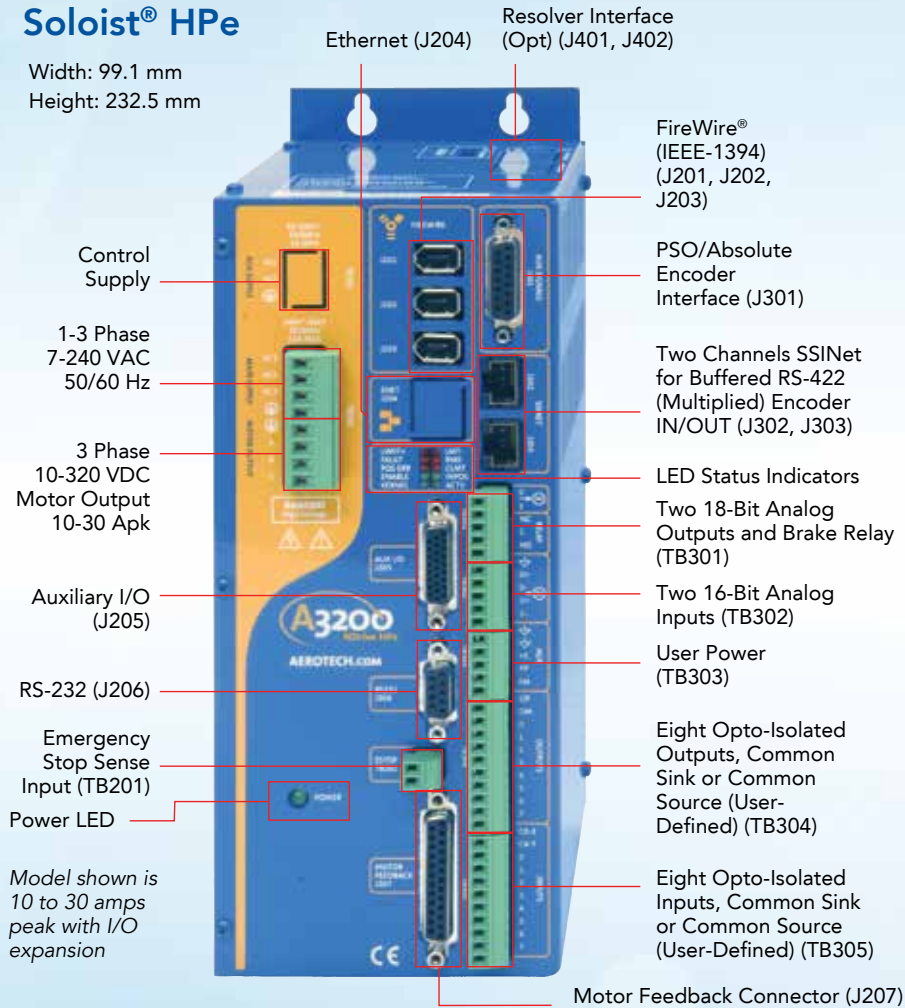

Ndrive® HPe
Ensemble® HPe
Soloist® HPe

Width: 212.6 mm
 Height: 234.8 mm

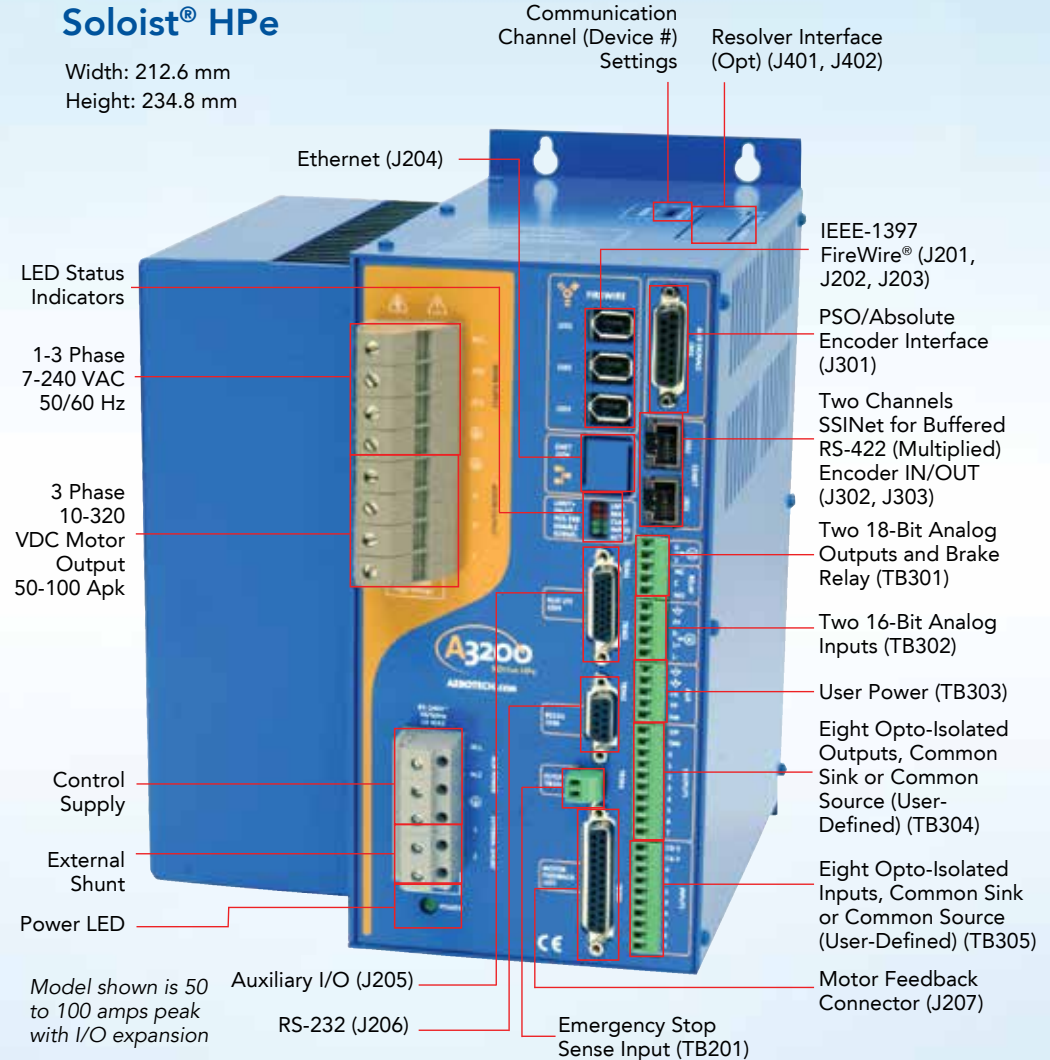

Controller and Drive Technology

Linear Drive Advantages

- Ultra-smooth motion during reversals
- Superior in-position stability
- Integrated with controls
- No switching noise
- No dead band
- Low EMI

Applications

- Nondestructive testing
- Stencil cutting
- Any small move, or sinusoidal movements
- Very slow velocity applications
- Stent manufacturing
- Target tracking
- Piezo stages

Ndrive® HPe150 Ensemble® HPe150 Soloist® HPe150

Width: 229.7 mm
Height: 406.1 mm

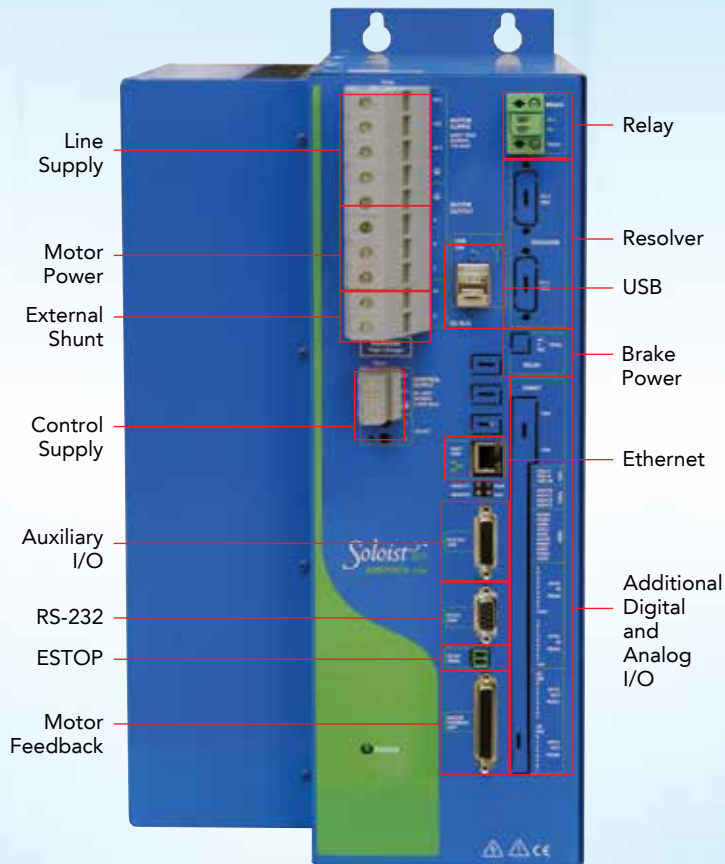

Ndrive® ML Ensemble® ML Soloist® ML

Width: 41.1 mm
Height: 141.2 mm

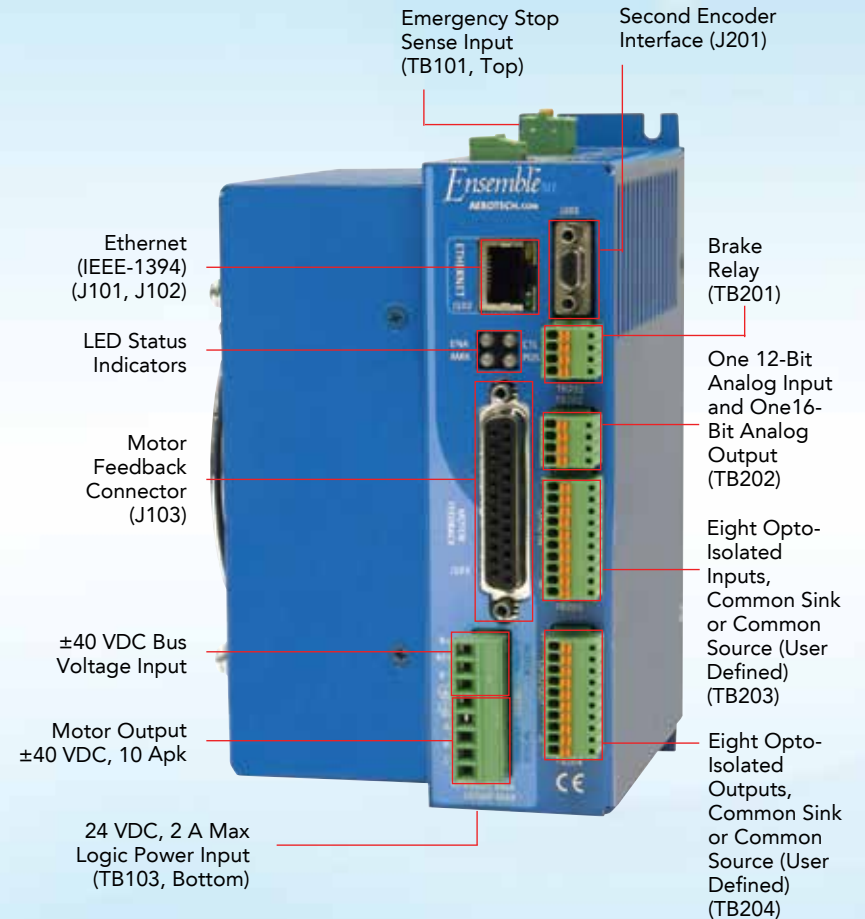

Ndrive® HLe Ensemble® HLe Soloist® HLe

Width: 206.9 mm
Height: 234.3 mm

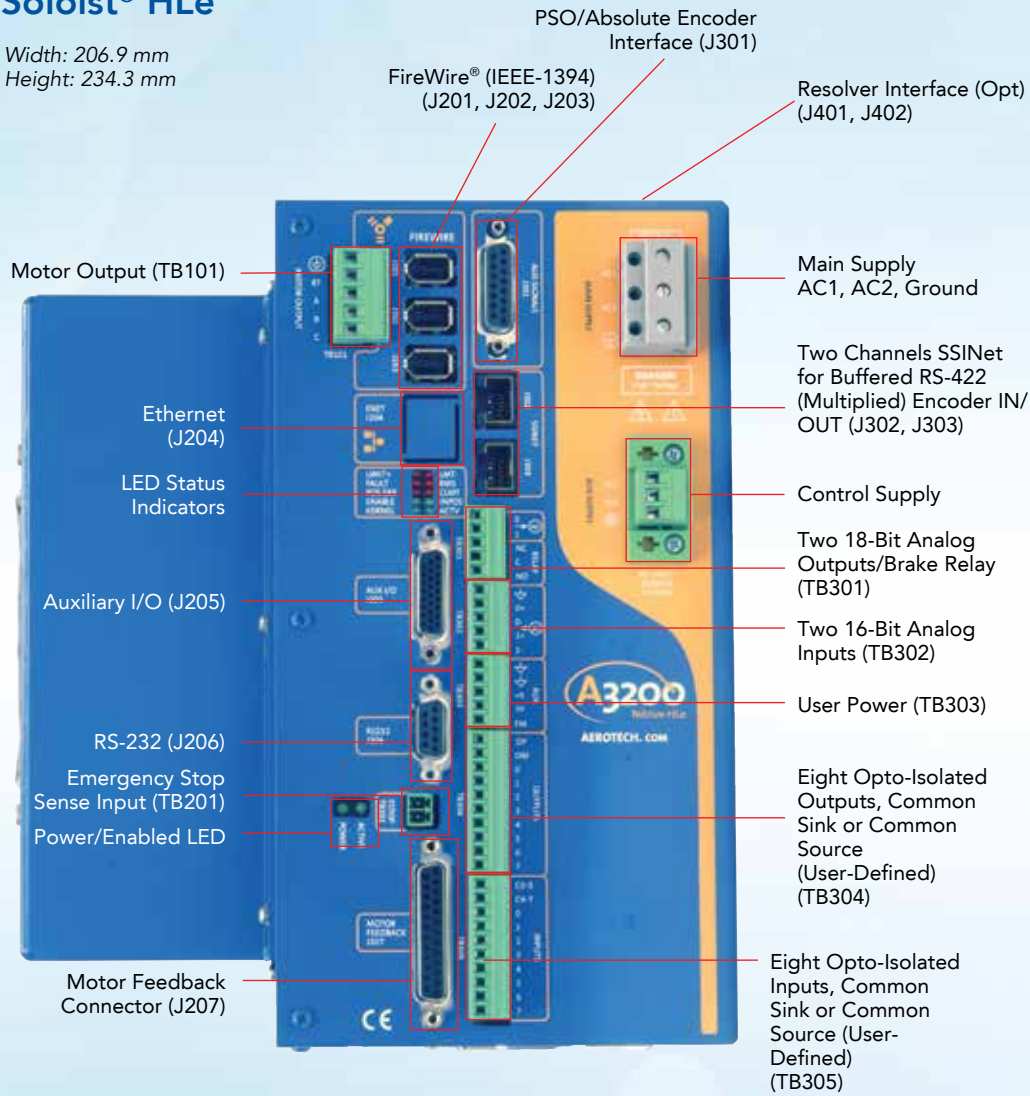

Nstep

Width: 49.2 mm
Height: 161.8 mm

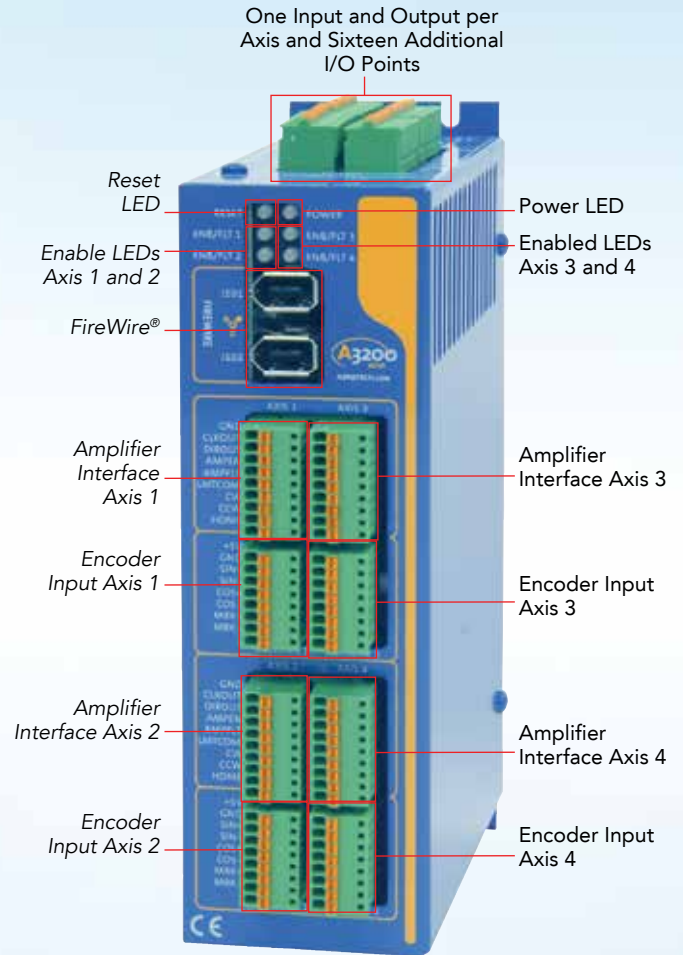

Controller and Drive Technology

Nmark® GCL

Width: 121.5 mm
Height: 219 mm



Nmark® SSaM

Width: 63.7 mm
Height: 199.0 mm

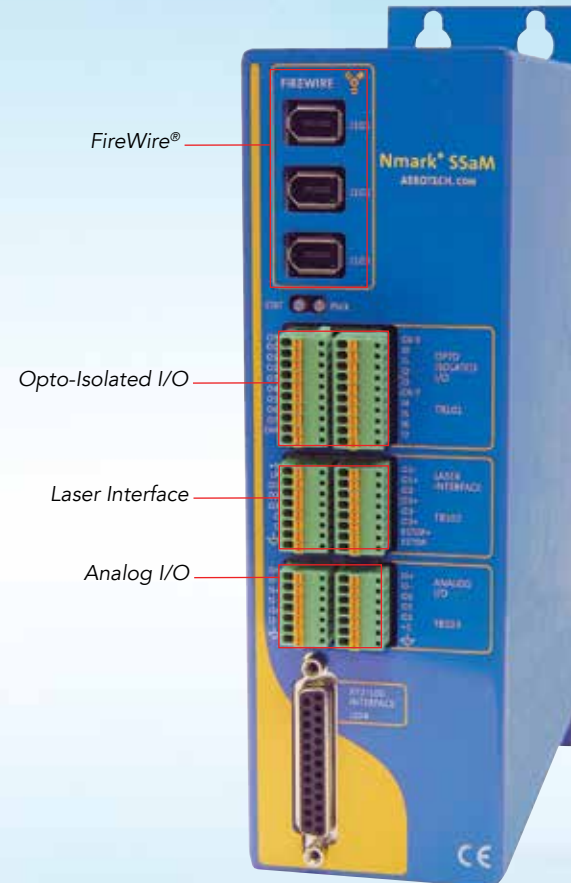

Nservo

Width: 87.6 mm
Height: 230.4 mm

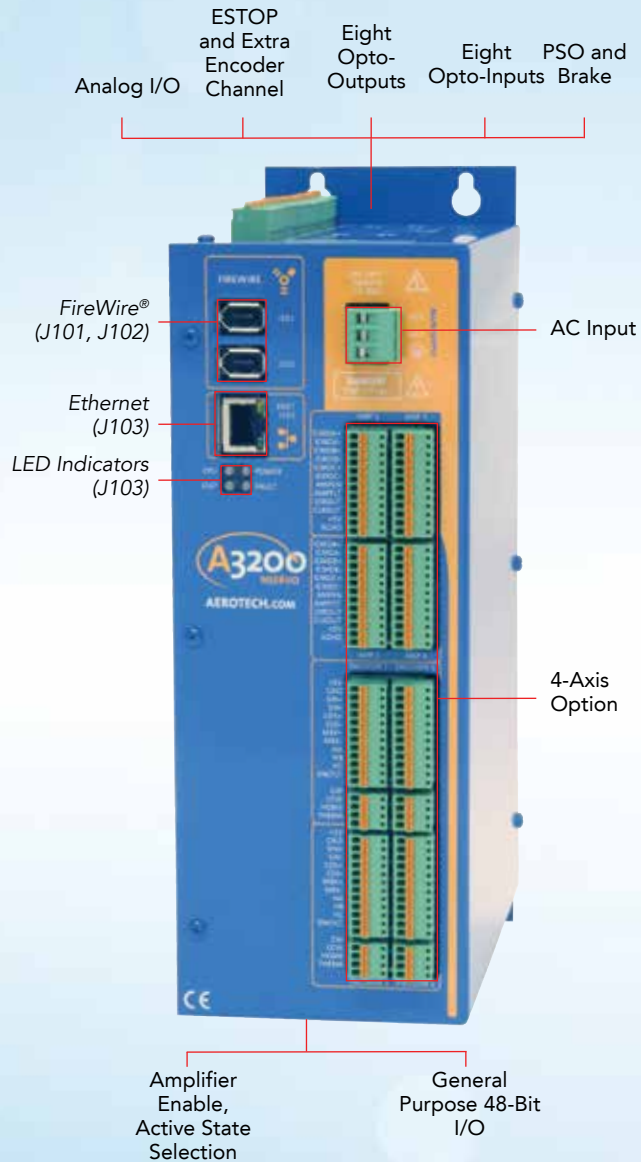

Nservo – OEM

4 Axis or Less
Width: 284.5 mm
Height: 276.9 mm

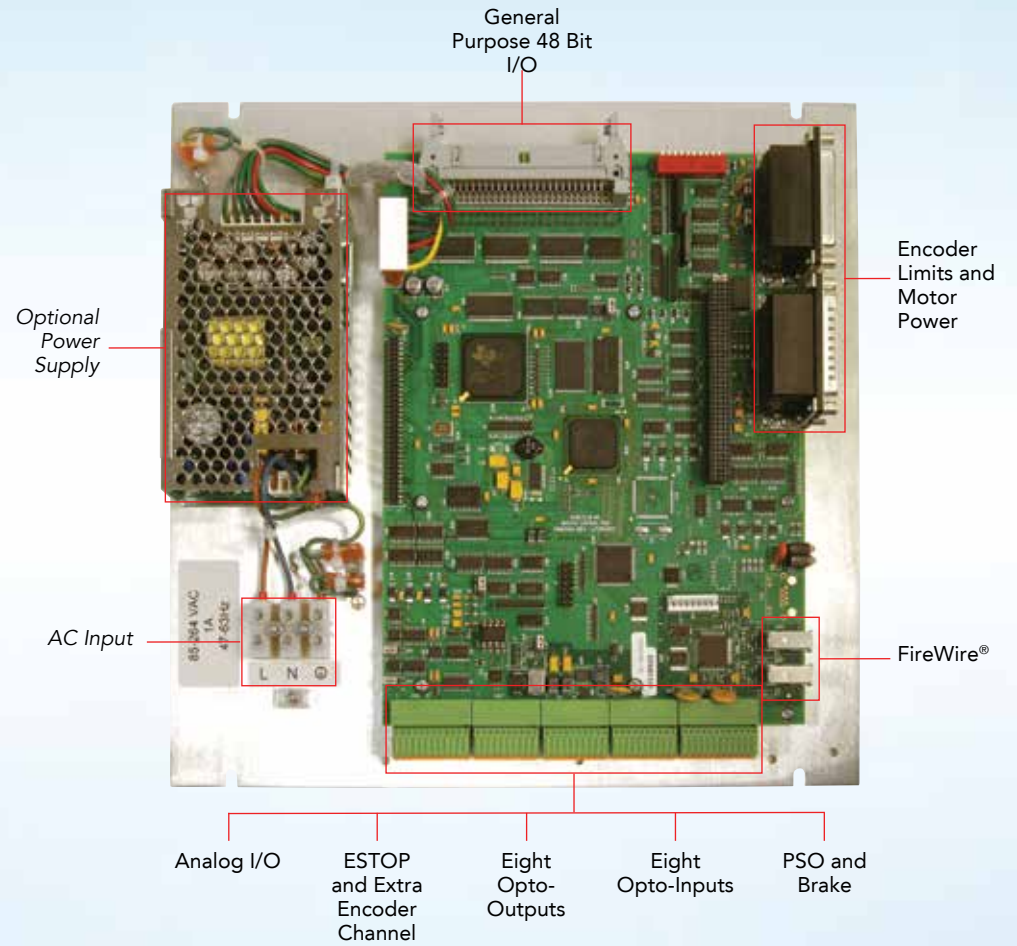

Controller and Drive Technology

Npaq® and Epaq Rack Mount or Desktop Solutions in One Box Minimize Wiring

Console



Npaq®

6 Axis or Less
Width: 436.7 mm
Height: 132.0 mm

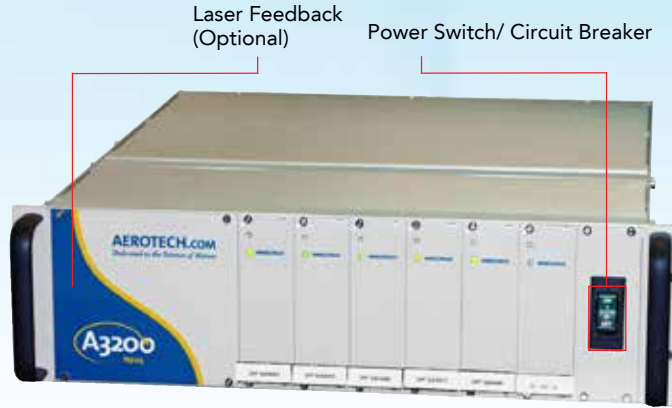

Npaq® MR/Epaq MR

8 Axis or Less
Width: 436.7 mm
Height: 132.0 mm

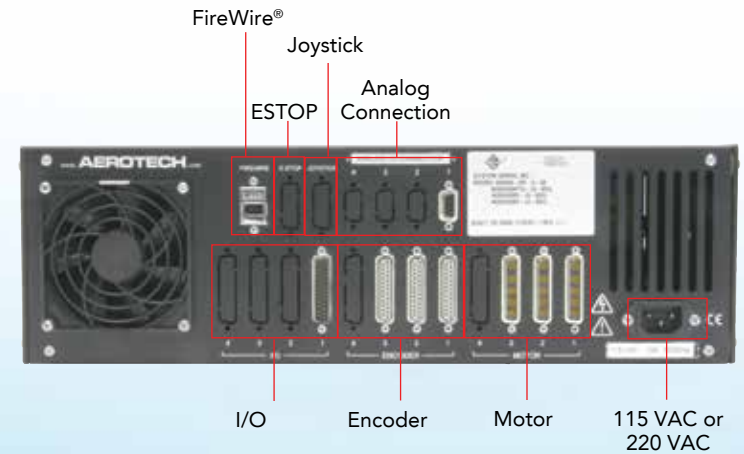
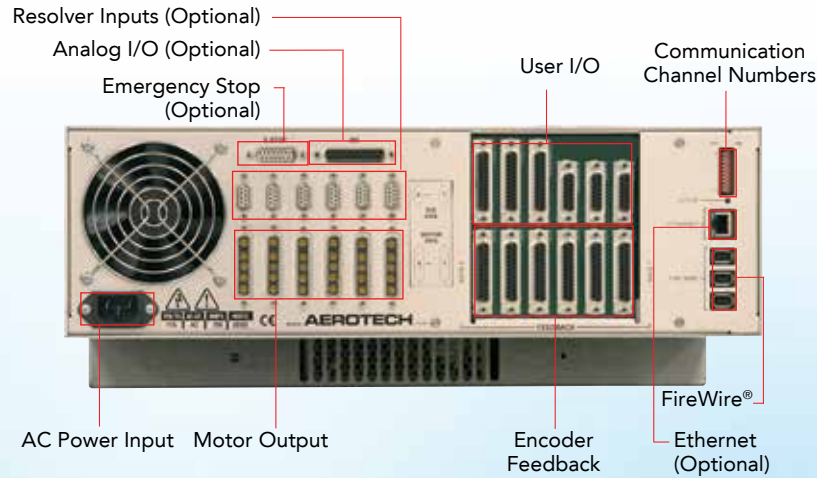
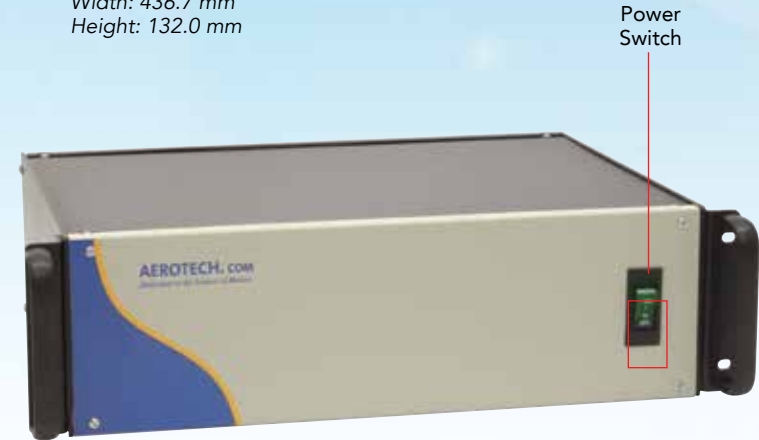

Ensemble® Epaq

5 Axis or Less
 Width: 431.8 mm
 Height: 177.8 mm

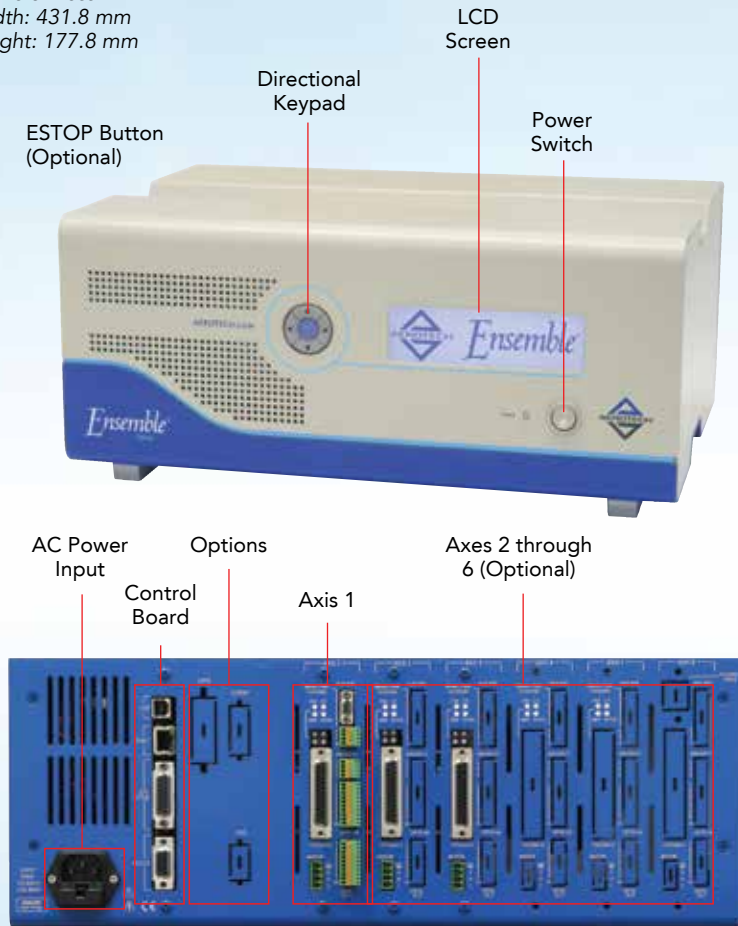

Ensemble® LAB

4 Axis or Less
 Width: 370.2 mm
 Height: 98.4 mm

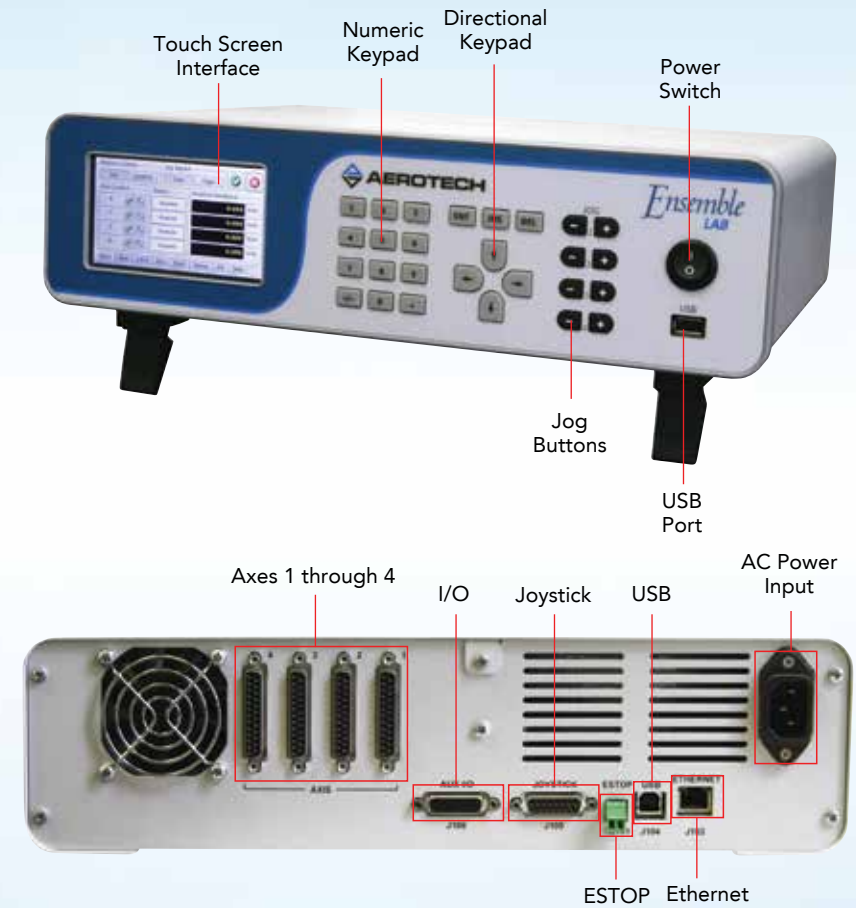

Standard Control Capabilities

Aerotech controllers offer the broadest array of programming interfaces and core motion capabilities of any automation system available today. Aerotech controllers have the programming flexibility and capability to meet the requirements of the most demanding motion applications of OEMs and end-users alike.

Point-to-Point Motion

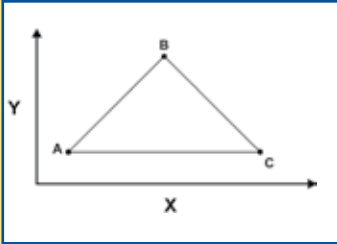

Basic independent axis positioning with programmable accel/decel and feedrate.

Acceleration Limiting

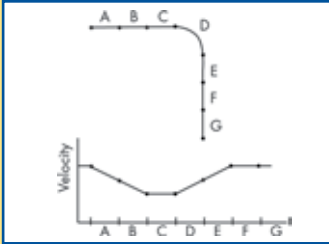

Anticipate sharp corners and small radius arcs and automatically decelerate as needed.

Coordinated Motion

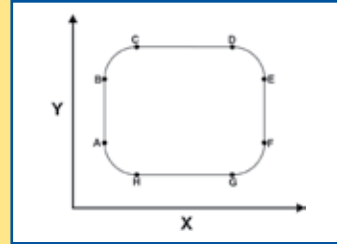

Linear and circular motions are supported in all languages.

Arbitrary Path Generation (PVT)

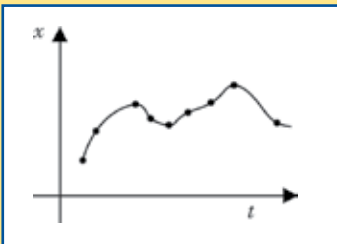

Specify discrete position, velocity and time and the controller will interpolate to create a smooth, contiguous path.

Electronic Gearing

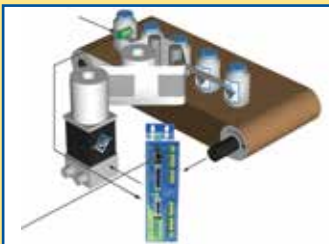

Electronically control one axis as a simple ratio or as a complex function of another axis; fire I/O in real time during a move.

On the Fly End-Point Modification



Modify the endpoint during execution of the motion profile.

Cutter Compensation

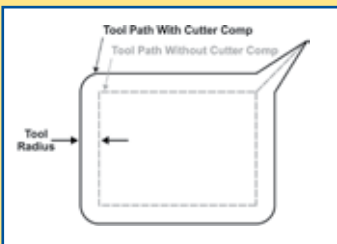

Also known as tool radius compensation, this feature automatically adjusts the path to allow for the radius of a cutting tool.

Parts Rotation

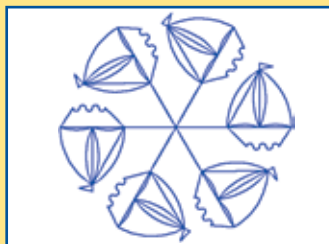

Use when a two-dimensional part must be repeated in different orientations without translating the part program many times over.

Velocity Profiling

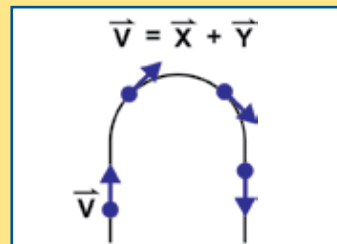

Maintains a constant vector velocity along the programmed path.

Seven Segment Acceleration

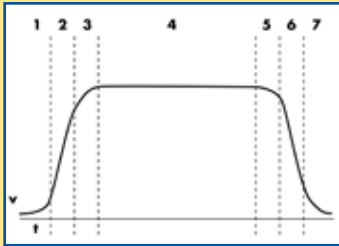

Specify the acceleration profile in seven segments, providing precise control over system motion.

Velocity Blending

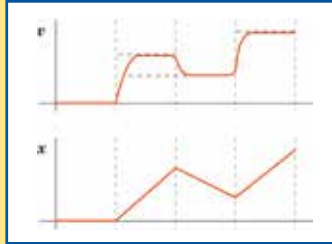

The velocity changes to the next velocity command, acceleration limited, without stopping.

Fast Position Capture

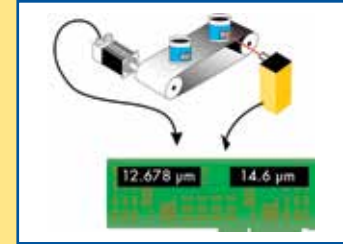

Store positions based on the transition of a digital input, allowing close correlation of axis positions to external events.

Retrace

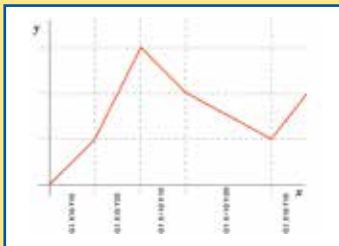

Retrace a path block by block.

Intra-Block Retrace

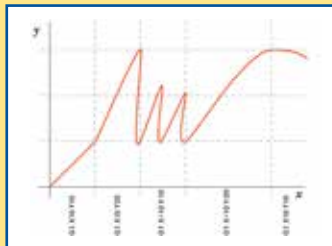

Retrace a path inside a block.

High-Speed Registration

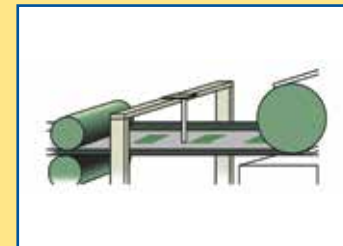

High-speed registration to trigger motion is useful in packaging and labeling.

Gantry Mode



Complex gantry control is reduced to a few simple commands to handle dual motor and/or dual feedback configurations.

Kinematics

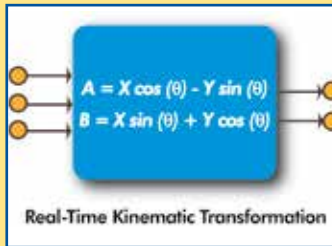

Execute complex inverse kinematic equations within the flow of the trajectory generation.

Analog Power Control



Adjust the setting of an analog output in relationship to the vector speed of two axes to permit the automatic regulation of laser power or material dispensing processes.

Standard Control Capabilities

Motor Control

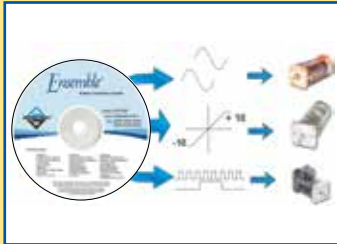

All controllers operate brush, brushless or stepper motors in any combination.

Orthogonality Correction

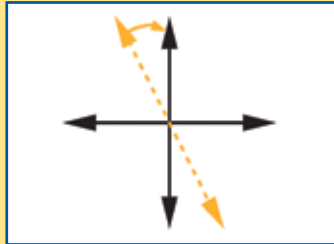

Improve X-Y planar accuracy by simply entering the known orthogonality error and the controller will compensate.

Axis Calibration

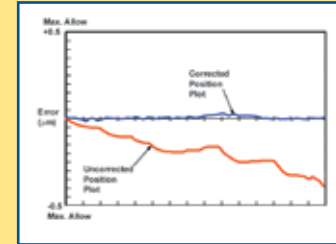

Compensate for repeatable mechanical errors in a positioning system.

Sinusoidal Commutation

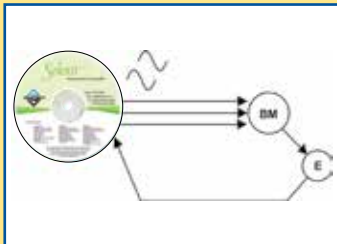

Brushless motors produce smoothest motion when sinusoidally commutated, eliminating the need for multiple transducers and reducing cabling.

3D Error Correction

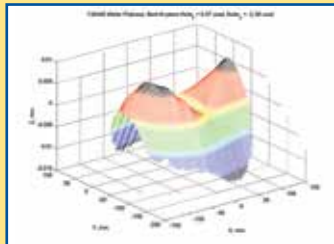

Measure XYZ errors and the controller can correct the commanded position to accurately move to all locations in the 3D space.

Dual-Loop Control

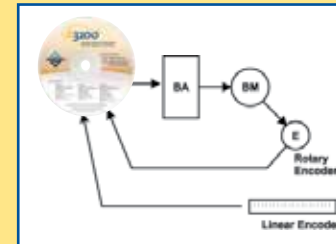

Dual-loop control is used to eliminate the effects of backlash and other sources of error.

Quadrature Encoder



Use a standard A,B quadrature encoder, incremental or absolute.

Analog Feedback



For high resolution, short travel applications, linear drives accept analog inputs from analog sensors.

Resolver/Inductosyn

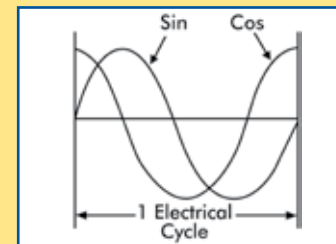

Programmable carrier frequencies make resolvers/inductosyns easy to integrate.

Laser Interferometer

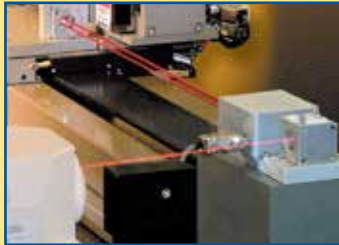

Systems requiring ultra-high resolution and feedback stability use interferometer feedback.

Encoder

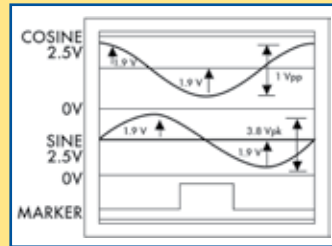

Systems requiring high resolution use a 1 Vpp encoder with Aerotech multiplier, up to 65,536 and 2 MHz input frequency.

Tachometer

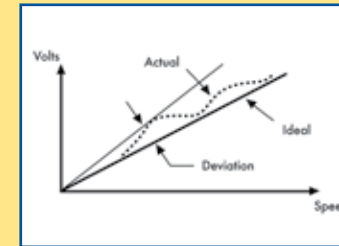

For dual feedback systems use tach for velocity control and encoder for position control.

PIDFF

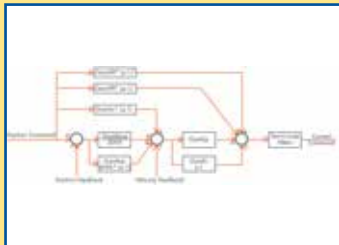

PID digital control loop with feedforward for velocity, acceleration and friction.

Safe Zones

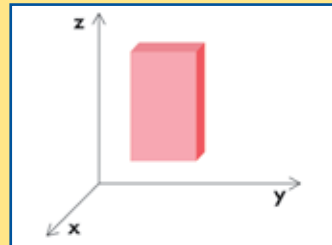

Safe zones can be set up on multi-axis systems to protect against crashes.

Slice Move

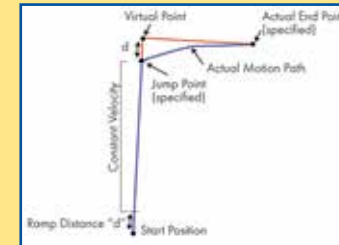

Increase scanning throughput by blending step and scan into a contoured move.

Limits



Set up hard limits and soft limits for maximum safety and flexibility.

Spindle Control



Spindle commands use standard m-codes.

CAM Profiling

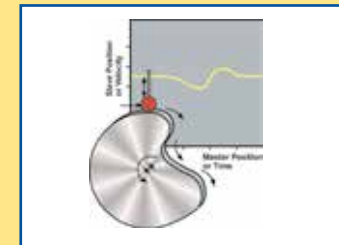

Electronically command one axis position as a function of another axis with a CAM table and fire I/O during the move.

Reduce Position Error

Harmonic Cancellation

- Reduce position error on periodic trajectories
- Reject periodic disturbances
- Built-in setup wizards
- Adapts to magnitude and frequency of error source

Continuously adapts and tracks sinusoids

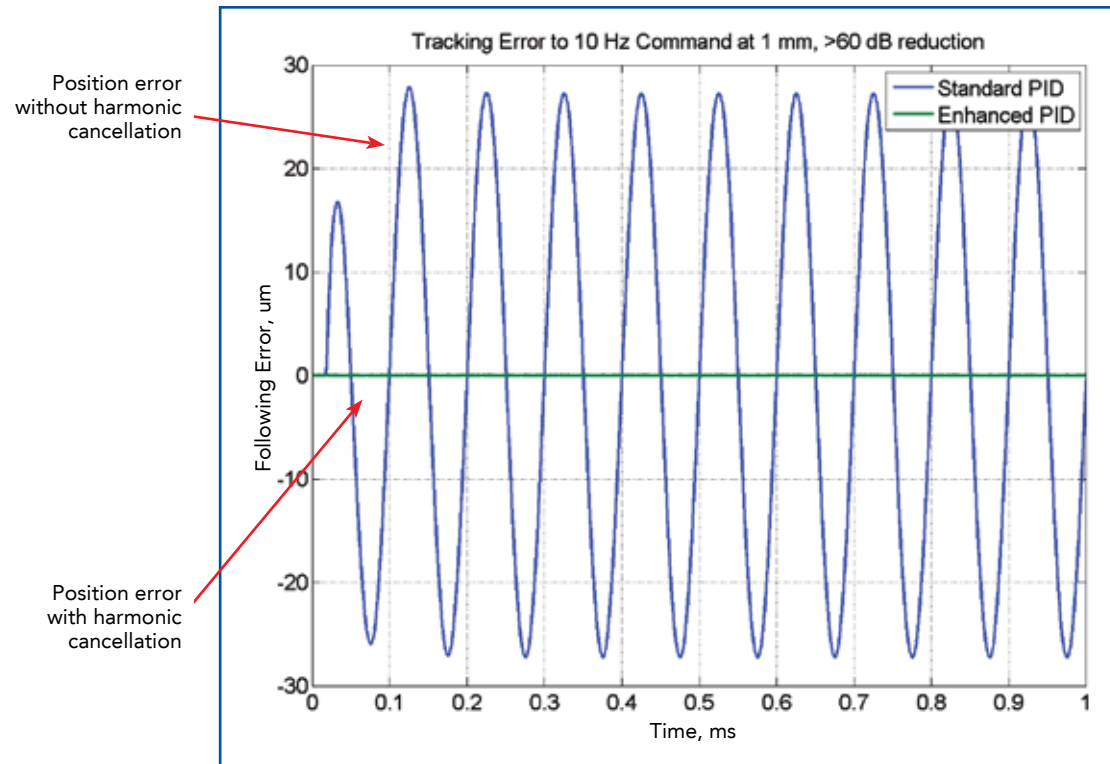

10 Hz Command; ± 1 mm

Applications

- Machining
- Spindle Control
- Cogging Reduction
- EDM/ECM
- MEMS Sensor Testing
- R0 Wafer Inspection

1st Iteration

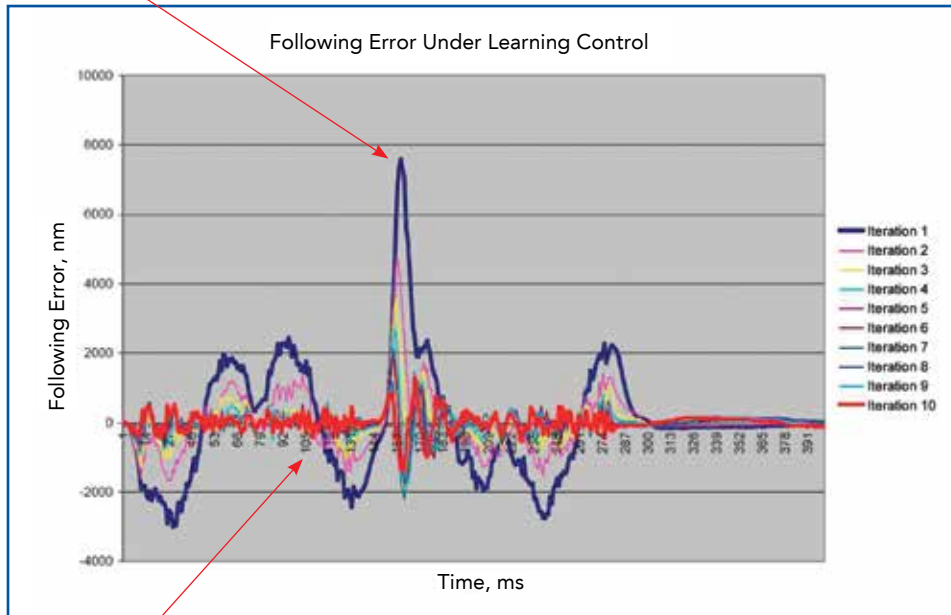

Final Iteration

Iterative Learning Control

- Repeating move sequences can be learned and optimized
- Reduce following error
- Increase dynamic accuracy
- Increase production rates

Applications

- Stencil Cutting
- Sensor Testing
- Stent Cutting
- Micromachining

Enhanced Throughput Module (ETM)

- Multi-axis feedforward capability
- Faster settling time
- Increase rate stability

Improved Settling Time

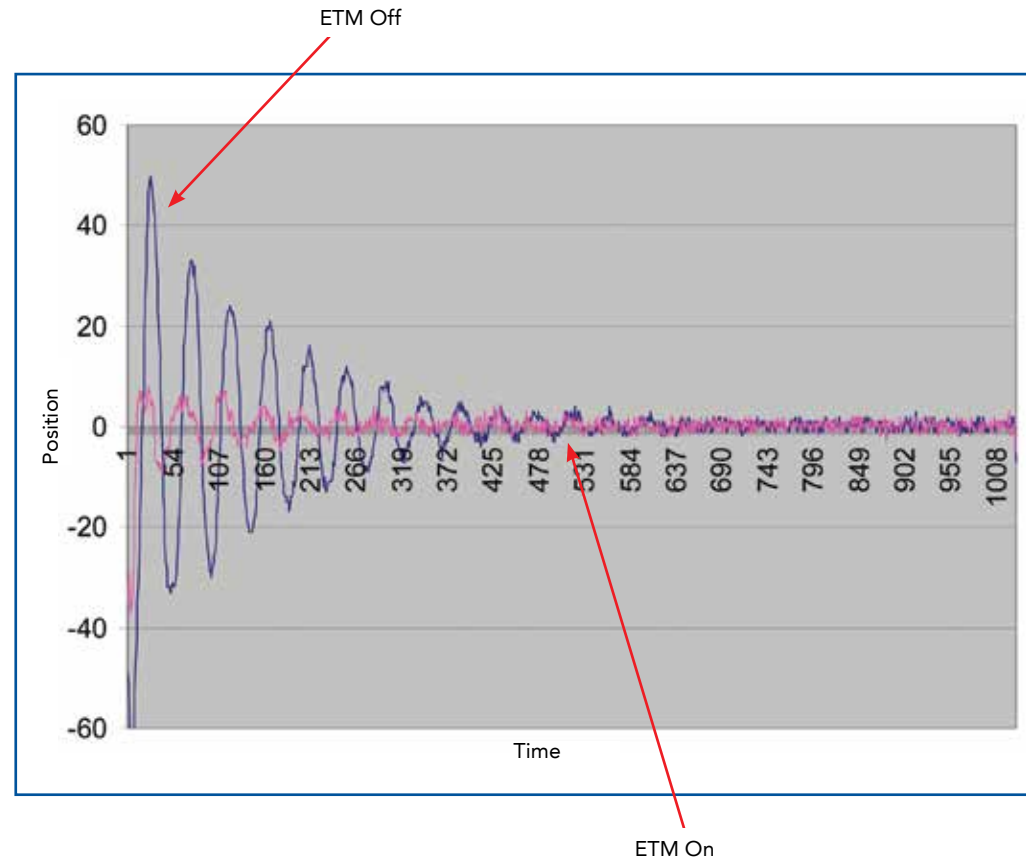

Applications

- Pick and Place Machines
- Semiconductor Inspection
- Genome Sequencing

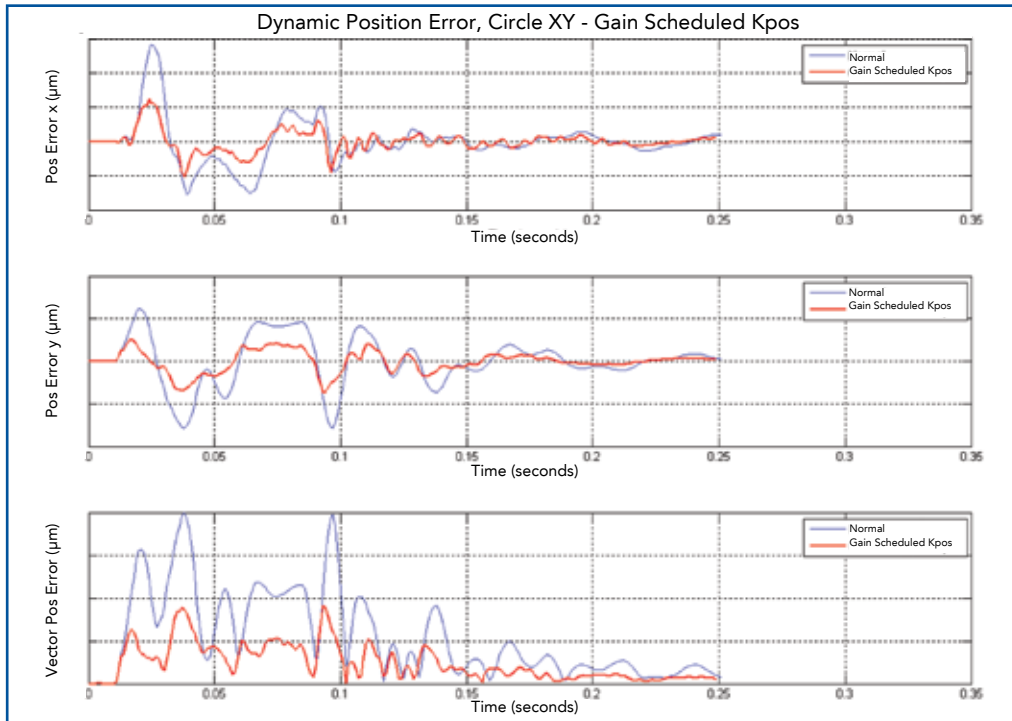

System automatically adjusts gain based on error motion during settling

Directional Gain Scheduling

- Decrease settle time
- Increase in-position stability

EasyTune®/EasySetup

- Automatically tune servo and piezo axes
- Hands-off! EasyTune requires no user input or controls knowledge
- Set a custom performance target – improves throughput and system stability

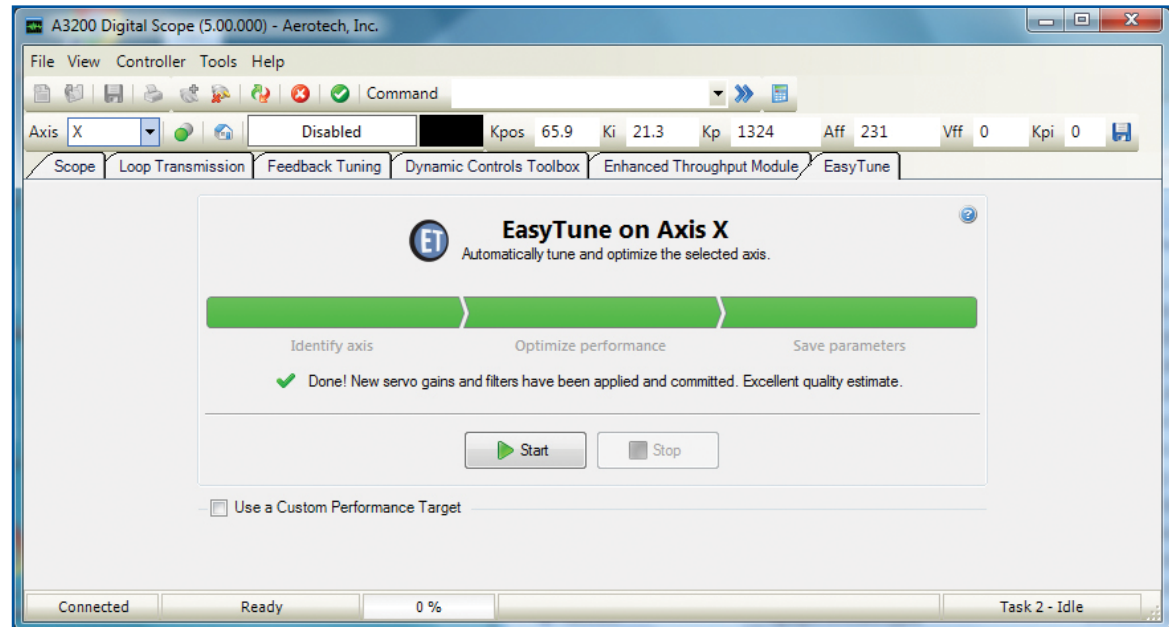

EasyTune®

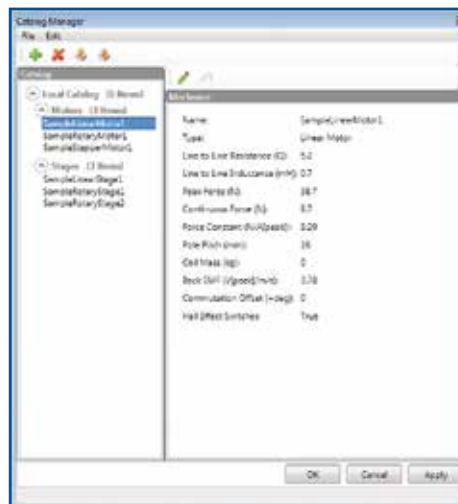

Catalog Manager

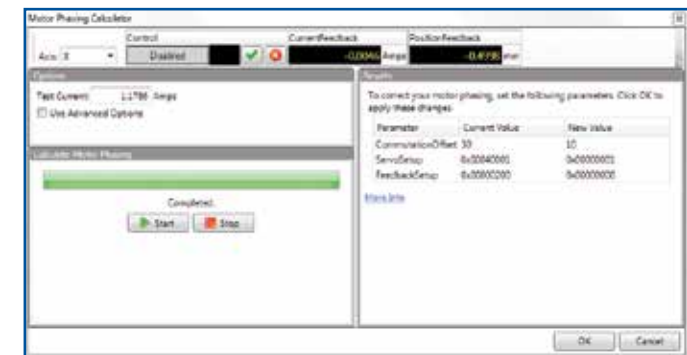

Motor Phasing Calculator

Reduce cross-axis position error during acceleration

Without cross-axis feedforward

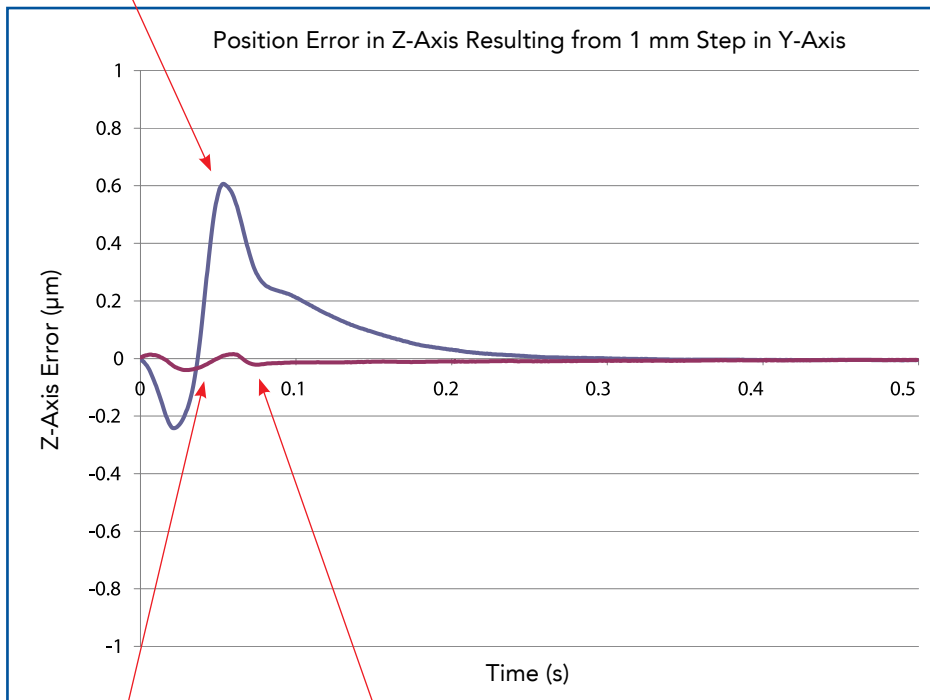

15x reduction in peak error

With cross-axis feedforward

Cross-Axis Feedforward

- Reduce position error on an axis due to acceleration of another axis

Reduce Vibration at the Work Point

Command Shaping

- Increase throughput
- Faster settle time at the work point
- No additional sensors required
- Reduced vibration in point-to-point moves
- Easy tuning

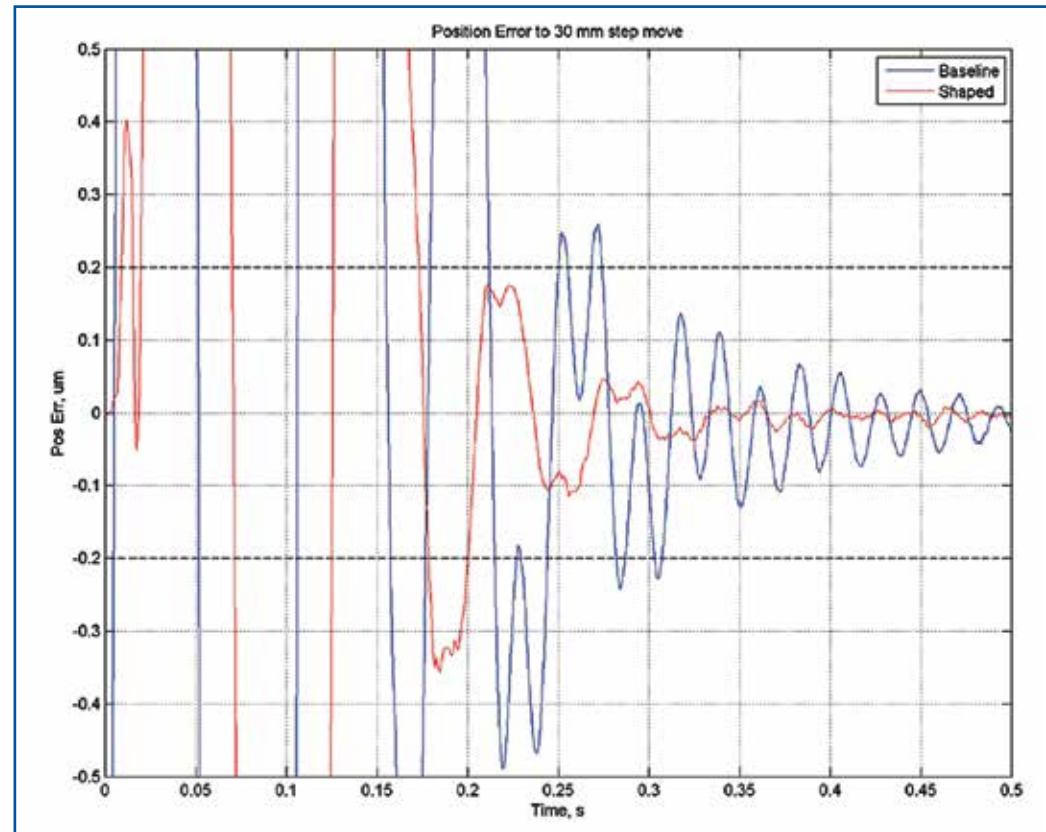

Position error at work point to 30 mm step move

Applications

- Pick and Place Machines
- Semiconductor Inspection
- Genome Sequencing

High Accuracy Firing Based on Actual Calibrated Encoder Counts

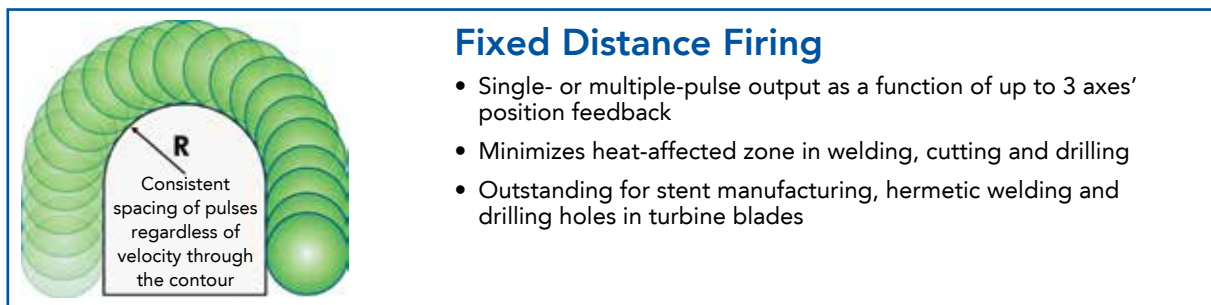
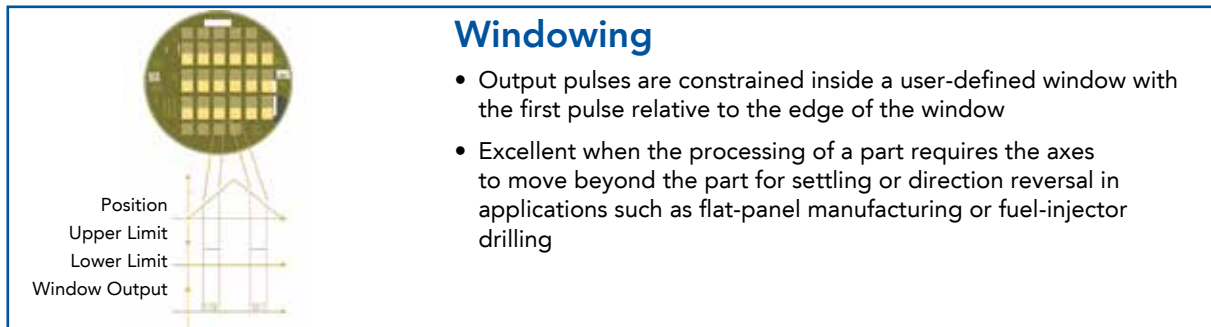
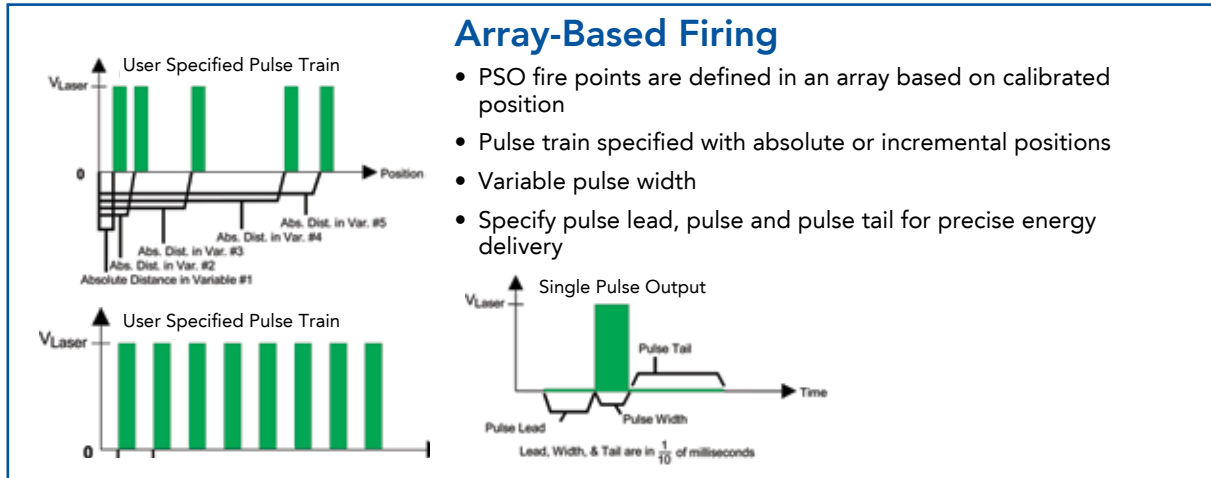

Position Synchronized Output (PSO)

- Increase throughput
- Higher accuracy
- 1-, 2- or 3-axis PSO
- Configurable command pulse train
- Use to trigger
 - Laser firing
 - Camera capture
 - Data acquisition
 - Nondestructive test triggering

Gantry Control

- Both spars are programmed and commanded as a single axis
- Easy homing
- Marker offset for high accuracy
- Orthogonality correction



Gantry Modes

- Current Synchronization
- Position Synchronization

Gantry Configuration

- 2 Motors, 2 Encoders
- 2 Motors, 1 Encoder
- 1 Motor, 1 Encoder

Open architecture, PC-based robot controller for three-axis (X/Y/Z) Delta robots. Includes a pre-configured installation of Aerotech's A3200 automation platform with robot specific programming extensions, NEMA 32 frame size motors, drives, and cables. Key system features include:



Delta Robot Control

- Industrial panel-mount PC with solid-state disk drive
- Teach mode with user defined number of points
- Synchronization with moving material
- Target position command queue of user defined depth
- Real-time simultaneous display of tool and work-point coordinates
- G code and AeroBasic™ motion command syntax
- Control up to 20 additional axes
- Optional IEC 61131-3 PLC interface with support for PLCopen and .NET
- Servomotor with absolute feedback device and brake
- Ndrive CP10 drives
- 5 meter long motor power and feedback cables

Directly Synchronize Scanhead and Servo Motion for Ultimate Flexibility in Marking Applications

Laser Marking– Nmark® CLS

(Closed-Loop Scanner)

- Expand scanner field-of-view without sacrificing effective pixel resolution
- Mark long vectors with one continuous pass
- Draw large-scale graphics without stitching multiple exposures
- Mark on a tube or other irregularly shaped object without manually repositioning
- Single programming environment for both scanner and servo axes minimizes application complexity
- Eliminate angular errors
- Scanner programmed with standard RS-274 G code
- Laser firing based on real-time scanner position

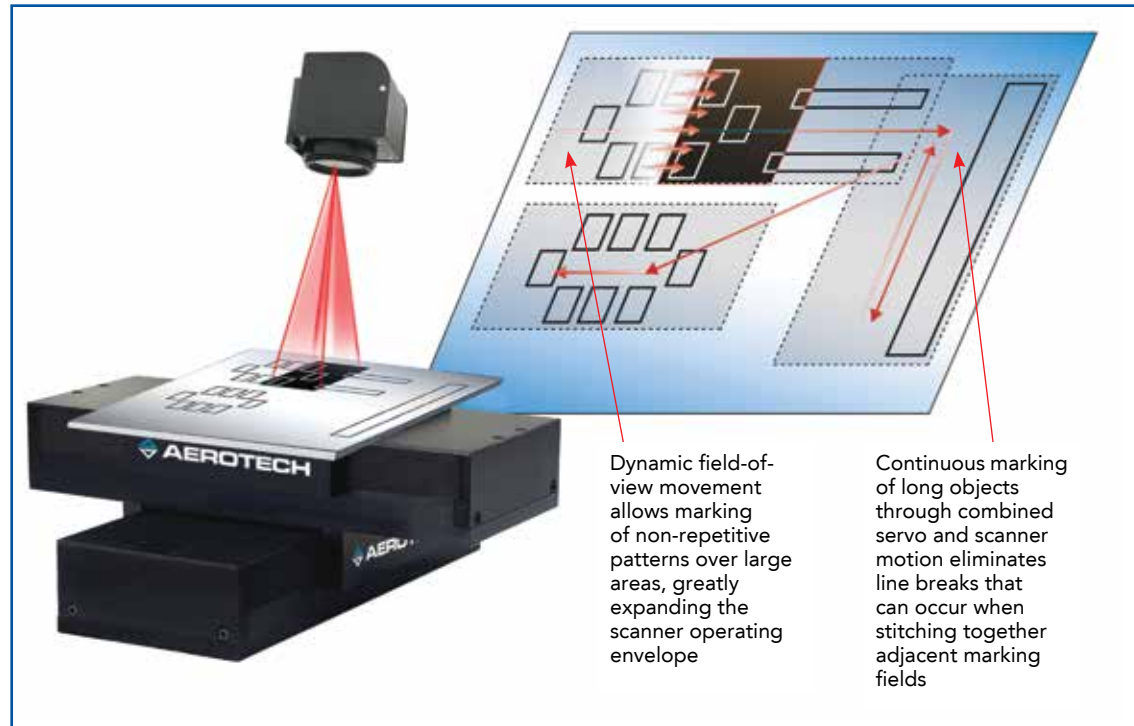



Nmark AGV-HP

- Highest accuracy scanner available attains single-digit, micron-level accuracy over the field of view
- Optical feedback technology significantly improves thermal stability
- Industry-best resolution of >24 bits when used with Aerotech's Nmark GCL controller
- Wide range of apertures and focal lengths



Nmark AGV-HPO

- Highest accuracy scanner available attains single-digit, micron-level accuracy over the field of view
- Optical feedback technology significantly improves thermal stability
- Industry-best resolution of >24 bits when used with Aerotech's Nmark GCL controller
- Wide range of apertures and focal lengths, and many choices of mirror surface treatments for a variety of laser wavelengths



Nmark GCL

- Closed-loop, two-axis servo drive for Aerotech's AGV series scanners
- Infinite Field of View (IFOV) seamlessly combines AGV and servo motion to expand the scanner work area
- Full servo state control with "zero-tracking error" eliminates speed-related part distortion such as necking on circles and rounding of corners
- Position-based laser firing (PSO) with windowing maintains consistent spot spacing over a wide range of operating speeds

High-Performance Galvanometer Scanners

Vector Applications

- Cutting
- Welding
- Sealing
- Ablation
- Marking

Graphic Applications

- Bar Code
- Serialization
- Engraving
- Character Scribing

Friction Compensation

- Reduced settle time
- Reduced error at direction reversals

Advanced Friction Model

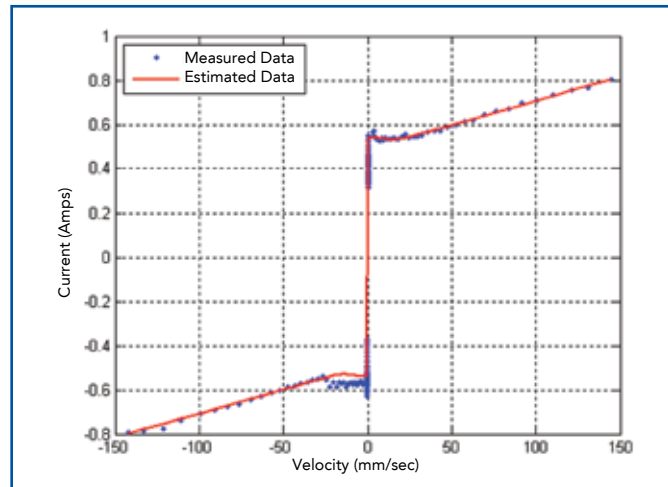

High speed, high accelerations and minimal position error achieved with feedforward additive force

Friction Compensation Results

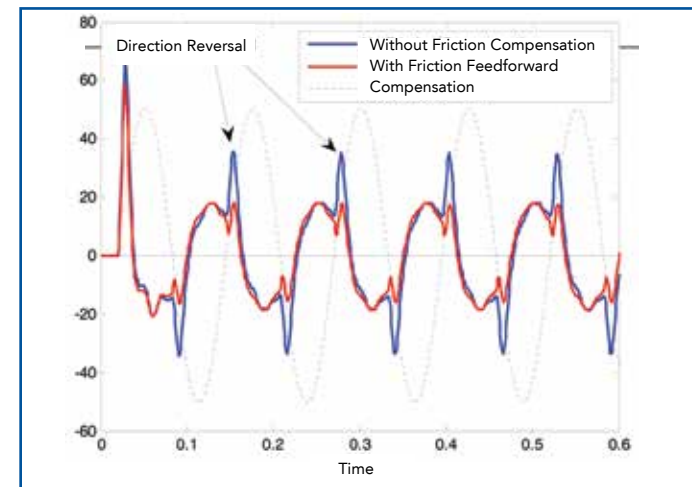

Fieldbus and Networking

Aerotech controllers support a multitude of industry-standard communication protocols to facilitate easy component networking, device connectivity and superior motion system performance.

Networking Type	Plant					Fieldbus						Motion		Drive I/O	
	Ethernet TCP/IP	USB	RS-232	RS-485	OPC*	EtherCAT	EtherNet/IP™	DeviceNet™*	CANopen*	PROFIBUS	Modbus® TCP	FireWire®	Aeronet	Analog	Digital
A3200	✓				✓	✓		✓	✓	✓		✓		✓	✓
Ensemble	✓	✓	✓	✓	✓		✓	✓	✓	✓	✓		✓	✓	✓
Soloist	✓	✓	✓	✓			✓	✓	✓	✓	✓			✓	✓
Summary	Aerotech controllers connect seamlessly to your existing corporate network or PC via these standard protocols.					Aerotech controllers support a variety of fieldbus communication protocols to fit your application.						Aerotech controllers use state-of-the-art communication standards for motion network communication to ensure a robust, high-performance system.		Aerotech drives include a standard complement of on-board analog and digital I/O, with an option for an expanded I/O board.	

*Coming Soon



Fieldbus I/O with Hilscher NetX technology

Corporate networking protocols allow remote control and monitoring of your motion system.

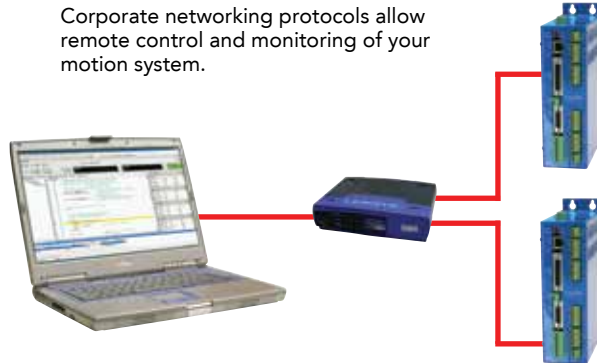

Fieldbus communication protocols provide extensive options for communicating with PLCs and other components in your system.

Aerotech's motion networking architectures are truly plug-and-play, making setup quick and easy.

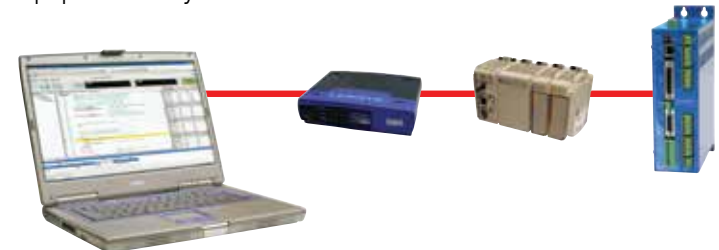

Aerotech's HEX RC

Aerotech's HEX RC is a high-performance, 6-axis motion controller ideal for controlling robotic systems like hexapods. The HEX RC is 4U high, rack-mountable, and compatible with the Automation 3200 (A3200) motion platform. A high-performance processor provides the intense computing power needed to run up to 32 axes, perform complex, synchronized motion trajectories, manipulate I/O, and collect data at high speeds.

- 4U high, rack-mount, six-axis controller for brush, brushless, and stepper motors
- Ideal for controlling six-axis robotic systems like hexapods
- Real-time A3200 distributed control architecture allows synchronized motion on up to 32 axes
- FireWire® or ASCII command interface via TCP/IP
- Optional integrated encoder multipliers for high resolution positioning and reduced integration complexity
- Optional six-axis jog pendant
- Program in native RS-274 G-code, AeroBasic™ command set, C, C++/CLI, .NET, MATLAB®, LabVIEW®, or IEC 61131-3 (LD, FBD, ST) for the ultimate in programming flexibility





Ensemble QL/QLe™

The Ensemble QL/QLe™ panel-mount nanopositioning piezo drive family is designed for seamless use with the Ensemble family of drives and controllers. The QL/QLe connects to any Ensemble controller network enabling coordinated motion between piezo stages and servo axes at much higher rates than other controller or drive products. This power, versatility, and affordability make the Ensemble QL/QLe drives ideal for applications ranging from the most demanding fundamental scientific research to advanced OEM machine systems.

Ensemble QDe™

The Ensemble QDe™ is a high-performance desktop nanopositioning piezo drive designed for seamless use with the Ensemble family of drives and controllers. The QDe connects to any Ensemble controller network enabling coordinated motion between piezo stages and servo axes at much higher rates than other controller or drive products. This power and versatility make the Ensemble QDe ideal for single or multi-axis applications ranging from fundamental scientific research to advanced OEM machine systems.

Ensemble QLAB™

The Ensemble QLAB™ is a high-performance nanopositioning piezo stage controller for 1 to 4 axes of motion. The flexible controller platform allows user-configurable open-loop and closed-loop operation on a per axis basis. Simple software commands allow the user to switch between open-loop and closed-loop if an axis is configured for closed-loop mode.

Controller Comparison Chart

Unsure about which controller is right for your application?

Consult the chart to see which controller fits your needs.

Basic Functions	A3200	Ensemble	Soloist
Multi-Axis	Up to 32 axes coordinated	Up to 10 axes coordinated	Single axis
Architecture	PC-based software controller	Stand-alone	Stand-alone
Number of Tasks	32	4	4
CNC Functionality/RS-274	✓		
Coordinated Motion	✓	✓	
Point-to-Point Motion	✓	✓	✓
Cutter Compensation	✓		
Multi-Block Look-Ahead	✓		
Acceleration Limiting/Look-Ahead	✓		
Gantry Mode	✓	✓	
Velocity Blending	✓	✓	✓
Electronic Gearing	✓	✓	✓
Electronic Cam Profiling	✓	✓	✓
Arbitrary Path Generation	✓	✓	✓
Jog and Offset, Jog and Return	✓		
Velocity Profiling	✓	✓	✓
Retrace (Block by Block)	✓		
Axis Calibration	✓	✓	✓
3D Error Mapping	✓		
Sinusoidal Commutation	✓	✓	✓
Analog Power Control	✓	✓	✓
Servo, Stepper or DC Motor Controller	✓	✓	✓
Expanded IO Available	✓	✓	✓
Encoder Tuning	✓	✓	✓
Dual Loop Control	✓	✓	✓
PLC (IEC 61131-3)	✓		

Advanced Functions	A3200	Ensemble	Soloist
IDE	✓	✓	✓
.NET, AeroBasic™	✓	✓	✓
Fast Position Capture	✓	✓	✓
High-Speed Registration	✓	✓	✓
On the Fly End-Point Modification	✓	✓	✓
Orthogonality Correction	✓	✓	✓
Parts Rotation	✓		
Intra-Block Retrace	✓		
Iterative Learning Control	✓	✓	✓
PSO	Yes, up to 3 axes	Yes, up to 3 axes	Yes
Harmonic Cancellation	✓	✓	✓
Direction Gain Scheduling	✓	✓	✓
Inertial Damping	✓	✓	✓
Friction Compensation	✓		
Linear Drive Amplifiers	✓	✓	✓
Machine Retrofit Hardware Available	✓		
Galvo Integration	✓		
Seven Segment Acceleration Profile	✓	✓	✓
Slice Move	✓		
Corner Rounding	✓		
Coordinate Transformations	✓	With Plug-In	
Kinematics	✓	With Plug-In	
Loop Transmission	✓	✓	✓
Advanced Diagnostics and Tuning	✓	✓	✓
Auto Focus	✓	✓	✓
MATLAB®	✓		
Force Control	✓	✓	✓
Soft Landing	✓	✓	✓
Piezo Nanopositioners	✓	✓	
HexGen Hexapod	✓		
RCP-DELTA Delta Robot	✓		

**Use the Best
Controller
for Your
Application**

- Wired and tested consoles
- Wired panels and 19-inch racks
- Integrated subsystem with PC, controls, drives, cables, power supply or transformer, line filtering, PLC motion, I/O and customer I/O
- CE/UL standards
- Comply with NFPA79 wiring standard

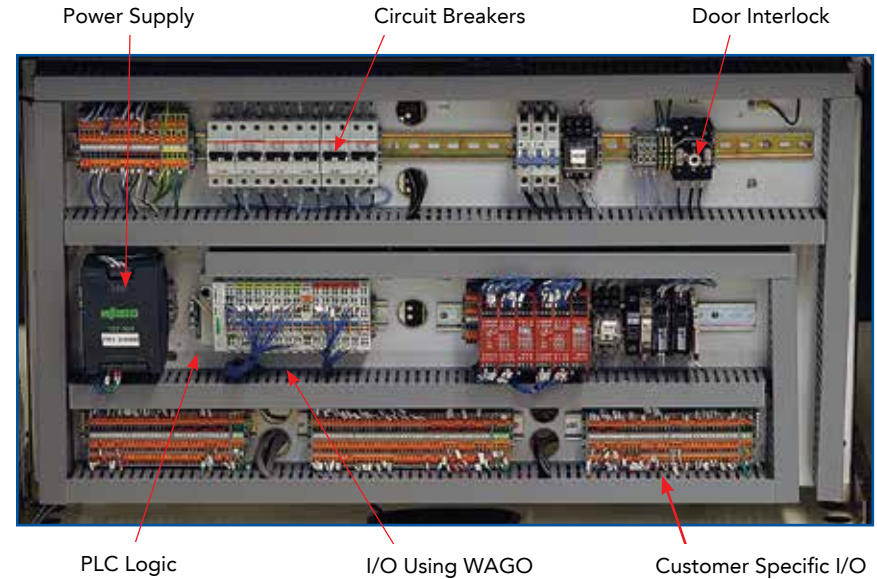

Nsys Complete Consoles

Complete consoles are available that integrate all of the electronics for your system, including the controller, drives and/or drive racks, I/O and monitor.



Aerotech Machine Safety Standards



Safety Level	Fault Detection	Loss of Safety Function Probability	Single Fault Covered	Double Fault Covered	Input ESTOP Signal	Supply Power to Drive
Category B	None	Very High	No	No	No specific design	No specific design
Category 1	None	Very High	No	No	Simple mushroom switch	One relay
Category 2	Low	High	No	No	Simple mushroom switch	One positive guided relay with auxiliary contact for checking
Category 3	Medium	Medium	Yes	No	Dual circuit mushroom with fault detection	Two positive guided relays with cross checking
Category 4	High	Low	Yes	Yes	Dual circuit mushroom with independent fault detection	Two positive guided relays with cross checking

Hardware Options

	MP	CP	HPe	HLe	ML	Integrated Drive Racks		Nservo	Nstep	Nmark™	Console	QL/QLe	
A3200 Drives													
Ensemble Controls								N/A	N/A	N/A	N/A		
Soloist Controls						N/A		N/A	N/A	N/A	N/A	N/A	
Axes	1	1	1	1	1	1 to 8	1 to 8	2 or 4	2 or 4	3	1 to 12		
Output Type	PWM	PWM	PWM	Linear	Linear	PWM and Linear	PWM and Linear	Three-Phase ±10 V	Clock and Direction	Clock and Direction	N/A		
Peak Output Current	10 A	10-30 A	10-150 A	10-20 A	10 A	Npaq: 10-30 A Npaq MR: 10 A Hex RC: 10 A	Epaq/Epaq MR: 10 A Epaq: 10 A Ensemble LAB: 5 A Ensemble QLAB: 300 mA Ensemble QDe: 250 mA	N/A	N/A	N/A	N/A		
DC Bus Voltage	10-80 VDC (Output)	10-320 VDC	10-320 VDC	±40-80 VDC	±40 VDC	Npaq: 10-320 VDC Npaq MR: 10-80 VDC Hex RC: 80 VDC	Epaq: 24-90 VDC; ±10-40 VDC Epaq MR: 10-80 VDC Ensemble LAB: ±24 VDC Ensemble QLAB: -30 to +150 V Ensemble QDe: -30 to +150 V	N/A	N/A	N/A	N/A		
Standard I/O	1-AI	6-DI/4-DO 1-AI/1-AO	6-DI/4-DO 1-AI/1-AO	6-DI/4-DO 1-AI/1-AO	6-DI/4-DO 1-AI/1-AO	Multiple Configurations Available	1-AI per axis	11-DI/8-DO 4-AI/2-AO	16 Assignable IO	N/A	N/A		
Optional I/O	8-DI/8-DO 1-AI/1-AO	16-DI/16-DO 1-AI/1-AO	16-DI/16-DO 4-AI/4-AO	16-DI/16-DO 4-AI/4-AO	16-DI/16-DO 1-AI/1-AO	Multiple Configurations Available	Multiple Configurations Available	Via Optional Ethernet Port	N/A	N/A	N/A		
I/O Spec	12-bit differential AI 16-bit single-ended AO	16-bit differential AI 16-bit single-ended AO				Npaq or HEX RC: Four 16-bit differential AI Two 16-bit single-ended AO Npaq MR: Same as ML or MP per axis		Epaq or Epaq MR: Same as ML or MP per axis Ensemble QLAB: 4 AI, 4 AO Ensemble QDe: 1 16-bit, 1 18-bit	Two 16-bit differential AI Two 16-bit single-ended AO	N/A	N/A	N/A	
Incremental Encoder	✓	✓	✓	✓	✓	✓	✓	✓			✓		
Absolute Encoder		✓	✓	✓			✓	✓			✓		
Resolver/ Inductosyn			✓	✓		✓		✓			✓		
Capacitive Probes					✓	✓							
Laser Interferometer						✓							

All units capable of sinusoidal commutation, dual-loop control and drive brushless, brush, or stepper motor

The BA series amplifiers are Aerotech's stand-alone PWM drive for three-phase AC brushless and single-phase DC brush motors.

BL series amplifiers are highly reliable linear brushless servo amplifiers.



BA PWM Amplifiers

- Wide output power range from 10 A peak to 100 A peak at 320 VDC
- No transformer required; direct connection to AC line
- Capable of running brushless or single-phase DC brush motors
- Velocity, torque and dual-phase mode input command
- Accepts both encoder or tachometer feedback for velocity control
- Can be externally commutated
- UL, CE and CSA approval



BL Linear Amplifier

- Non-switching, high-performance linear operation for ultra-smooth control of brushless motors
- Totally modular design accepts 110 VAC or 220 VAC input power
- Ideal for air-bearing systems and noise-sensitive applications

Rotary Motors

- Ironless/cogless design for superior motion
- Iron-core motors for high force output
- Frameless torque motors for custom machines
- Ultra-precision positioning
- Low heat generation
- Vacuum compatible options
- NEMA 17, 23, 34, 42 and IEC 142

Torque	
Type:	Brushless
Continuous Torque:	0.16 - 31.6 N·m
Peak Torque:	0.48 - 94.9 N·m
Rated Speed:	2400 - 4000 rpm

Torque	
Type:	Brushless, Slotless
Continuous Torque:	0.27 - 2.86 N·m
Peak Torque:	1.07 - 11.43 N·m
Rated Speed:	2000 - 4000 rpm

Torque	
Type:	DC Brush
Continuous Torque:	0.25 - 1.48 N·m
Peak Torque:	1.84 - 7.1 N·m
Rated Speed:	3000 - 6000 rpm

Torque	
Type:	Stepper
Continuous Torque:	0.78 - 11.5 N·m
Peak Torque:	---
Rated Speed:	---

Full line of DC brush, brushless, servo and stepper motors to fit almost any situation. Brushless motors feature neodymium iron boron magnets for maximum torque and acceleration in a small package.



Frameless Rotary Motors

Torque

Type: Frameless
Continuous Torque: 0.20 - 29.09 N·m
Peak Torque: 0.82 - 116.37 N·m
Rated Speed: 200 - 8000 rpm

Five frameless designs for easy integration into OEM machines.

Slotless stator and high-pole-count rotor provide zero cogging for exceptional velocity control.



Brushless Linear Servomotors — Flat and U-Channel

Force

Type: Flat
Continuous Force: 19 - 697 N
Peak Force: 75 - 1507 N

Aerotech's proprietary coil winding technology produces the highest force to volume ratios available.

Direct drive, noncontactingforcer coil eliminates backlash, windup and wear for a maintenance-free system.

Force

Type: U Channel
Continuous Force: 14 - 1063 N
Peak Force: 56 - 4252 N

Linear servomotors are ideal for:

- Robotics
- Packaging
- Actuators
- Tables/Stages
- Assembly
- Fiber Optics/Photonics Alignment and Positioning
- Machine Tools
- Semiconductor Equipment
- Electronic Manufacturing

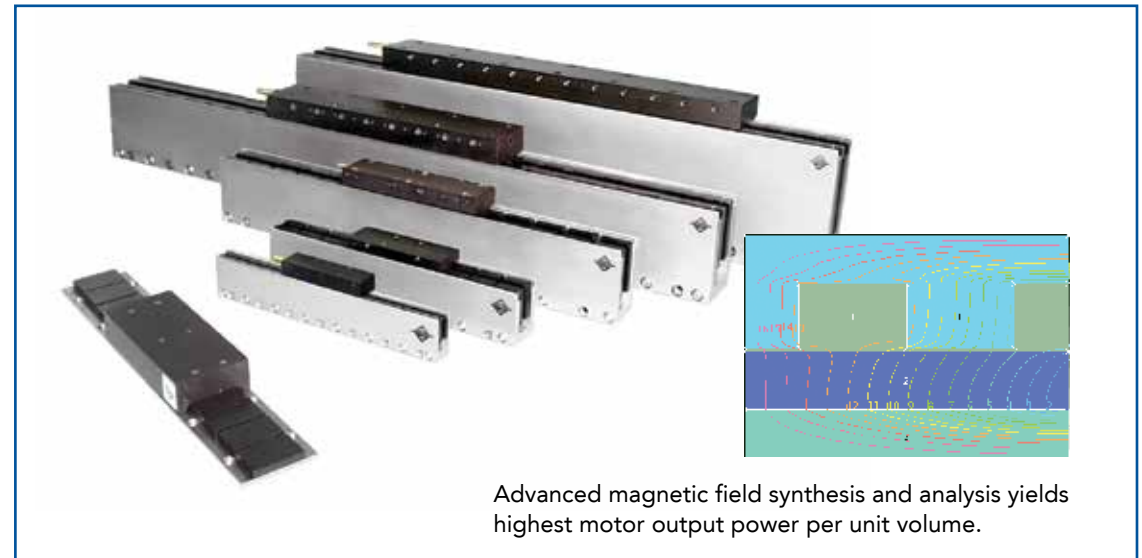

Advanced magnetic field synthesis and analysis yields highest motor output power per unit volume.

Custom Motors

We customize for you

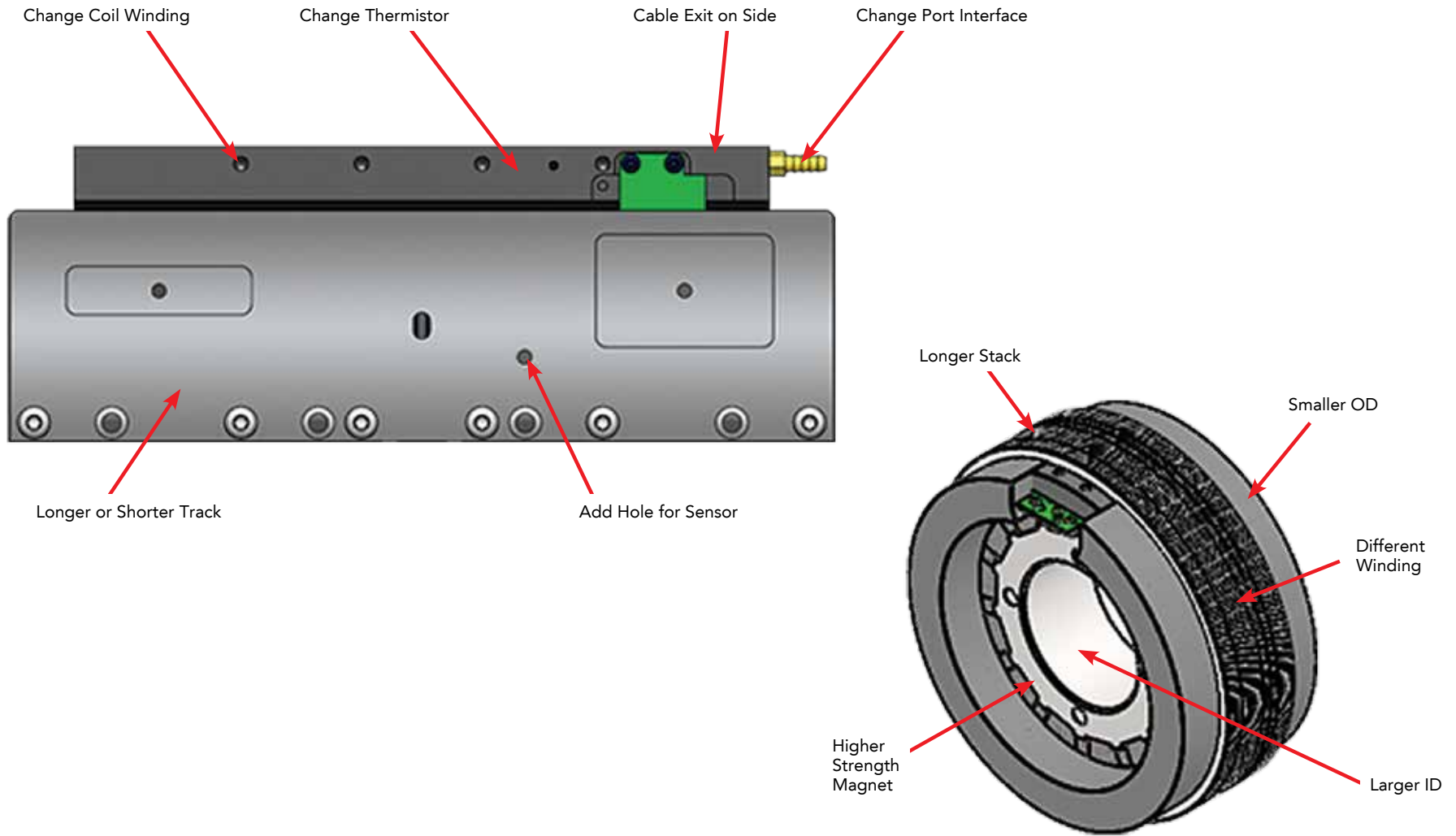

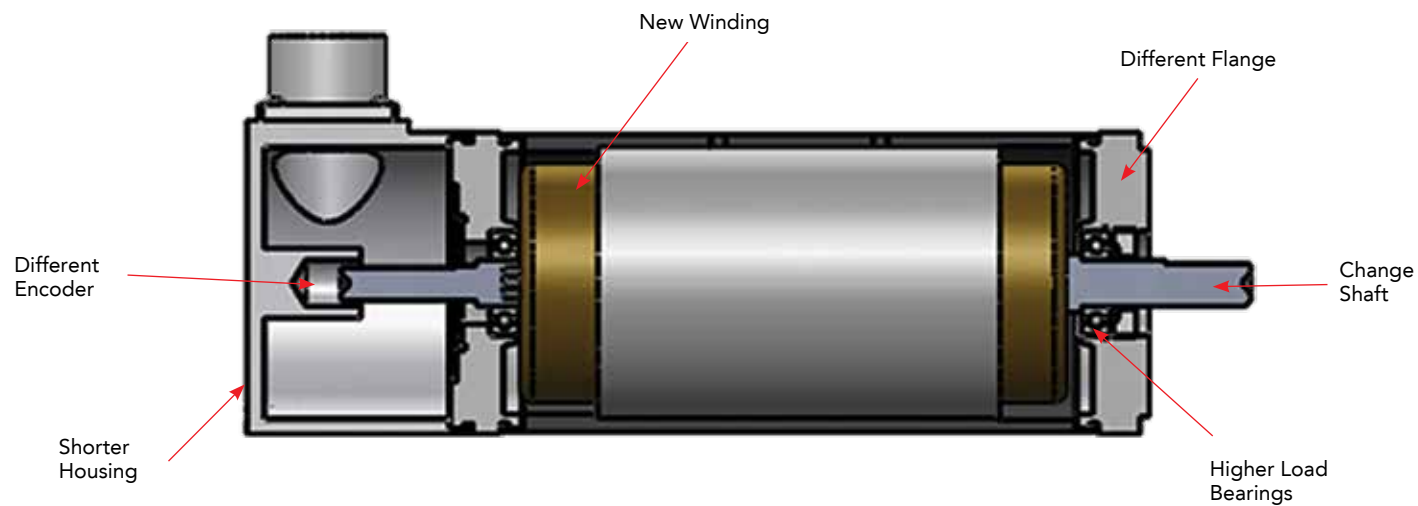
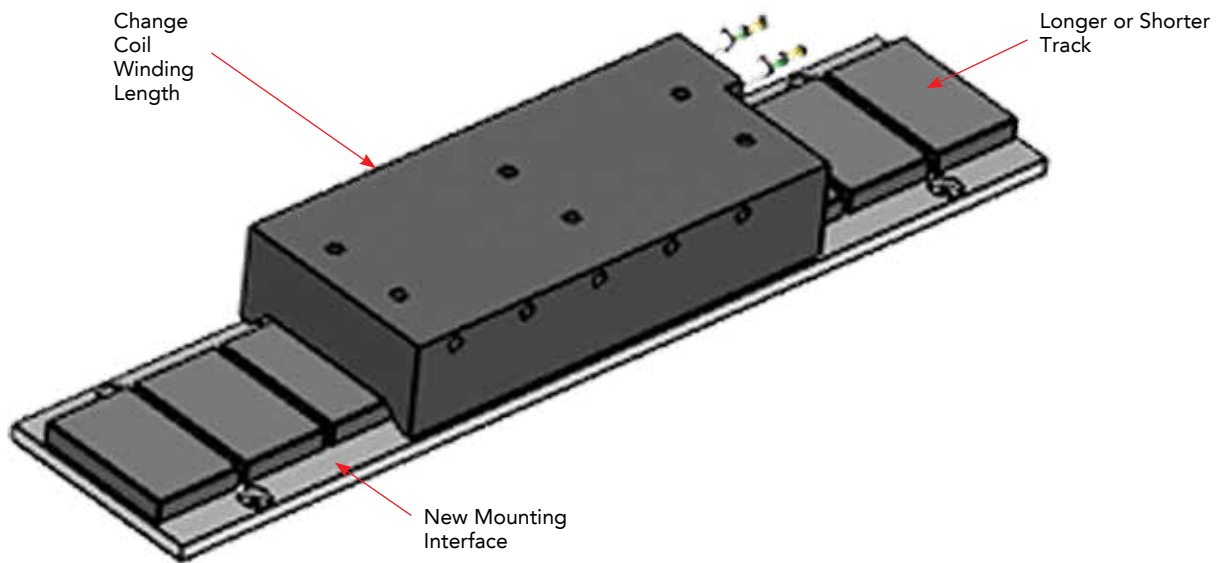

We customize for you...

Hardware • Software • Firmware • Packaging • Motors • HMI • Electronics • I/O

Connectivity

- Ethernet
- Fieldbus
- Wireless
- USB



Custom Automation

- Coordinate motion, PLC, robotics, vision, and communications with one automation control
- Galvo control
- Piezo control
- Integration with process control
- HMI integration

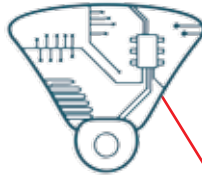

Custom Software

- Custom operator interfaces
- Custom applications
- Custom software libraries
- Program in nearly any language



Vision Integration

- Interface with standard cameras and machine vision systems
- Registration marks or fiducials can be located and used as a home or reference position
- Vision can be coordinated with servo motion for vision guided robotics



$$\frac{T(s)}{D(s)} = \frac{s^2 \prod (s^2 + \omega_i^2)}{s^2 \prod (s^2 + \omega_i^2) + [\sum x_n \frac{(b_n s + k_n)}{(s^2 + \omega_n^2)}] \prod (s^2 + \omega_i^2)} \delta_n(s)$$

Custom Control Algorithms

- Create algorithms at the application, motion engine, firmware, or hardware layer
- Flexible control architecture
- Custom kinematics

Custom Drives

- Plug-in architecture speeds development of custom algorithms – for example, 2D bar code, interfaces to non-standard sensors, and signal outputs synchronized to servo sample time
- Packaging can be customized for specific form factor and space constraints
- Custom algorithms can be developed at the firmware layer

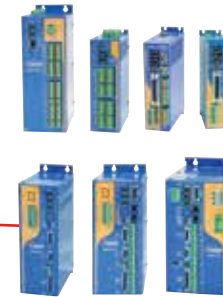

Custom Motor Design

- Custom motors optimized for your specific application at a minimal price
- Customized motor mechanical characteristics including torque/force, length, width, height
- Customized motor electrical characteristics including bus voltage, resistance, inductance, pole pitch, and current
- Custom motors for low-volume projects
- Completely new motor design



We implement with you...

Tuning • Parameters • Optimize Performance • HMI • Write Software

We will work with you onsite or at our facility to meet your machine specifications.



Aerotech personnel will:

- Perform parameter setup and system tuning
- Setup of the Advanced Controls Toolbox to achieve the highest performance possible
- Write motion programs in AeroBasic™
- Write software (.NET, C) by applying our libraries
- Write PLC programs using Ladder, Function Block, or Structured Text
- Product customization
- Product application
- Write/configure HMIs
- Integration with process controller

Benefits include:

- Maximize machine performance
- Minimize machine development time
- Minimize cost



Accessories

Available Accessories:

Maple
Operator
Interface

Joystick
Handwheel/
Pendant

Transformers
Power Supplies

Cables
Automation

Server
MXH Multiplier
Boxes

Line Filters
Panel PC



Markets and Industries



Laser Processing
Semiconductor Processing
Military and Aerospace
Electronics Manufacturing
Medical Device Manufacturing
Test and Inspection

Machine Tools
Automotive
Packaging
University Research
Industrial R&D
Photovoltaic Manufacturing



Aerotech controls and components have become the preferred solution for a variety of applications in a host of industries around the world.

Aerotech Customer Applications

- Labeling
- Web Applications
- Case Erectors

A3200

- Stencil Cutting
- Wire Bonding
- Die Bonding
- Optics Polishing
- Stent Manufacturing
- e-Beam Welding
- EDM
- Drilling and Milling
- Grinding and Polishing
- Waterjet Cutting
- Fuel Injector Drilling
- Fuel Cell Manufacturing
- Crystallography
- Target Tracking
- Beam Steering
- Pipe Thread Measurement

A3200 or Ensemble

- Dispensing (Printed Electronics, Material Dispensing)
- PCB Assembly (Pick and Place of SMT, Through-Hole)
- VIA Drilling
- Wafer Scribing and Singulation (Dicing)
- Die Bonding
- Resistor Trimming
- AOI/X-Ray Inspection
- Chip Testing
- Chip Packaging
- Crystallography
- Flat Panel
- Semiconductor Testing
- Semiconductor Manufacturing
- Photovoltaic Cell Manufacturing
- DNA Analysis
- Image Duplication
- Holographic Writing
- Sensor Testing
- Sensor Manufacturing

Ensemble

- Packaging Machines (Multi-Axis Applications)
- Web Applications
- Printing Applications
- Rollover Unit Testing
- IMU Testing
- ECM
- Marking
- Vertical Form, Fill, and Seal

Soloist

- EDM & ECM
- Packaging Machines (Case Erectors, Labeling Machines, Augers)
- Printing
- Gyro Testing
- Accelerometer Testing
- Optical Polishing (Spindle Axis)
- Beam Steering

Stent and Medical Device Manufacturing

Aerotech's experience in market-specific solutions provides an edge in processes involving photonics, semiconductor processing, medical device manufacturing and laser processing. With a number of specially developed motion platforms for these industries, Aerotech provides a one-stop-shop for your motion requirements.

Controllers to Use:

- A3200

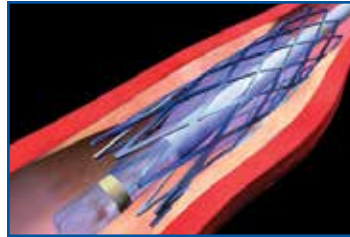

Aerotech's highly successful VascuLathe® and LaserTurn® platforms deliver maximum productivity in a compact, easy to maintain package with the lowest cost of ownership in the industry. With the A3200's PSO functionality, the throughput possible with the LaserTurn® and VascuLathe® series is unmatched.



- Laser Cutting
- Welding
- Wafer Dicing
- Solar Panel Scribing
- Fuel Injector Drilling
- Turbine Blade Inspection



Solar Panel Scribing

Extensive application experience and a broad array of motion products make Aerotech the perfect partner for your photovoltaic (solar cell) manufacturing or testing platform. Our worldwide operation has engineered and manufactured a multitude of motion platforms for solar cell manufacturing and inspection. These platforms range from small format systems for R&D to full-size production panel processing systems.

Controllers to Use:

- A3200
- Ensemble



- Fuel Cell Manufacturing
- 3D Laser Processing
- MRI Machines
- Lab Automation
- Target Tracking
- Optical Testing

Packaging

Line following applications including:

- Labeling, cut-to-length, fly cutting, lane diversion, rotary knife and many others.

Basic features for line following:

- Auxiliary encoder input for measuring line speed
- High-speed registration for measuring line position
- The relationship between line speed/ position can be an arbitrary function or simply 1-to-1

Controllers to Use:

- Soloist
- Ensemble
- A3200

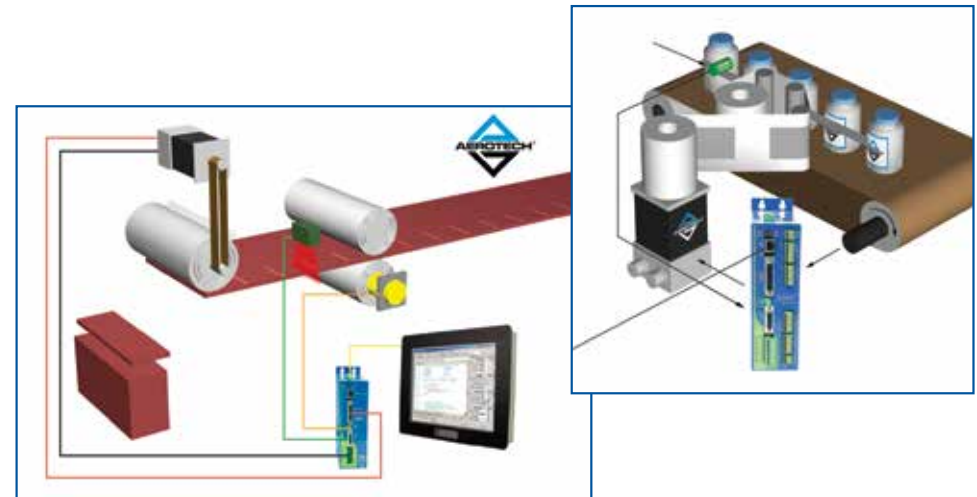

High Accuracy, Multi-Axis Inspection Systems

The A3200 controller is uniquely suited to complex inspection applications like turbine blade inspection that requires 5 axes or more of coordinated motion integrated with a sensor or camera.

Controllers to Use:

- A3200 with linear drives

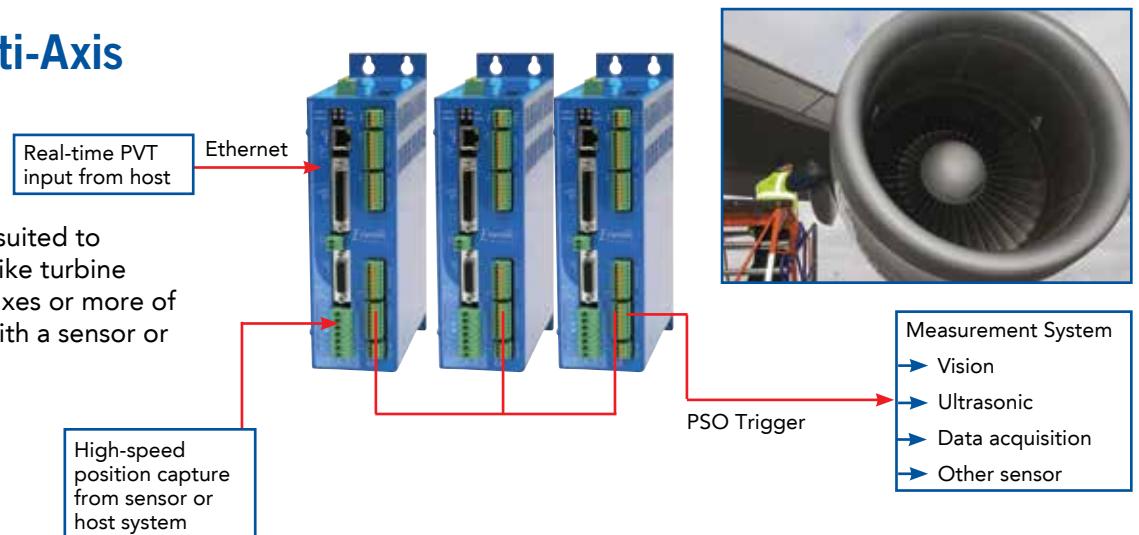

Optical Mounts and Gimbals

- Directing optics, lasers or antennas
- LOS target tracking
- Precision pointing

Controllers to Use:

- A3200
- Ensemble



- Gyro Testing
- Reticle Inspection
- Lithography
- Wafer Defect Detection
- Thin Film Measurement
- Pick and Place



Fuel Cell Manufacturing Operations

- Laser machining the membranes (also referred to as MEAs)
- Welding the plates/membranes together
- Stacking the membranes into a cell
- Inspection of the MEAs, plates and cells

Controllers to Use:

- A3200

Controls Timeline

With 46 years in the business of designing and building motion systems, Aerotech has the experience and knowledge to understand the challenges and solutions of industrial and laboratory processes.

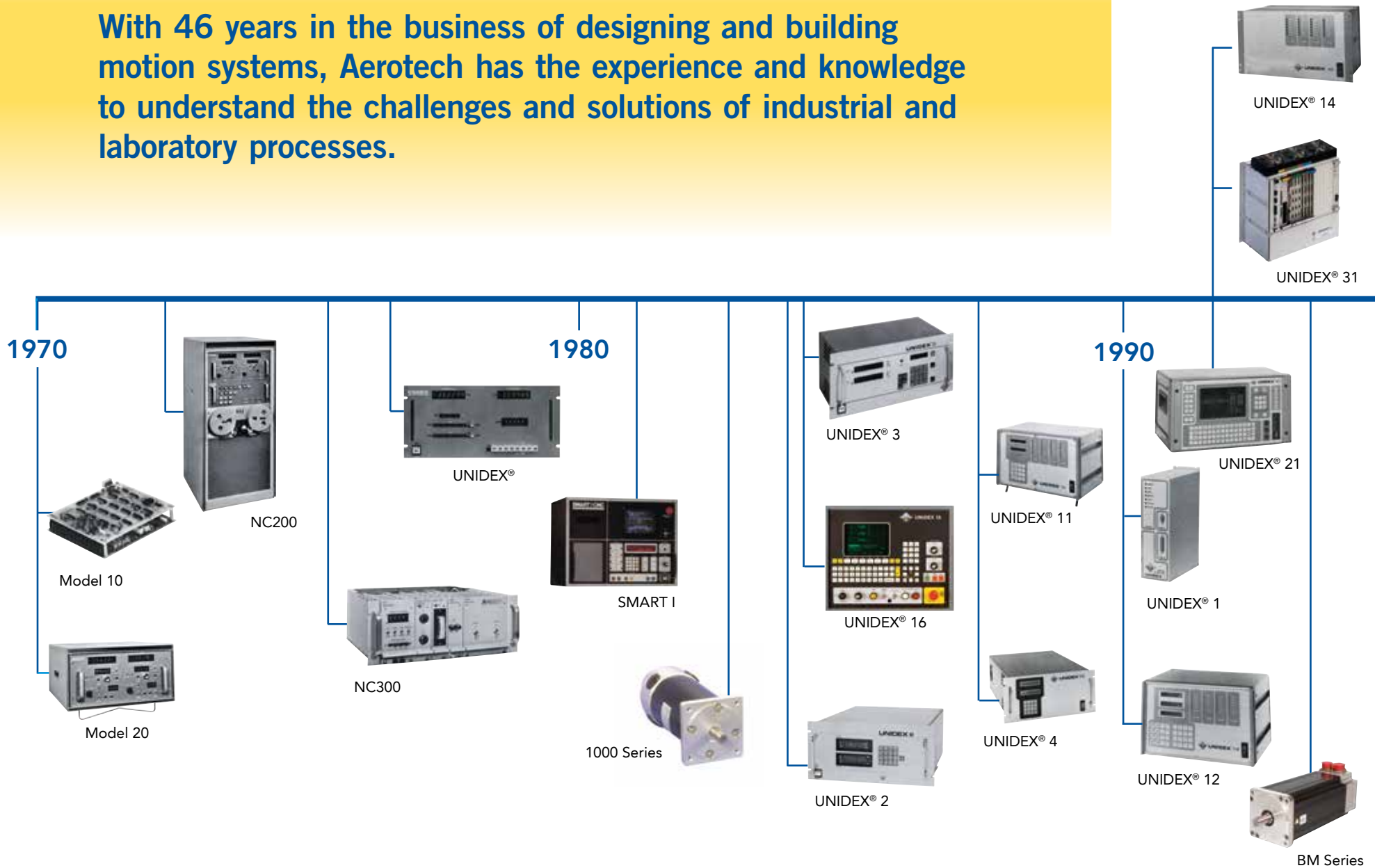



UNIDEX® 500



BLM Series



UNIDEX® 600



A3200



Integrated Automation
PLC + Motion = MotionPAC

PC-Based



Delta
Robot
Control

2000



UNIDEX® 400



UNIDEX® 511



Soloist

2010



Ensemble



Piezo Controls

2016



Hexapod
Control

Stand-Alone



UNIDEX® 100



BAI



BMS Series



S Series

Aerotech has manufactured advanced motion controllers since 1970. From the industry workhorse PCI cards to state-of-the-art software-based control coupled with intelligent networked drives, the science of motion control has been our business for decades.

Aerotech offers comprehensive worldwide training and customer service at customer facilities or at one of our Aerotech training centers.

Training Program:

- Standard and customized courses
- Hands-on training with Aerotech controllers
- Interactive training with experienced instructors
- Comfortable, spacious facilities
- Online training modules
- Online FAQs
- At customer site or at Aerotech

Installation and Startup (Commissioning)

Aerotech offers startup and commissioning services to minimize startup times, reduce costs and accelerate time-to-production. By combining our product knowledge with your process and application expertise, new systems and applications can be completed faster and at a reduced overall cost.

Engineering Support

Aerotech provides complete engineering support for our products, including onsite support and maintenance, and remote support via phone, fax, website and/or WebEx® software. As a manufacturer staffed by engineers, we understand the unacceptability of downtime.

Join.Me.

Aerotech can remotely support your startup, commissioning and debugging of systems over the internet.

Aerotech is an ISO 9001 Registered Company



Aerotech U.S.A.



Aerotech Germany



Aerotech United Kingdom



Aerotech Japan

Since 1995, Aerotech's quality system has been certified to the ISO 9001 standard. The ISO 9001 standard encompasses the Aerotech organization through manufacturing.

As part of our commitment to the ISO standard, we formally survey our customers on a monthly basis which provides valuable feedback to continually improve our products and processes.

Aerotech at a Glance

High-Volume Manufacturing



Over 100,000 axes installed worldwide

This section displays three types of Aerotech components: a stack of linear motor stages at the top, a set of four ADRT rotary stages in the middle, and a large stack of A3200 motion controller units at the bottom.

Worldwide Service and Support



Worldwide startup service and on-site training



Aerotech Worldwide



Fully equipped on-site training facilities

This section illustrates global service and support. It features a technician performing on-site training, a world map with the Aerotech Worldwide logo, and a fully equipped training room with tables and chairs.

Technically Superior Components



Highest performance brushless linear and rotary motors



ADRT rotary stages



ALS1000 linear motor stage



A3200



Soloist®



Ensemble®

Award-winning Automation 3200
1-32 axis motion, vision, PLC, robotics
and I/O platform

This section showcases technically superior components. It includes a collection of brushless linear and rotary motors, ADRT rotary stages, and an ALS1000 linear motor stage. It also features three Automation 3200 products: the A3200 motion controller box, the Soloist motion controller, and the Ensemble motion controller. The Ensemble controller is described as an award-winning platform for 1-32 axis motion, vision, PLC, robotics, and I/O.

High Performance Sub-Assemblies



XYAB subsystem for high dynamic accuracy positioning in laser drilling and micromachining applications

HexGen high-load, ultra-precision hexapod provides unmatched performance

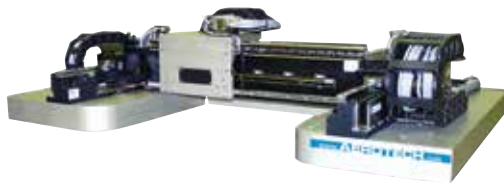

Highest throughput linear motor Cartesian gantry systems

Best-in-Class Subsystems

Highly integrated motion subsystems with machine frame, display and packaged electronics



Custom-engineered, vacuum and cleanroom compatible systems



RCP-DELTA robot capable of 15g's of acceleration and up to 200 pick and place operations per minute



Comprehensive Technical Support Services



Custom software application support

3D models to facilitate faster and more accurate system layout

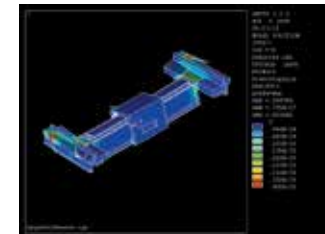
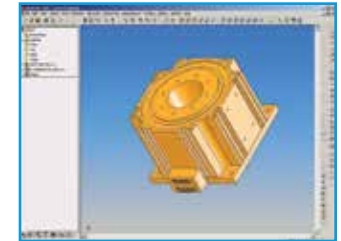

Advanced analytical techniques for optimization of system geometry

Aerotech Worldwide



Corporate Headquarters • Pittsburgh, PA • USA



Aerotech UK



Aerotech Germany



Aerotech Japan



Aerotech China



Aerotech Taiwan

Aerotech Thailand

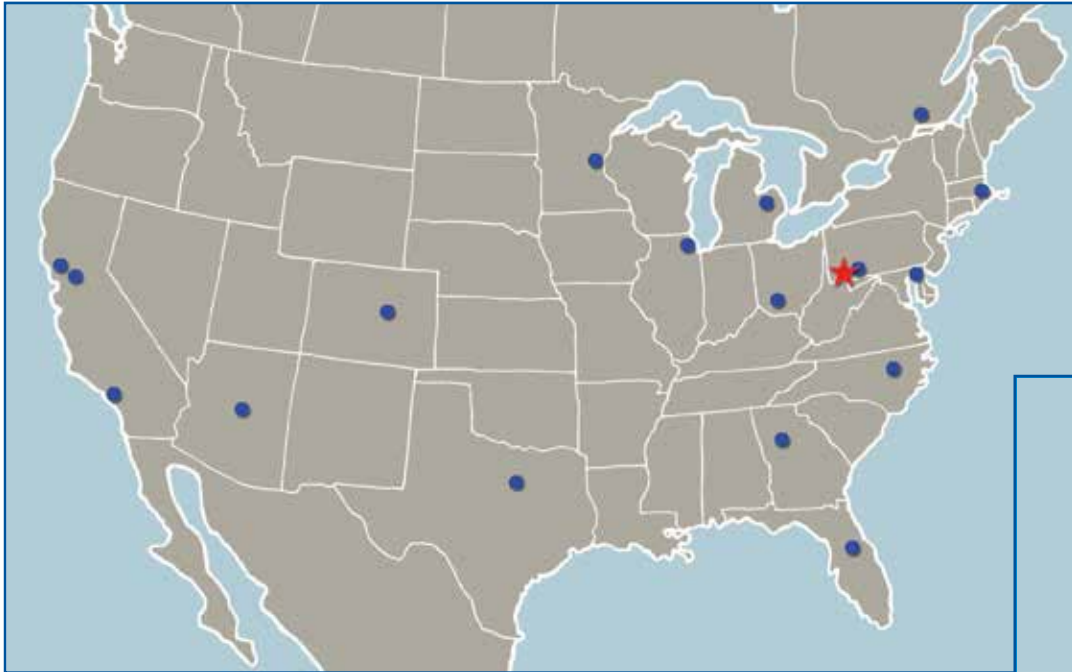

- ★ Aerotech Headquarters
- Direct Field Sales Office
- ▲ Aerotech Subsidiary
- Representative



www.aerotech.com