



HexGen[®] HEX150-140HL Miniature Hexapod Six-DOF Positioning System

HARDWARE MANUAL

Revision 2.00



GLOBAL TECHNICAL SUPPORT

Go to the [Global Technical Support Portal](#) for information and support about your Aerotech, Inc. products. The website supplies software, product manuals, Help files, training schedules, and PC-to-PC remote technical support. If necessary, you can complete Product Return (RMA) forms and get information about repairs and spare or replacement parts. To get help immediately, contact a service office or your sales representative. Include your customer order number in your email or have it available before you call.

This manual contains proprietary information and may not be reproduced, disclosed, or used in whole or in part without the express written permission of Aerotech, Inc. Product names mentioned herein are used for identification purposes only and may be trademarks of their respective companies.

Copyright © 2020-2021, Aerotech, Inc., All rights reserved.



Table of Contents

HexGen® HEX150-140HL Miniature Hexapod Six-DOF Positioning System	1
Table of Contents	3
List of Figures	4
List of Tables	5
Safety Procedures and Warnings	7
EU Declaration of Incorporation	9
Chapter 1: Overview	11
1.1. Environmental Specifications	12
1.1.1. Accuracy and Temperature Effects	12
1.2. Basic Specifications	13
1.3. Understanding Basic HEX150-140HL Operation	14
1.3.1. Hexapod Axes	14
1.3.2. Strut Limits and Hexapod Range	14
1.3.3. Homing	15
Chapter 2: Mechanical Specifications and Installation	17
2.1. Unpacking and Handling the Hexapod	17
2.2. Dimensions	18
2.3. Securing the Hexapod to the Mounting Surface	19
2.4. Attaching the Payload to the HEX150-140HL	21
Chapter 3: Electrical Specifications and Installation	23
3.1. Motor and Feedback Connectors	24
3.2. Motor and Feedback Wiring	26
3.3. Motor and Feedback Specifications	27
3.4. Machine Direction	29
3.5. Feedback Phasing	30
Chapter 4: Maintenance	31
4.1. Service and Inspection Schedule	31
4.2. Cleaning and Lubrication	31
4.3. Troubleshooting	32
Appendix A: Warranty and Field Service	33
Appendix B: Revision History	35
Index	37

List of Figures

Figure 1-1: HEX150-140HL Callouts	11
Figure 1-2: Axis Orientation	14
Figure 2-1: HEX150-140HL Dimensions	18
Figure 2-2: Mounting Hole Locations	20
Figure 2-3: HEX150-140HL Vertical Load Capabilities	21
Figure 2-4: HEX150-140HL Horizontal Load Capabilities	22
Figure 3-1: Motor and Feedback Wiring	26
Figure 3-2: Machine Direction	29
Figure 3-3: Encoder Phasing Reference Diagram (Standard)	30

List of Tables

Table 1-1: Model Options 11

Table 1-2: Environmental Specifications 12

Table 1-3: HEX150-140HL Series Specifications 13

Table 2-1: Stage to Mounting Surface Hardware 20

Table 3-1: Motor and Feedback Connector Pinout 25

Table 3-2: Mating Connector Part Numbers 25

Table 3-3: Encoder Specifications 27

Table 3-4: Limit Switch Specifications 27

Table 3-5: HEX150-140HL Motor Specifications 28

Table 3-6: HEX150-140HL Rotary Encoder Specifications 28

Table 4-1: Grease Specifications 31

Table 4-2: Troubleshooting 32

This page intentionally left blank.

Safety Procedures and Warnings

IMPORTANT: This manual tells you how to carefully and correctly use and operate the HEX150-140HL.









- Read all parts of this manual before you install or operate the hexapod or before you do maintenance to your system.
- To prevent injury to you and damage to the equipment, obey the precautions in this manual.
- All specifications and illustrations are for reference only and were complete and accurate as of the release of this manual. To find the newest information about this product, refer to www.aerotech.com.

If you do not understand the information in this manual, contact Aerotech Global Technical Support.

IMPORTANT: This product has been designed for light industrial manufacturing or laboratory environments. If the product is used in a manner not specified by the manufacturer:

- The protection provided by the equipment could be impaired.
- The life expectancy of the product could be decreased.

Safety notes and symbols are placed throughout this manual to warn you of the potential risks at the moment of the safety note or if you fail to obey the safety note.

-  The voltage can cause shock, burn, or death.
-  You are at risk of physical injury.
You could damage the hexapod.
-  A surface can be hot enough to burn you.
-  Strong magnets and electromagnetic fields are present.
-  While the stage is in motion, you are in danger of receiving pinch, shear, or crush injuries.
-  You could receive an injury if you do not lift the product safely.
You could damage the product if you do not lift and move the product safely.
-  Unsecured cables could cause you to:
 - trip and fall
 - drag the product off of its mounting location
 - damage the cable connections.
-  A blue circle symbol is an action or tip that you should obey. Some examples include:
 - General tip
 - Read the manual/section
 - Wear protective safety equipment (eye protection, ear protection, gloves)
 - If applicable, do not lift unassisted



DANGER: To decrease the risk of electrical shock, injury, death, and damage to the equipment, obey the precautions that follow.

- Electrical installation must be done by qualified personnel.
- Before you do maintenance to the equipment, disconnect the electrical power.
- Before you connect wires to this product, disconnect the electrical power.
- Do not connect or disconnect electrical components, wires, and cables while this product is connected to a power source.
- Restrict access to the hexapod when it is connected to a power source.
- Make sure that all components are grounded correctly and that they obey the local electrical safety requirements.
- Supply each operator with the necessary protection from live electrical circuits.
- Install the necessary precautions to supply safety and protection to the operator.
- It is the responsibility of the system integrator or qualified installer to determine and meet all safety and compliance requirements when they integrate the HEX150-140HL into a completed system.



DANGER: PINCH POINT! Keep Hands Clear while the stage is in motion.



WARNING: To prevent damage to the equipment and decrease the risk of electrical shock and injury, obey the precautions that follow.

- Only trained operators should operate this equipment.
- Use this product only in environments and operating conditions that are approved in this manual.
- Make sure that the product is securely mounted before you operate it.
- All service and maintenance must be done by approved personnel.



WARNING: Securely mount and position all system cables.



IMPORTANT: Carefully lift, move, and transport this product.

EU Declaration of Incorporation

Manufacturer: Aerotech, Inc.
101 Zeta Drive
Pittsburgh, PA 15238-2811
USA

herewith declares that the product:

HEX150-140HL

is intended to be incorporated into machinery to constitute machinery covered by the Directive 2006/42/EC as amended;

and that the following harmonized European standards have been applied:

EN ISO 12100:2010

Safety of machinery - Basic concepts, general principles for design

EN 60204-1:2010

Safety of machinery - Electrical equipment of machines - Part 1: General requirements

and further more declares that

it is not allowed to put the equipment into service until the machinery into which it is to be incorporated or of which it is to be a component has been found and declared to be in conformity with the provisions of the Directive 2006/42/EC and with national implementing legislation, for example, as a whole, including the equipment referred to in this Declaration.

This is to certify that the aforementioned product is in accordance with the applicable requirements of the following directive(s):

2011/65/EU
EU 2015/863

RoHS 2 Directive
Amendment RoHS 3 Directive

**Authorized
Representative**



/ Simon Smith, European Director

Aerotech Ltd
The Old Brick Kiln, Ramsdell, Tadley
Hampshire RG26 5PR
UK

**Engineer Verifying
Compliance**



/ Alex Weibel

Aerotech, Inc.
101 Zeta Drive
Pittsburgh, PA 15238-2811
USA
12/21/2021

Date



This page intentionally left blank.

Chapter 1: Overview

The **base** of a hexapod has a flat mounting surface on the bottom and holds electronics for the hexapod. The base should be mounted to a flat, rigid mounting surface (refer to [Section 2.3](#)). The **base joints** allow the attached strut to pivot from the base.

The **platform** is the moving plate of a hexapod. The threaded holes on the top surface are designed to hold customer equipment (refer to [Section 2.4](#)). The **platform joints** allow the attached strut to pivot from the platform.

The six **struts** of a hexapod change length in order to control the position of the platform. The struts attach only to the joints of the base and platform.

The **cables** exit out of the back of the base. These six cables connect the hexapod to the controller (refer to the [Section 3.2](#)).

Figure 1-1: HEX150-140HL Callouts



Table 1-1: Model Options

HexGen® HEX150-140HL Hexapod 6-DOF Positioning System	
HEX150-140HL	Six degree-of-freedom hexapod positioning system; 150 mm diameter base; 140 mm height at mid-travel; high-load capacity version
Customization	
Contact Aerotech for details about additional customization options.	

1.1. Environmental Specifications



WARNING: Use this product only in environments and operating conditions that are approved in this manual.

Table 1-2: Environmental Specifications

Ambient Temperature	Operating: 10° to 35° C (50° to 95° F) Deviation in temperature can result in performance degradation.
	Storage: 0° to 40° C (32° to 104° F) in original shipping packaging
Humidity	Operating: 20% to 60% RH
	Storage: 10% to 70% RH, non-condensing in original packaging. The machine should be packaged with desiccant if it is to be stored for an extended time.
Altitude	Operating: 0 m to 2,000 m (0 ft to 6,562 ft) above sea level Contact Aerotech if your specific application involves use above 2,000 m or below sea level.
Vibration	Use the system in a low vibration environment. Excessive floor or acoustical vibration can affect system performance. Contact Aerotech for information regarding your specific application.
Protection Rating	Not suited for dusty or wet environments (IP30 equivalent ingress protection rating).
Use	Indoor use only.

1.1.1. Accuracy and Temperature Effects

Aerotech products are designed for and built in a 20°C environment. Moderate temperature changes will affect the accuracy while extreme temperature changes could cause damage to the machine. At a minimum, the environmental temperature must be controlled to within 1°C per hour to ensure the safety of the hexapod. The severity of temperature effects on all specifications depends on many different environmental conditions, including how the hexapod is mounted. Contact the factory for more details.

1.2. Basic Specifications

Table 1-3: HEX150-140HL Series Specifications

	X	Y	Z	A (θx)	B (θy)	C (θz)
Travel ⁽¹⁾	40 mm	40 mm	16 mm	16°	16°	40°
Resolution (Minimum Incremental Motion)	20 nm			0.2 μrad (0.04 arc sec)		
Bidirectional Repeatability, pk-pk ^(2,3)	±1.5 μm	±1.5 μm	±0.4 μm	±15 μrad (±0.04 arc sec)		
Unidirectional Repeatability, pk-pk	±0.75 μm	±0.75 μm	±0.15 μm	±7.5 μrad (±1.5 arc sec)		
Maximum Speed ⁽⁴⁾	20 mm/s	20 mm/s	8 mm/s	10°/s	10°/s	30°/s
Load Capacity, All Positions ⁽⁵⁾	Vertical	7.5 kg				
	Horizontal	2 kg				
Holding Capacity, De-Energized ⁽⁶⁾	10 kg					
Stage Mass	2.3 kg					
Material	Anodized Aluminum Platform and Base; Steel Used in Joints and Inside Struts					
1. Travels are mutually-exclusive. Consult the HexGen® Hexapod Sizer on the Aerotech website for detailed workspace sizing. 2. Measured with single-axis moves at a height of 50 mm above the moving platform. Results can be payload and workpoint dependent. 3. X, Y, Z performance certified as standard. 4. Requires the selection of an appropriate amplifier with sufficient voltage and current. 5. Centered loading (refer to Section 2.4.). 6. Horizontal base plate, centered loading (refer to Section 2.4.).						

1.3. Understanding Basic HEX150-140HL Operation

1.3.1. Hexapod Axes

The hexapod platform can be actuated in six degrees of freedom by changing the lengths of the six struts that connect the platform to the base. Since the axes of motion are not obvious from the mechanics of the hexapod, the axis convention is outlined below. These axes can be used to orient the hexapod in the global workspace. Refer to the HexGen® Programming Guide for more information about controlling hexapod motion. To get a copy of this guide, go to the [Resources](#) section of www.aerotech.com. Select the **Manuals and Help Files** tab. Then download **Hexapod Programming User Guide** from the **User Guides** category.

The six axes include 3 translational axes, X, Y, and Z, and 3 rotational axes, A, B, and C. As shown in the overview, the cables exit out of the back of the base. The positive direction of the X axis goes to the right when looking at the front of the hexapod, and the Z axis goes up vertically. The Y axis goes toward the back of the hexapod. Rotational axes are oriented in the same direction as the translational axes, and positive rotation is clockwise when looking in the direction of the axis. The A axis rotates about the X axis, B rotates about the Y axis, and C rotates about Z. The control software enables the user to customize the coordinate system with certain restrictions. Please refer to the HexGen Programming guide for details regarding coordinate system manipulation.

Figure 1-2: Axis Orientation

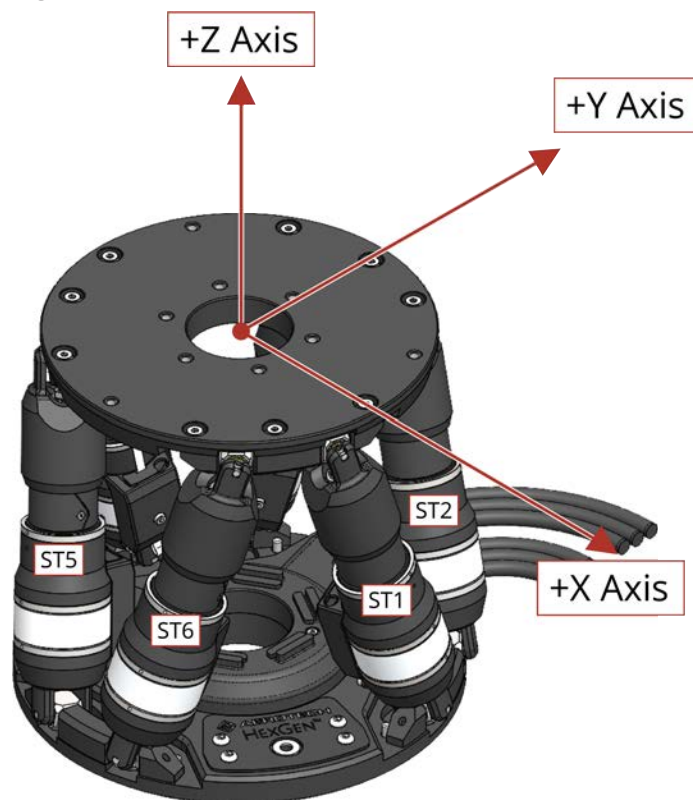

1.3.2. Strut Limits and Hexapod Range

Limits on the strut keep the strut within the useable travel range. When any strut has reached the end of travel in either direction, an error will occur in the controller. Because the ranges of the hexapod axes are interdependent, the limits of the hexapod axes are not constant, and the range of motion of a hexapod cannot be concisely described. Refer to [Section 1.2.](#) for the independent travel of each hexapod axis and the strut travel. If a strut limit is triggered, the hexapod is out of range. In this case, follow the directions of the controller to return the hexapod to a position within the range of motion. Refer to the HexGen® Programming Guide for more information.

1.3.3. Homing

The struts must each be homed in order for the hexapod to be controlled. Knowledge of the initial condition is necessary for the inverse kinematic calculations to be accurate. The home sequence involves moving each strut to its shortest position and then returning to the center of travel. Be sure that there are no crash conditions before homing. Refer to the HexGen® Programming User Guide for more information about how to initialize a hexapod.



WARNING: When enabled, each strut will make a small move to perform the commutation search. The motion is variable. Ensure that any fixturing is away from the stage to avoid a crash.

This page intentionally left blank.

Chapter 2: Mechanical Specifications and Installation



IMPORTANT: This manual tells you how to carefully and correctly use and operate the HEX150-140HL.

- Read all parts of this manual before you install or operate the hexapod or before you do maintenance to your system.
- To prevent injury to you and damage to the equipment, obey the precautions in this manual.
- All specifications and illustrations are for reference only and were complete and accurate as of the release of this manual. To find the newest information about this product, refer to www.aerotech.com.

If you do not understand the information in this manual, contact Aerotech Global Technical Support.

2.1. Unpacking and Handling the Hexapod

If any damage has occurred during shipping, report it immediately.



WARNING: It is the responsibility of the customer to safely and carefully lift and move the hexapod. If you are not careful, you could adversely affect the performance of the HEX150-140HL.

- Refer to [Section 1.2](#) for mass specifications.
- Be careful if or when you touch the struts and joints, Do not apply force or torque directly to these components.
- Do **NOT** use the struts or joints as lift points.
- Lift only by the platform or base. NEVER lift by the struts or joints.
- Make sure that all moving parts are secure before you move the HEX150-140HL. Unsecured moving parts may shift and cause bodily injury.

Carefully remove the HEX150-140HL from its protective shipping container. Gently set the hexapod on a smooth, flat, and clean surface. Use compressed nitrogen or clean, dry, oil-free air to remove any dust or debris that has collected during shipping.

Before you operate the hexapod, it is important to let it stabilize at room temperature for at least 12 hours. This will make sure that all of the alignments, preloads, and tolerances are the same as they were when tested at Aerotech.



IMPORTANT: Each HEX150-140HL has a label that lists the system part number and serial number. These numbers are necessary to maintain or update system hardware and software. Locate this label and record the information for later reference.

2.2. Dimensions

Figure 2-1: HEX150-140HL Dimensions

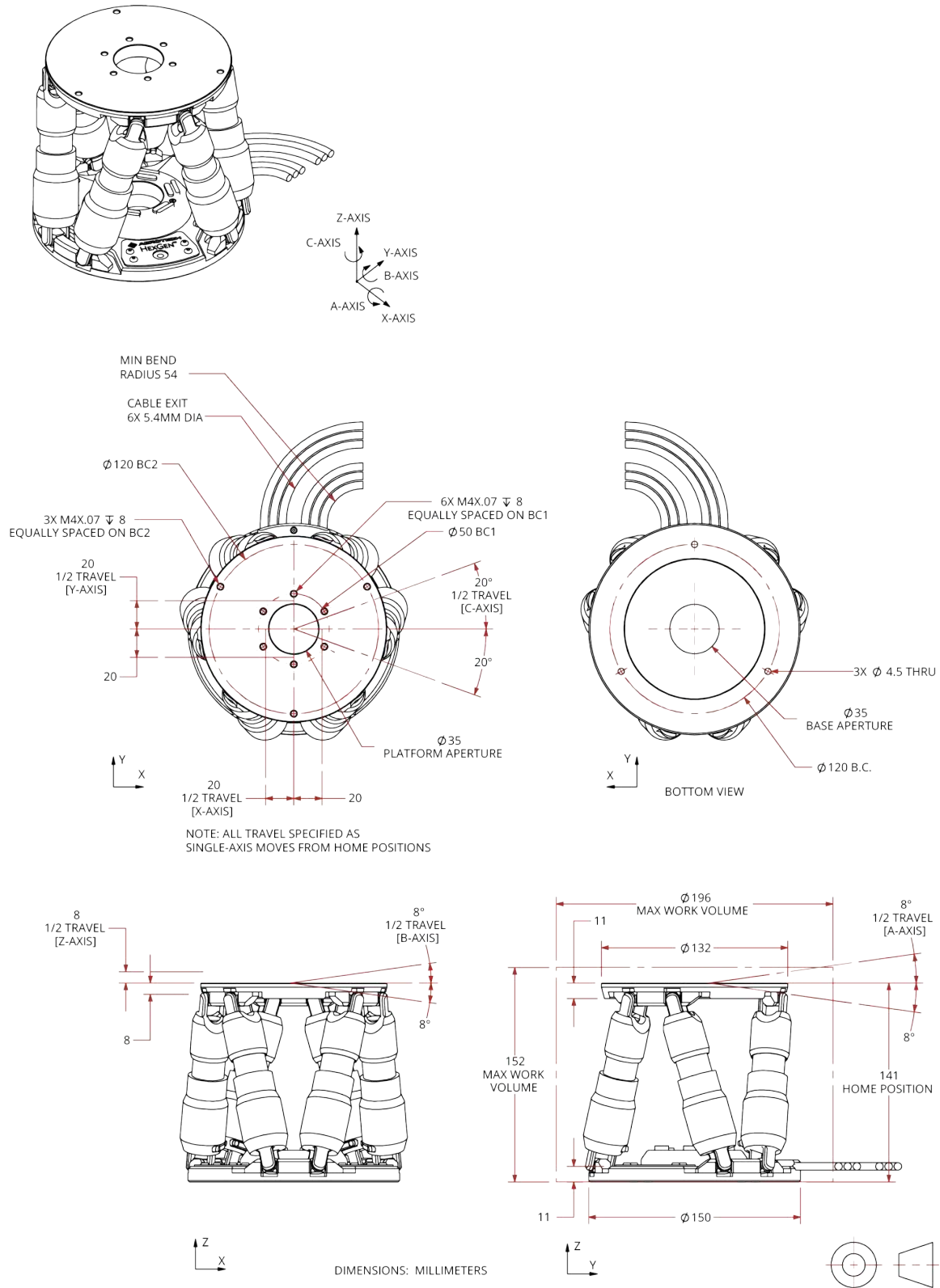

2.3. Securing the Hexapod to the Mounting Surface



WARNING: It is the responsibility of the customer to safely and carefully move and mount the hexapod. If you are not careful, you could adversely affect the performance of the HEX150-140HL.

The mounting surface must be flat and have adequate stiffness to achieve the maximum performance from the HEX150-140HL stage. When it is mounted to a non-flat surface, the stage can get distorted while the mounting screws are tightened. This distortion will decrease overall accuracy. Adjustments to the mounting surface must be done before the stage is secured.

Inspect the mounting surface for dirt or unwanted residue and clean if necessary. Use precision flatstones on the mounting surface to remove any burrs or high spots. Clean the mounting surface with a lint-free cloth and acetone or isopropyl alcohol and allow the cleaning solvent to completely dry. Gently place the stage on the mounting surface.



WARNING: The HEX150-140HL is precision machined and verified for flatness at the factory.

- Do not machine the HEX150-140HL housing. If you must machine a surface to achieve a required flatness, machine the mounting surface.
- Keep the use of shims to a minimum when you mount the HEX150-140HL to the mounting surface. The use of shims could reduce the rigidity of the system.



IMPORTANT: To maintain accuracy, the mounting surface must be flat to within 10 μm per 100 mm.

Three M4 mounting screws are required to mount the hexapod to the mounting surface. Refer to [Figure 2-2](#) or [Section 2.2. Dimensions](#) for mounting locations and [Table 2-1](#) for tightening torque values.

Tightening torque values for the mounting hardware are dependent on the properties of the surface to which the stage is being mounted. Values provided in [Table 2-1](#) are typical values and may not be accurate for your mounting surface. Refer to [Section 2.2](#) for specific model mounting locations and dimensions.

Table 2-1: Stage to Mounting Surface Hardware

Mounting Hardware	Typical Screw Torque
M4 or 8-32 SHCS (3 places)	2 N·m

Figure 2-2: Mounting Hole Locations



2.4. Attaching the Payload to the HEX150-140HL

Inspect the mounting surface for dirt or unwanted residue and clean if necessary. Clean the mounting surface with a lint free cloth and isopropyl alcohol and allow the cleaning solvent to completely dry.

Aerotech recommends that customers use a representative payload during start-up to prevent accidental damage to the stage and the payload. Proceed with the electrical installation and test the motion control system in accordance with the system documentation. Document all results for future reference. For information on electrical installation refer to [Chapter 3](#) and the documentation delivered with the stage.

The payload must be flat, rigid, and comparable to the stage in quality to maintain optimum performance.



IMPORTANT: For valid system performance, the mounting interface should be flat within 10 μm over the contact area.

Loads should be mounted close to the center of the hexapod, if possible, to reduce offset loading. The maximum load is based on the distance from the payload's center of mass to the center of the platform's mounting surface. External forces to the payload or hexapod platform should be considered when determining the maximum payload. Add process forces to the mass of the payload when determining the total applied force.

HexGen[®] hexapods can be mounted to a horizontal surface or a vertical surface. The orientation will also be critical in determining the load capacity. A horizontal mounting surface is recommended for maximum payload capabilities. Refer to the load curves that follow for allowable loading as a function of orientation and load offset.

Figure 2-3: HEX150-140HL Vertical Load Capabilities

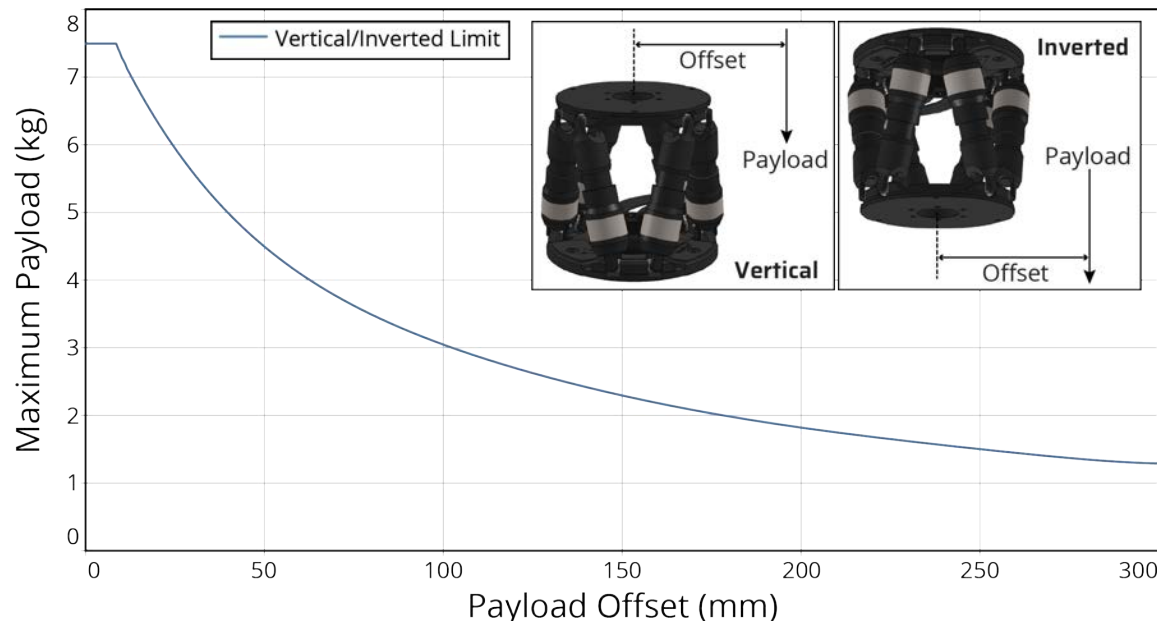
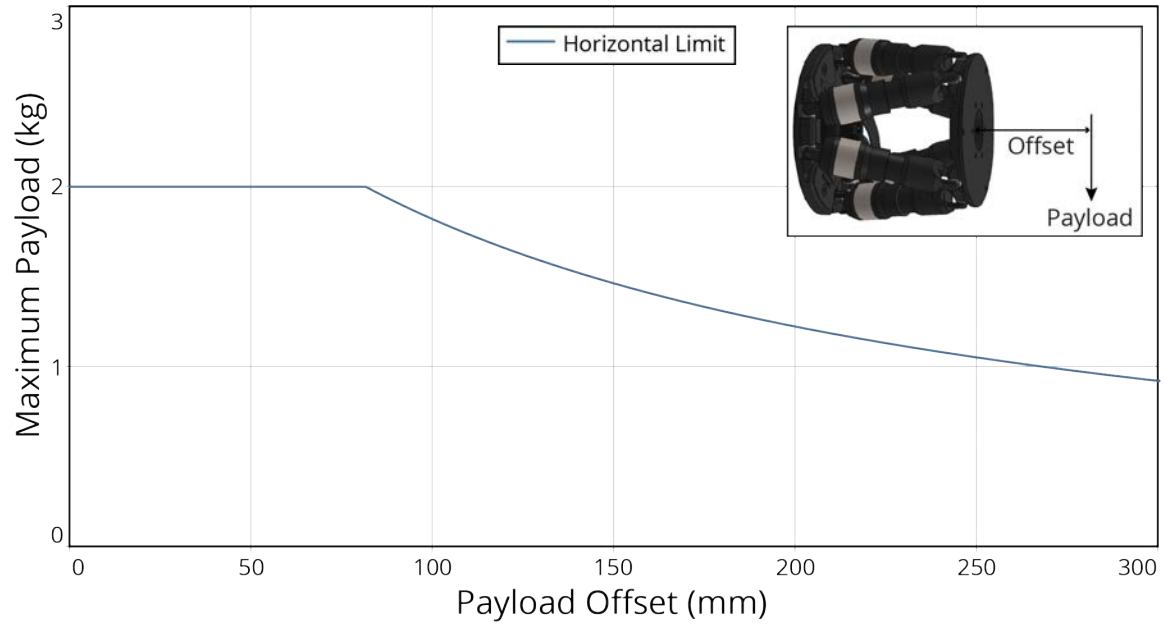

Figure 2-4: HEX150-140HL Horizontal Load Capabilities



Chapter 3: Electrical Specifications and Installation



DANGER: To decrease the risk of electrical shock, injury, death, and damage to the equipment, obey the precautions that follow.

- Electrical installation must be done by qualified personnel.
- Before you do maintenance to the equipment, disconnect the electrical power.
- Before you connect wires to this product, disconnect the electrical power.
- Restrict operator access to the base and tabletop while the system is connected to a power source.
- Applications that do require operator access to the HEX150-140HL must be restricted to qualified and trained personnel.
- Make sure that all components are grounded correctly and that they obey the local electrical safety requirements.
- It is the responsibility of the system integrator or qualified installer to determine and meet all safety and compliance requirements when they integrate the HEX150-140HL into a completed system.



WARNING: To prevent damage to the equipment and decrease the risk of electrical shock and injury, obey the precautions that follow.

- Only trained operators should operate this equipment.
- Use this product only in environments and operating conditions that are approved in this manual.

Electrical installation requirements will vary depending on product options. Installation instructions in this section are for HEX150-140HL stages equipped with standard Aerotech motors intended for use with an Aerotech motion control system. Contact Aerotech for further information regarding products that are otherwise configured.

Aerotech motion control systems are adjusted at the factory for optimum performance. When the HEX150-140HL is part of a complete Aerotech motion control system, setup usually involves connecting the HEX150-140HL to the appropriate drive chassis with the cables provided. Labels on the system components usually indicate the appropriate connections.

If system level integration was purchased, an electrical drawing showing system interconnects has been supplied with the system (separate from this documentation).

The electrical wiring from the motor and encoder are integrated at the factory. Refer to the sections that follow for standard motor wiring and connector pinouts.

3.1. Motor and Feedback Connectors



DANGER: To decrease the risk of electrical shock, injury, death, and damage to the equipment, obey the precautions that follow.

- Before you do maintenance to the equipment, disconnect the electrical power.
- Before you connect wires to this product, disconnect the electrical power.
- The stage controller must provide over-current and over-speed protection.
- Restrict access to the hexapod when it is connected to a power source.
- It is the responsibility of the system integrator or qualified installer to determine and meet all safety and compliance requirements when they integrate the HEX150-140HL into a completed system.



IMPORTANT: The protective ground connection must be properly installed to minimize the possibility of electric shock.

- Make sure that all components are grounded correctly and that they obey the local electrical safety requirements.
- The protective ground connection of the HEX150-140HL provides motor frame ground protection only.
- Additional grounding and safety precautions are required for applications requiring access to the stage while it is energized.

If the HEX150-140HL is built with standard Aerotech motors and encoders, it will arrive from the factory completely wired and assembled.

Table 3-1: Motor and Feedback Connector Pinout

Pin	Description	Connector
Case	Shield Connection	
1	Key (to make sure that the correct cable is plugged into the correct jack)	
2	COS- (Encoder Cosine-)	
3	SIN- (Encoder Sine-)	
4	MRK- (Encoder Marker-)	
5	Common ground	
6	Common ground	
7	-/CCW LMT (The limit signal that shows the maximum permitted machine travel in negative or counterclockwise encoder counts.)	
8	Reserved	
9	Reserved	
10	Frame Ground	
11	Motor Phase A	
12	Motor Phase B	
13	Motor Phase C	
14	COS+ (Encoder Cosine+)	
15	SIN+ (Encoder Sine+)	
16	MRK+ (Encoder Marker+)	
17	5V Power Supply Input	
18	Reserved	
19	+/CW LMT (The limit signal that shows the maximum permitted machine travel in positive or clockwise encoder counts.)	
20	Reserved	
21	Reserved	
22	Frame Ground	
23	Motor Phase A	
24	Motor Phase B	
25	Motor Phase C	

Table 3-2: Mating Connector Part Numbers

Mating Connector	Aerotech P/N	Third Party P/N
25-Socket D-Connector	ECK00300	FCI DB25S064TLF
Backshell	ECK00656	Amphenol 17E-1726-2

3.2. Motor and Feedback Wiring



DANGER: To decrease the risk of electrical shock, injury, death, and damage to the equipment, obey the precautions that follow.

- Make sure that all components are grounded correctly and that they obey the local electrical safety requirements.
- It is the responsibility of the system integrator or qualified installer to determine and meet all safety and compliance requirements when they integrate the HEX150-140HL into a completed system.
- Restrict access to the hexapod when it is connected to a power source.

Shielded cables are required for the motor and feedback connections.

Figure 3-1: Motor and Feedback Wiring

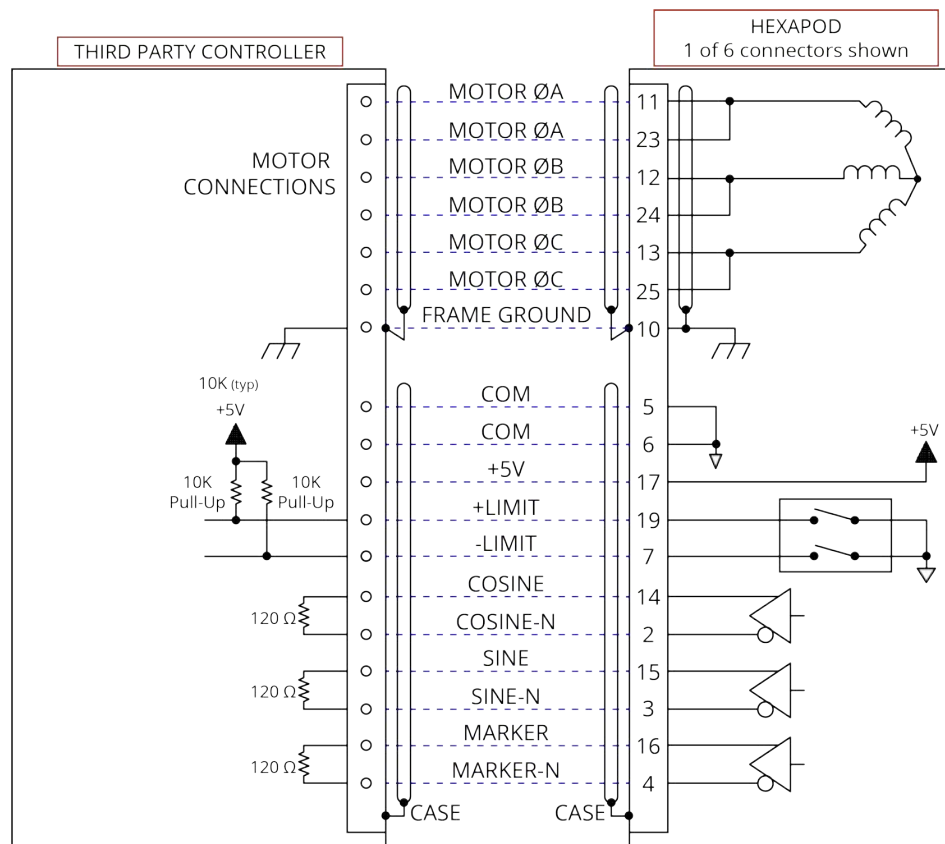

3.3. Motor and Feedback Specifications

Table 3-3: Encoder Specifications

	Specifications
Supply Voltage	5 V \pm 10%
Supply Current	175 mA
	425 mA
Output Signals	Line Driver Type (Incremental Rotary Encoder): into 120 Ω load (differential signals SIN+, SIN-, COS+, and COS-)
	Line Driver Type (Incremental Rotary Encoder): into 120 Ω load (differential signals SIN+, SIN-, COS+, and COS-)
	Serial Output (Absolute Linear Encoder): Biss C (unidirectional)

Table 3-4: Limit Switch Specifications

	Specifications
Supply Voltage	5 V \pm 5%
Supply Current	25 mA
Output Type	Open Collector
Output Voltage	5 V
Output Current	10 mA (sinking)
Output Polarity	Normally Closed (NC)
	• Sinks current to ground (Logic "0") when not in limit
	• High impedance (Logic "1") when in limit
	• Requires external pull-up to +5 V (10 k Ω recommended)
Note: If the HEX150-140HL is driven beyond the electrical limit, it will encounter a mechanical stop. Impacting the mechanical stop could cause damage to the stage even at low speeds.	

Table 3-5: HEX150-140HL Motor Specifications

		Hexapod Motor
Performance Specifications ^(1,5)		
Stall Torque, Cont. ⁽²⁾	N·m	0.037
Peak Torque ⁽³⁾	N·m	0.149
Electrical Specifications ⁽⁵⁾		
BEMF Const., line-line, Max	$V_{pk}/krpm$	2.80
Continuous Current, Stall ⁽²⁾	A_{pk}	1.6
	A_{rms}	1.1
Peak Current, Stall ⁽²⁾	A_{pk}	6.4
	A_{rms}	4.5
Torque Constant ^(4, 9)	$N·m/A_{pk}$	0.023
	$N·m/A_{rms}$	0.033
Motor Constant ^(2, 4)	$N·m/\sqrt{W}$	0.016
Resistance, 25°C, line-line	Ω	2.20
Inductance, line-line	mH	0.83
Maximum Bus Voltage	V_{DC}	60
Thermal Resistance	$^{\circ}C/W$	14.01
Number of Poles	--	8
1. Performance is dependent upon heat sink configuration, system cooling conditions, and ambient temperature. 2. Values shown @ 105°C rise above a 25 °C ambient temperature. 3. Peak force assumes correct rms current; consult Aerotech. 4. Torque constant and motor constant specified at stall. 5. All performance and electrical specifications $\pm 10\%$. 6. Maximum winding temperature is 130 °C 7. Ambient operating temperature range 0 °C - 25 °C; consult Aerotech for performance in elevated ambient temperatures. 8. All Aerotech amplifiers are rated A_{pk} ; use torque constant in $N·m/A_{pk}$ when sizing.		

Table 3-6: HEX150-140HL Rotary Encoder Specifications

	Fundamental Signal Period
Fundamental Resolution	650 Lines/Rev

3.4. Machine Direction

Aerotech stages are configured to have positive and negative "machine" directions. The machine direction defines the phasing of the feedback and motor signals and is dictated by the hexapod wiring (refer to [Section 3.5](#) for Motor and Feedback phasing information). Programming direction of a stage is set by the controller that is used to move the stage. Programming direction is typically selectable in the controller, while machine direction is hardwired in the hexapod.

Figure 3-2: Machine Direction

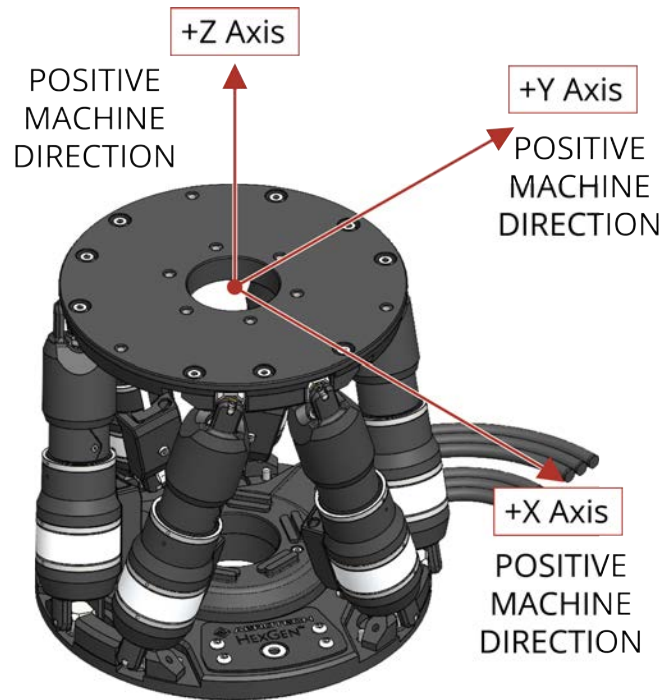

3.5. Feedback Phasing

Motor phase voltage is measured relative to the virtual wye common point.

Figure 3-3: Encoder Phasing Reference Diagram (Standard)

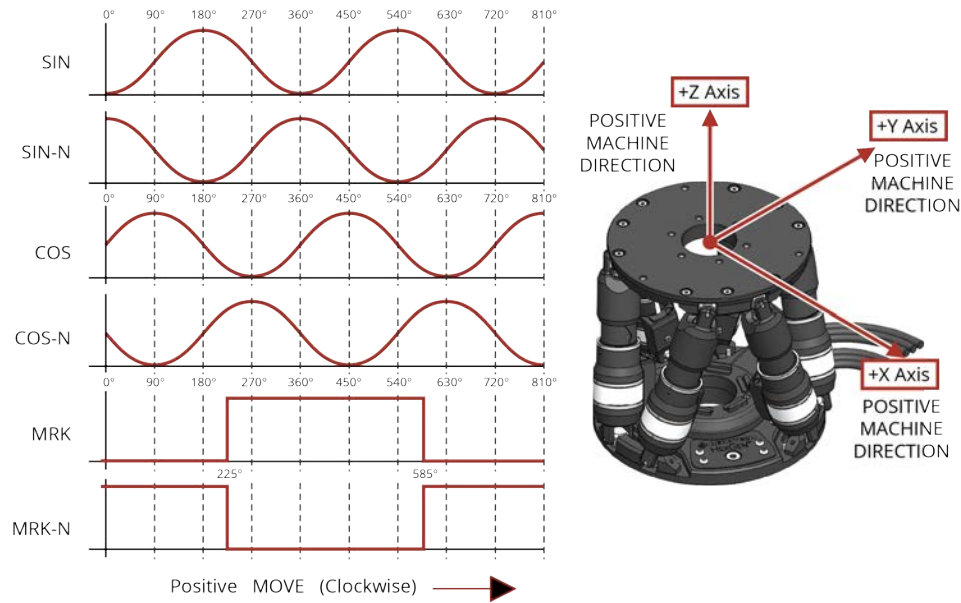

Chapter 4: Maintenance



DANGER: To decrease the risk of electrical shock, injury, death, and damage to the equipment, obey the precautions that follow.

- All service and maintenance must be done by approved personnel.
- Before you do maintenance to the equipment, disconnect the electrical power.
- Before you connect wires to this product, disconnect the electrical power.
- Restrict access to the hexapod when it is connected to a power source.

4.1. Service and Inspection Schedule

Inspect and clean the HEX150-140HL once per month. A longer or shorter inspection interval may be required depending on the specific application, and conditions such as the duty cycle, speed, and environment.

Monthly inspections should include but not be limited to:

- Re-tighten loose connectors.
- Replace or repair damaged cables.
- Clean the HEX150-140HL and any components and cables as needed.
- Repair any damage before operating the HEX150-140HL.

4.2. Cleaning and Lubrication



WARNING: Do not scratch any bearing surfaces when you clean or lubricate the hexapod.

Cleaning

Before you use a cleaning solvent on any part of the HEX150-140HL, blow away small particles and dust with nitrogen or, less preferably, clean, dry, compressed air.

Any external metal surface of the HEX150-140HL can be cleaned with isopropyl alcohol on a lint-free cloth.

Lubrication

Only use the grease specified in table as other greases could be incompatible.

Table 4-1: Grease Specifications

Location	Grease
Angular Contact Bearings	Kluberplex BEM 34-132
Ballscrew	Kluberplex BEM 34-132
U-Joints	Kluber Isoflex Topas NCA 51
Thrust Bearings	Kluberplex BEM 34-132

If the application process uses only a small portion of travel for most of the duty cycle, periodically drive the stage through full travel to redistribute the lubrication in the bearings. The motor is completely non-contact and requires no lubrication.

4.3. Troubleshooting

Table 4-2: Troubleshooting

Symptom	Possible Causes and Solutions
Strut will not move	A Cable is Disconnected: Check the cables for connections and damage.
	Limit or Controller Fault: Check the controller for faults. Refer to the controller and software documentation.
Strut moves uncontrollably	Encoder Signal Connection or the Motor Signal Connection: Check to make sure that the cable connections are secure. Refer to the Section 3.2. Motor and Feedback Wiring
Axes are unstable or squeal	Incorrect Gains: Refer to controller documentation

Appendix A: Warranty and Field Service

Aerotech, Inc. warrants its products to be free from harmful defects caused by faulty materials or poor workmanship for a minimum period of one year from date of shipment from Aerotech. Aerotech's liability is limited to replacing, repairing or issuing credit, at its option, for any products that are returned by the original purchaser during the warranty period. Aerotech makes no warranty that its products are fit for the use or purpose to which they may be put by the buyer, whether or not such use or purpose has been disclosed to Aerotech in specifications or drawings previously or subsequently provided, or whether or not Aerotech's products are specifically designed and/or manufactured for buyer's use or purpose. Aerotech's liability on any claim for loss or damage arising out of the sale, resale, or use of any of its products shall in no event exceed the selling price of the unit.

THE EXPRESS WARRANTY SET FORTH HEREIN IS IN LIEU OF AND EXCLUDES ALL OTHER WARRANTIES, EXPRESSED OR IMPLIED, BY OPERATION OF LAW OR OTHERWISE. IN NO EVENT SHALL AEROTECH BE LIABLE FOR CONSEQUENTIAL OR SPECIAL DAMAGES.

Return Products Procedure

Claims for shipment damage (evident or concealed) must be filed with the carrier by the buyer. Aerotech must be notified within thirty (30) days of shipment of incorrect material. No product may be returned, whether in warranty or out of warranty, without first obtaining approval from Aerotech. No credit will be given nor repairs made for products returned without such approval. A "Return Materials Authorization (RMA)" number must accompany any returned product(s). The RMA number may be obtained by calling an Aerotech service center or by submitting the appropriate request available on our website (www.aerotech.com). Products must be returned, prepaid, to an Aerotech service center (no C.O.D. or Collect Freight accepted). The status of any product returned later than thirty (30) days after the issuance of a return authorization number will be subject to review.

Visit [Global Technical Support Portal](#) for the location of your nearest Aerotech Service center.

Returned Product Warranty Determination

After Aerotech's examination, warranty or out-of-warranty status will be determined. If upon Aerotech's examination a warranted defect exists, then the product(s) will be repaired at no charge and shipped, prepaid, back to the buyer. If the buyer desires an expedited method of return, the product(s) will be shipped collect. Warranty repairs do not extend the original warranty period.

Fixed Fee Repairs - Products having fixed-fee pricing will require a valid purchase order or credit card particulars before any service work can begin.

All Other Repairs - After Aerotech's evaluation, the buyer shall be notified of the repair cost. At such time the buyer must issue a valid purchase order to cover the cost of the repair and freight, or authorize the product(s) to be shipped back as is, at the buyer's expense. Failure to obtain a purchase order number or approval within thirty (30) days of notification will result in the product(s) being returned as is, at the buyer's expense.

Repair work is warranted for ninety (90) days from date of shipment. Replacement components are warranted for one year from date of shipment.

Rush Service

At times, the buyer may desire to expedite a repair. Regardless of warranty or out-of-warranty status, the buyer must issue a valid purchase order to cover the added rush service cost. Rush service is subject to Aerotech's approval.

On-site Warranty Repair

If an Aerotech product cannot be made functional by telephone assistance or by sending and having the customer install replacement parts, and cannot be returned to the Aerotech service center for repair, and if Aerotech determines the problem could be warranty-related, then the following policy applies:

Aerotech will provide an on-site Field Service Representative in a reasonable amount of time, provided that the customer issues a valid purchase order to Aerotech covering all transportation and subsistence costs. For warranty field repairs, the customer will not be charged for the cost of labor and material. If service is rendered at times other than normal work periods, then special rates apply.

If during the on-site repair it is determined the problem is not warranty related, then the terms and conditions stated in the following "On-Site Non-Warranty Repair" section apply.

On-site Non-Warranty Repair

If any Aerotech product cannot be made functional by telephone assistance or purchased replacement parts, and cannot be returned to the Aerotech service center for repair, then the following field service policy applies:

Aerotech will provide an on-site Field Service Representative in a reasonable amount of time, provided that the customer issues a valid purchase order to Aerotech covering all transportation and subsistence costs and the prevailing labor cost, including travel time, necessary to complete the repair.

Service Locations

<http://www.aerotech.com/contact-sales.aspx?mapState=showMap>

USA, CANADA, MEXICO

Aerotech, Inc.
Global Headquarters

CHINA

Aerotech China
Full-Service Subsidiary

GERMANY

Aerotech Germany
Full-Service Subsidiary

TAIWAN

Aerotech Taiwan
Full-Service Subsidiary

UNITED KINGDOM

Aerotech United Kingdom
Full-Service Subsidiary

Appendix B: Revision History

Revision	Description
2.00	General update
1.00	New Manual

This page intentionally left blank.

Index

	Z				
2006/42/EC		9			
2011/65/EU		9			
	A				
Absolute Linear Encoder		27			
Accuracy and Temperature Effects		12			
Altitude		12			
Ambient Temperature		12			
Attaching the Payload		21			
	B				
Basic Specifications		13			
	C				
cleaning					
mounting surface		19			
solvents		31			
Cleaning		31			
Cleaning Solvents					
Recommended		31			
	D				
Digital Output Encoder		27			
Dimensions		18			
Directive 2006/42/EC		9			
	E				
Electrical Installation		23			
Electrical Specifications					
S-50		28			
EN 60204-1 2010		9			
EN ISO 12100 2010		9			
Encoder Specifications		27			
EU 2015/863		9			
	H				
Handling the Hexapod		17			
Horizontal Load Capabilities		22			
Humidity		12			
	I				
			Incremental Encoder		27
			Incremental Rotary Encoder		27
			inspect		31
			Inspection		31
			isopropyl alcohol		31
	L				
			label		17
			Limit Switch Specifications		27
			load capacity		21
			Lubrication		31
	M				
			Maintenance		31
			Mounting Hole Locations		20
			mounting surface		
			cleaning		19
			securing stage		19
	P				
			part number		17
			Performance Specifications		
			S-50		28
			Protection Rating		12
			protective ground connection		24
	R				
			Rotary Encoder		27
	S				
			S-50		
			Electrical Specifications		28
			S-50 Performance Specifications		28
			Securing the hexapod to the Mounting Surface		19
			serial number		17
			Service and Inspection Schedule		31
			solvents		31
			stabilizing stage		17
			stage		
			distortion		19
			stabilizing		17

T	
Table of Contents	3
Temperature Effects	12
U	
Unpacking and Handling the Hexapod	17
Use	12
V	
Vertical Load Capabilities	21
Vibration	12
W	
Warranty and Field Service	33